



Micro Commercial Components
 21201 Itasca Street Chatsworth
 CA 91311
 Phone: (818) 701-4933
 Fax: (818) 701-4939

FR8A THRU FR8M

Features

- Low Leakage
- Low Forward Voltage Drop
- High Current Capability
- Fast Switching Speed For High Efficiency

Maximum Ratings

- Operating Temperature: -55°C to +150°C
- Storage Temperature: -55°C to +150°C

MCC Part Number	Maximum Recurrent Peak Reverse Voltage	Maximum RMS Voltage	Maximum DC Blocking Voltage
FR8A	50V	35V	50V
FR8B	100V	70V	100V
FR8D	200V	140V	200V
FR8G	400V	280V	400V
FR8J	600V	420V	600V
FR8K	800V	560V	800V
FR8M	1000V	700V	1000V

**8 Amp Fast
Recovery Rectifier
50 to 1000 Volts**

DO-214AB (SMCJ) (Round Lead)

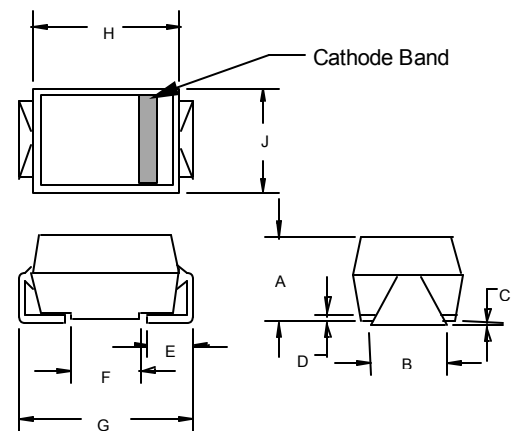

Electrical Characteristics @ 25°C Unless Otherwise Specified

Parameter	Symbol	Value	Conditions
Average Forward Current	$I_{F(AV)}$	8 A	$T_A = 55^\circ\text{C}$
Peak Forward Surge Current	I_{FSM}	300A	8.3ms, half sine
Maximum Instantaneous Forward Voltage	V_F	1.30V	$I_{FM} = 8.0\text{A}; T_A = 25^\circ\text{C}$
Maximum DC Reverse Current At Rated DC Blocking Voltage	I_R	10 μA 50 μA	$T_A = 25^\circ\text{C}$ $T_A = 100^\circ\text{C}$
Maximum Reverse Recovery Time	T_{rr}	150ns 250ns 500ns	$I_F = 0.5\text{A}, I_R = 1.0\text{A}, I_{rr} = 0.25\text{A}$

DIM	INCHES		MM		NOTE
	MIN	MAX	MIN	MAX	
A	.200	.214	5.08	5.43	
B	.177	.203	4.70	5.30	
C	.002	.005	.05	.13	
D	—	.02	—	.51	
E	.053	.067	1.35	1.70	
F	.168	.179	4.27	4.55	
G	.320	.330	8.13	8.38	
H	.239	.243	6.08	6.18	
J	.234	.240	5.95	6.10	

SUGGESTED SOLDER PAD LAYOUT

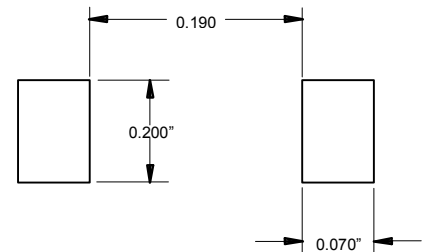

*Pulse Test: Pulse Width 300 μsec , Duty Cycle 1%

FR8A thru FR8M

Figure 1
Typical Forward Characteristics

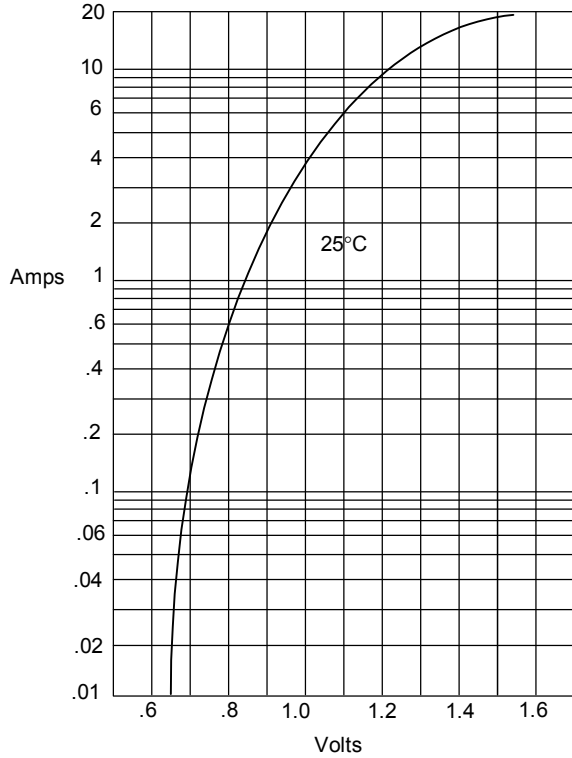

Instantaneous Forward Current - Amperes versus
Instantaneous Forward Voltage - Volts

Figure 2
Forward Derating Curve

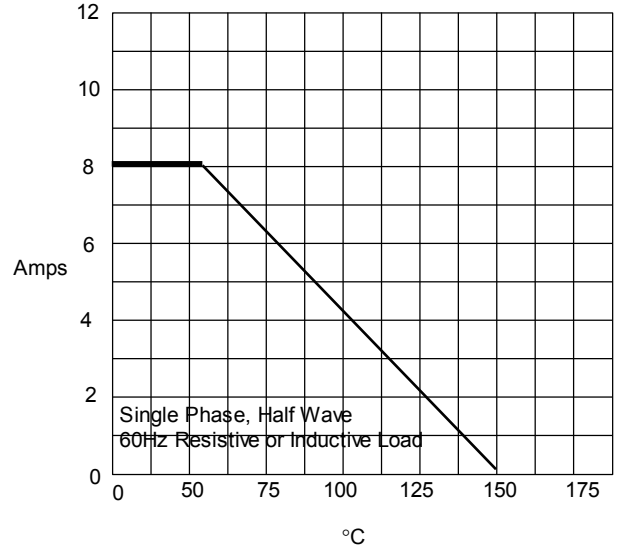
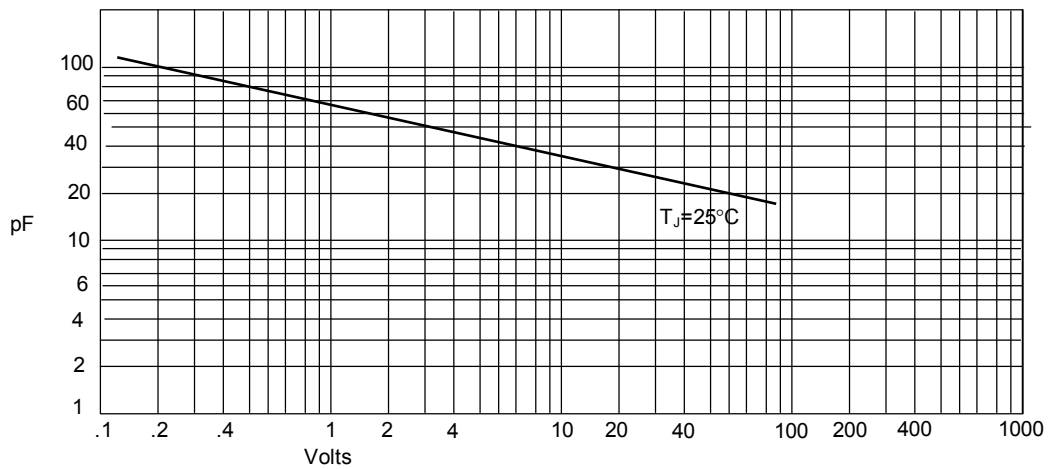

Figure 3
Junction Capacitance



Junction Capacitance - pF versus
Reverse Voltage - Volts

FR8A thru FR8M

Figure 4
Peak Forward Surge Current

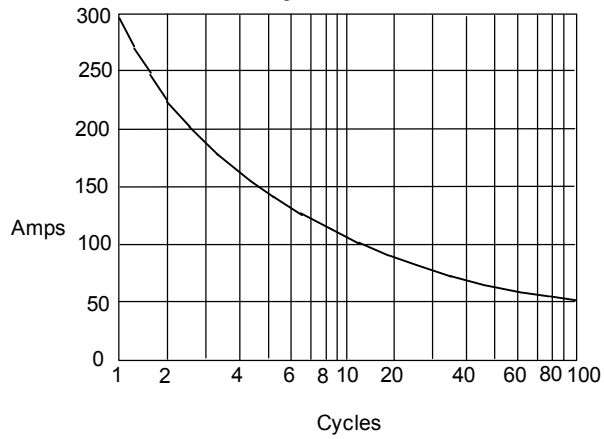

Peak Forward Surge Current - Amperes versus
Number Of Cycles At 60Hz - Cycles

Figure 5
Reverse Recovery Time Characteristic And Test Circuit Diagram

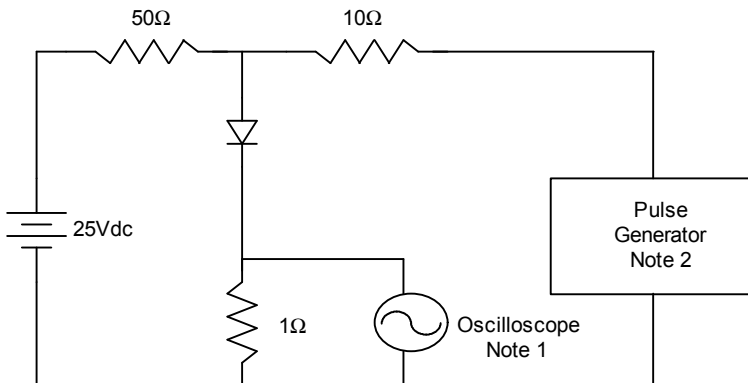

- Notes:
1. Rise Time = 7ns max.
Input impedance = 1 megohm, 22pF
 2. Rise Time = 10ns max.
Source impedance = 50 ohms
 3. Resistors are non-inductive

