

SPECIAL FEATURES

- 16384 bits Electrically Programmable Read Only Memory (EPROM) communicates with the economy of one signal plus ground
- EPROM partitioned into sixty-four 256-bit pages for randomly accessing packetized data records
- Each memory page can be permanently write-protected to prevent tampering
- Device is an “add only” memory where additional data can be programmed into EPROM without disturbing existing data
- Architecture allows software to patch data by superseding an old page in favor of a newly programmed page
- Reduces control, address, data, power, and programming signals to a single data pin
- 8-bit family code specifies DS1985 communications requirements to reader
- Reads over a wide voltage range of 2.8V to 6.0V from -40°C to +85°C; programs at 11.5V to 12.0V from -40°C to +85°C

COMMON iButton FEATURES

- Unique, factory-lasered and tested 64-bit registration number (8-bit family code + 48-bit serial number + 8-bit CRC tester) assures absolute traceability because no two parts are alike

- Multidrop controller for MicroLAN
- Digital identification and information by momentary contact
- Chip-based data carrier compactly stores information
- Data can be accessed while affixed to object
- Economically communicates to bus master with a single digital signal at 16.3k bits per second
- Standard 16 mm diameter and 1-Wire™ protocol ensure compatibility with iButton family
- Button shape is self-aligning with cup-shaped probes
- Durable stainless steel case engraved with registration number withstands harsh environments
- Easily affixed with self-stick adhesive backing, latched by its flange, or locked with a ring pressed onto its rim
- Presence detector acknowledges when reader first applies voltage
- Meets UL#913 (4th Edit.); Intrinsically Safe Apparatus, Approved under Entity Concept for use in Class I, Division 1, Group A, B, C and D Locations (application pending)

F3 MICROCAN™

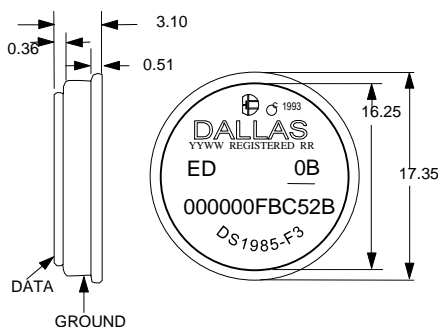

F5 MICROCAN™

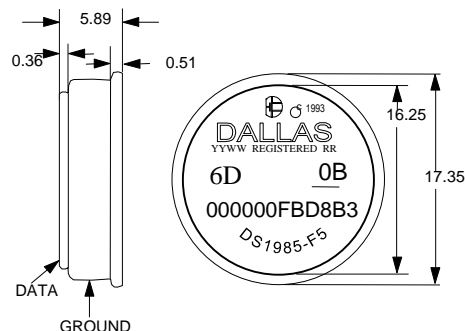

All dimensions shown in millimeters.

ORDERING INFORMATION

DS1985-F3	F3 MicroCan
DS1985-F5	F5 MicroCan

EXAMPLES OF ACCESSORIES

DS9096P	Self-Stick Adhesive Pad
DS9101	Multi-Purpose Clip
DS9093RA	Mounting Lock Ring
DS9093F	Snap-In Fob
DS9092	iButton Probe

iButton DESCRIPTION

The DS1985 16-kbit Add-Only iButton is a rugged read/write data carrier that identifies and stores relevant information about the product or person to which it is attached. This information can be accessed with minimal hardware, for example a single port pin of a microcontroller. The DS1985 consists of a factory-lasered registration number that includes a unique 48-bit serial number, an 8-bit CRC, and an 8-bit Family Code (OBH) plus 16k bit of EPROM which is user-programmable. The power to program and read the DS1985 is derived entirely from the 1-Wire communication line. Data is transferred serially via the 1-Wire protocol which requires only a single data lead and a ground return. The entire device can be programmed and then write-protected if desired. Alternatively, the part may be programmed multiple times with new data being appended to, but not overwriting, existing data with each subsequent programming of the device. Note: Individual bits can be changed only from a logical 1 to a logical 0, never from a logical 0 to a logical 1. A provision is also included for indicating that a certain page or pages of data are no longer valid and have been replaced with new or updated data that is now residing at an alternate page address. This page address redirection allows software to patch data and enhance the flexibility of the device as a standalone database. The 48-bit serial number that is factory-lasered into each DS1985 provides a guaranteed unique identity which allows for absolute traceability. The durable MicroCan package is highly resistant to harsh environments such as dirt, moisture, and shock. Its compact button-shaped profile is self-aligning with cup-shaped receptacles, allowing the DS1985 to be used easily by human operators or automatic equipment. Accessories permit the DS1985 to be mounted on printed circuit boards, plastic key fobs, photo-ID badges, ID bracelets, and many other objects. Applications include work-in-progress tracking, electronic travelers, access control, storage of calibration constants, and debit tokens.

OVERVIEW

The block diagram in Figure 1 shows the relationships between the major control and memory sections of the DS1985. The DS1985 has three main data components: 1) 64-bit lasered ROM, 2) 16384-bits EPROM Data Memory, and 3) 704-bits EPROM Status Memory. The device derives its power for read operations entirely from the 1-Wire communication line by storing energy on an internal capacitor during periods of time when the signal line is high and continues to operate off of this “parasite” power source during the low times of the 1-Wire line until it returns high to replenish the parasite (capacitor) supply. During programming, 1-Wire communication occurs at normal voltage levels and then is pulsed momentarily to the programming voltage to cause the selected EPROM bits to be programmed. The 1-Wire line must be able to provide 12 volts and 10 milliamperes to adequately program the EPROM portions of the part. Whenever programming voltages are present on the 1-Wire line a special high voltage detect circuit within the DS1985 generates an internal logic signal to indicate this condition. The hierarchical structure of the 1-Wire protocol is shown in Figure 2. The bus master must first provide one of the four ROM Function Commands, 1) Read ROM, 2) Match ROM, 3) Search ROM, 4) Skip ROM. These commands operate on the 64-bit lasered ROM portion of each device and can singulate a specific device if many are present on the 1-Wire line as well as indicate to the bus master how many and what types of devices are present. The protocol required for these ROM Function Commands is described in Figure 8. After a ROM Function Command is successfully executed, the memory functions that operate on the EPROM portions of the DS1985 become accessible and the bus master may issue any one of the

The 1-Wire CRC of the lasered ROM is generated using the polynomial $X^8 + X^5 + X^4 + 1$. Additional information about the Dallas Semiconductor 1-Wire Cyclic Redundancy Check is available in the Book of DS19xx iButton Standards. The shift register acting as the CRC accumulator is initialized to 0. Then starting with the least significant bit of the family code, one bit at a time is shifted in. After the 8th bit of the family code has been entered, then the serial number is entered. After the 48th bit of the serial number has been entered, the shift register contains the CRC value. Shifting in the 8 bits of CRC should return the shift register to all 0s.

HIERARCHICAL STRUCTURE FOR 1-WIRE PROTOCOL Figure 2

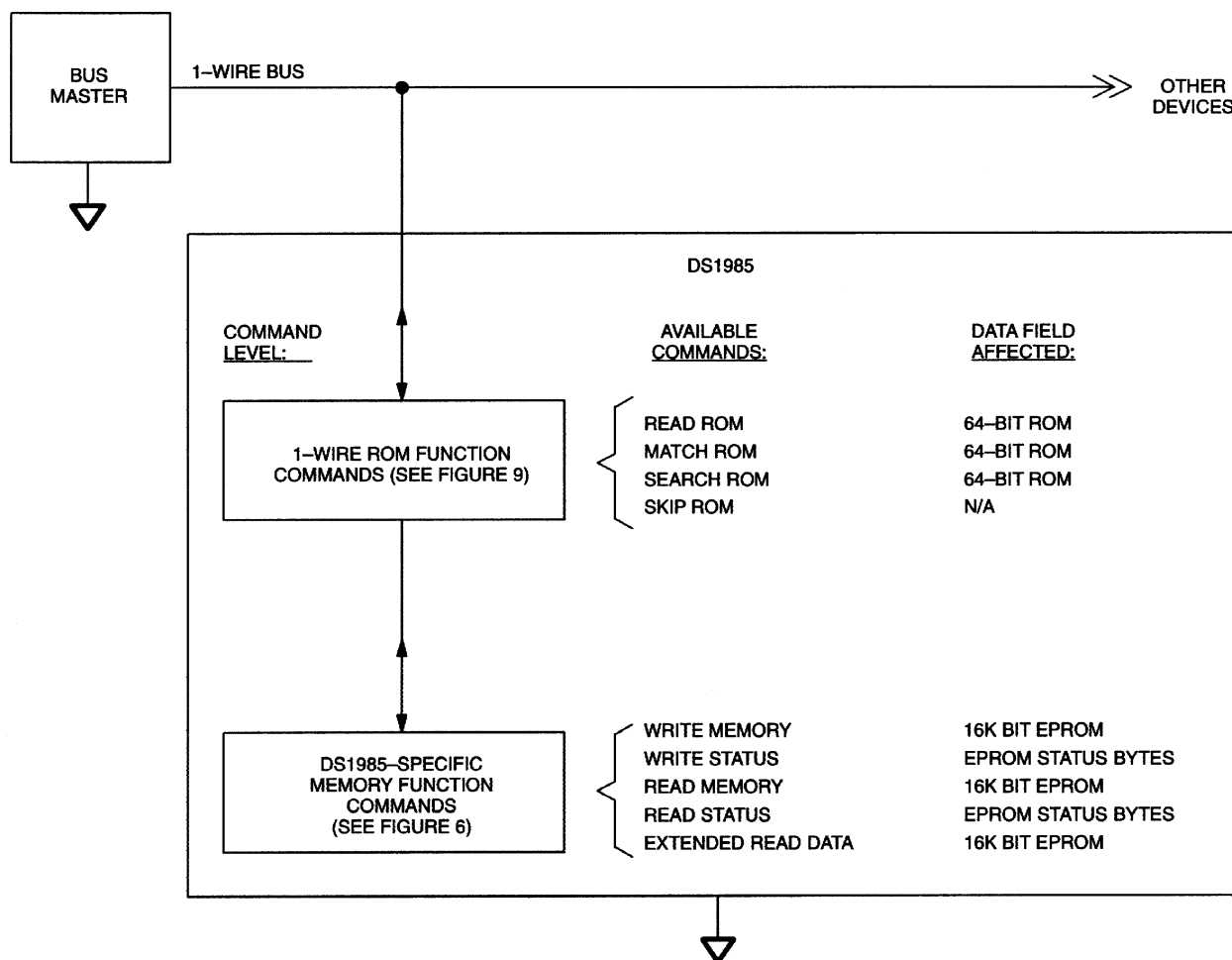

64-BIT LASERED ROM Figure 3

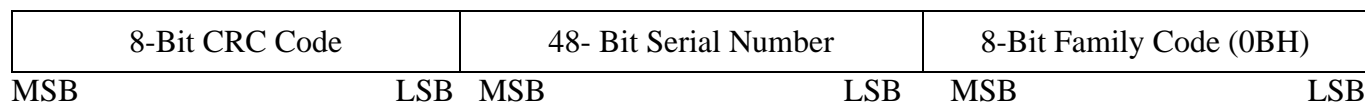

16384 BITS EPROM

The memory map in Figure 4 shows the 16384 bits EPROM section of the DS1985 which is configured as 64 pages of 32 bytes each. The 8-bit scratchpad is an additional register that acts as a buffer when programming the memory. Data is first written to the scratchpad and then verified by reading a 16-bit CRC from the DS1985 that confirms proper receipt of the data and address. If the buffer contents are correct, a programming voltage should be applied and the byte of data will be written into the selected address in memory. This process ensures data integrity when programming the memory. The details for reading and programming the 16384 bits EPROM portion of the DS1985 are given in the Memory Function Commands section.

EPROM STATUS BYTES

In addition to the 16384 bits of data memory the DS1985 provides 704 bits of Status Memory accessible with separate commands.

The EPROM Status Bytes can be read or programmed to indicate various conditions to the software interrogating the DS1985. The first 8 bytes of the EPROM Status Memory (addresses 000 to 007H) contain the Write Protect Page bits which inhibit programming of the corresponding page in the 16384-bit main memory area if the appropriate write protection bit is programmed. Once a bit has been programmed in the Write Protect Page section of the Status Memory, the entire 32-byte page that corresponds to that bit can no longer be altered but may still be read.

The next 8 bytes of the EPROM Status Memory (addresses 020 to 027H) contain the Write Protect bits which inhibit altering the Page Address Redirection Byte corresponding to each page in the 16384-bit main memory area.

The following 8 bytes within the EPROM Status Memory (addresses 040 to 047H) are reserved for use by the iButton operating software TMEX. Their purpose is to indicate which memory pages are already in use. Originally, all of these bits are unprogrammed, indicating that the device does not store any data. As soon as data is written to any page of the device under control of TMEX, the bit inside this bitmap corresponding to that page will be programmed to 0, marking this page as used. These bits are application flags only and have no impact on the internal logic of the DS1985.

The next 64 bytes of the EPROM Status Memory (addresses 100H to 13FH) contain the Page Address Redirection Bytes which indicate if one or more of the pages of data in the 16384 bits EPROM section have been invalidated by software and redirected to the page address contained in the appropriate redirection byte. The hardware of the DS1985 makes no decisions based on the contents of the Page Address Redirection Bytes. These additional bytes of Status EPROM allow for the redirection of an entire page to another page address, indicating that the data in the original page is no longer considered relevant or valid. With EPROM technology, bits within a page can be changed from a logical 1 to a logical 0 by programming, but cannot be changed back. Therefore, it is not possible to simply rewrite a page if the data requires changing or updating, but with space permitting, an entire page of data can be redirected to another page within the DS1985 by writing the one's complement of the new page address into the Page Address Redirection Byte that corresponds to the original (replaced) page.

This architecture allows the user's software to make a "data patch" to the EPROM by indicating that a particular page or pages should be replaced with those indicated in the Page Address Redirection Bytes. To leave an authentic audit trail of data patches, it is recommended to also program the write protect bit of the Page Address Redirection Byte, after the page redirection is programmed. Without this protection, it is still possible to modify the Page Address Redirection Byte, making it point to a different memory page than the true one.

If a Page Address Redirection Byte has a FFH value, the data in the main memory that corresponds to that page is valid. If a Page Address Redirection Byte has some other hex value, the data in the page corresponding to that redirection byte is invalid, and the valid data can now be found at the one's complement of the page address indicated by the hex value stored in the associated Page Address Redirection Byte. A value of FDH in the redirection byte for page 1, for example, would indicate that the updated data is now in page 2. The details for reading and programming the EPROM status memory portion of the DS1985 are given in the Memory Function Commands section.

DS 1985 MEMORY MAP Figure 4

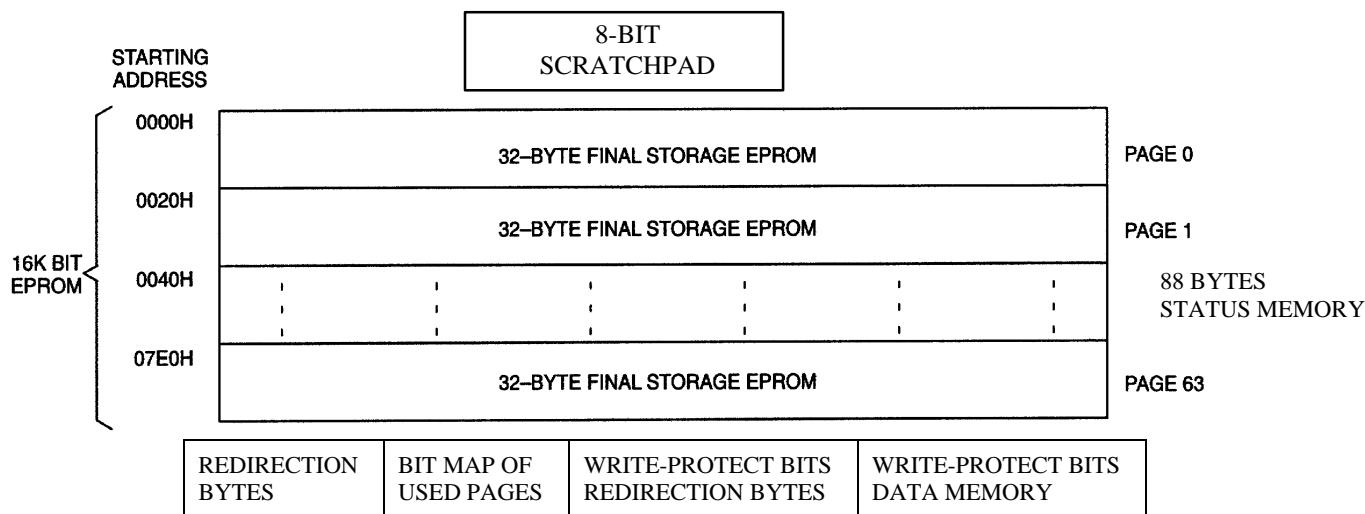

STATUS MEMORY MAP

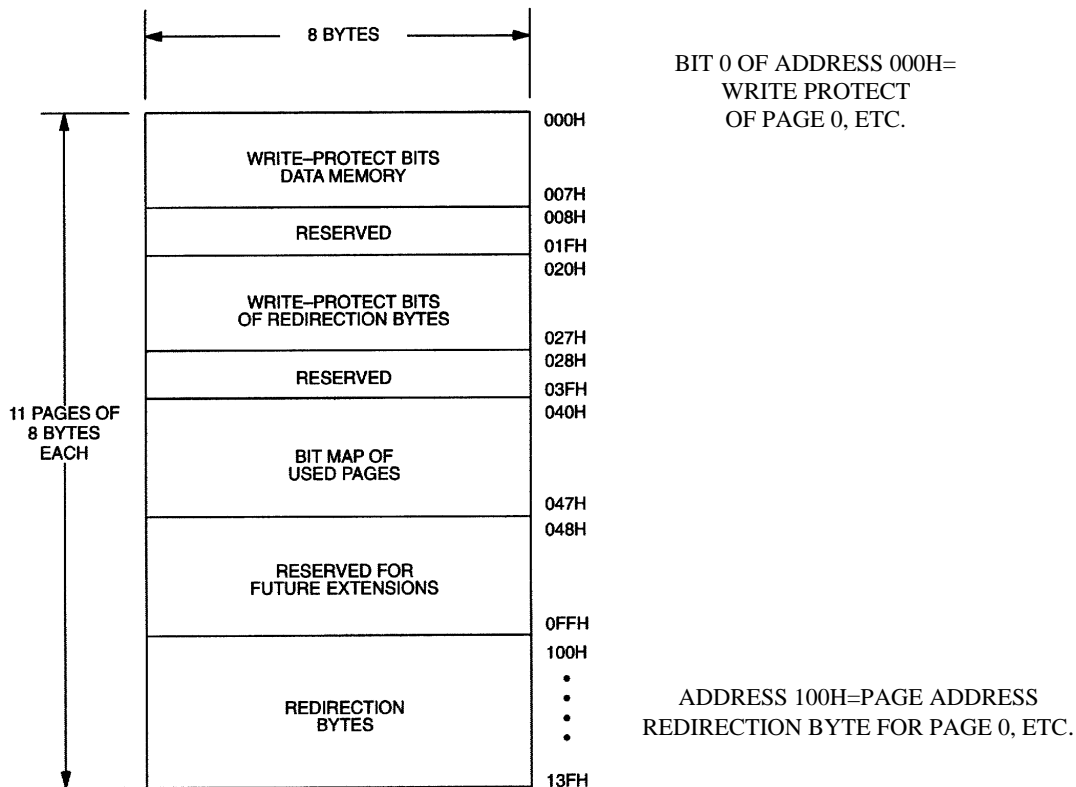

The Status Memory address range of the DS1985 extends from 000 to 13FH. The memory locations 008H to 01FH, 028H to 03FH, 048H to 0FFH and 140H to 7FFH are physically not implemented. Reading these locations will usually result in FFH bytes. Attempts to write to these locations will be ignored. If the bus master sends a starting address higher than 7FFH, the five most significant address bits are set to 0s by the internal circuitry of the chip. This will result in a mismatch between the CRC calculated by the DS1985 and the CRC calculated by the bus master, indicating an error condition.

MEMORY FUNCTION COMMANDS

The “Memory Function Flow Chart” (Figure 5) describes the protocols necessary for accessing the various data fields within the DS1985. The Memory Function Control section, 8-bit scratchpad, and the Program Voltage Detect circuit combine to interpret the commands issued by the bus master and create the correct control signals within the device. A 3-byte protocol is issued by the bus master. It is comprised of a command byte to determine the type of operation and two address bytes to determine the specific starting byte location within a data field. The command byte indicates if the device is to be read or written. Writing data involves not only issuing the correct command sequence but also providing a 12V programming voltage at the appropriate times. To execute a write sequence, a byte of data is first loaded into the scratchpad and then programmed into the selected address. Write sequences always occur a byte at a time. To execute a read sequence, the starting address is issued by the bus master and data is read from the part beginning at that initial location and continuing to the end of the selected data field or until a reset sequence is issued. All bits transferred to the DS1985 and received back by the bus master are sent least significant bit first.

READ MEMORY [F0H]

The Read Memory command is used to read data from the 16384-bits EPROM data field. The bus master follows the command byte with a two byte address (TA1=(T7:T0), TA2=(T15:T8)) that indicates a starting byte location within the data field. With every subsequent read data time slot the bus master receives data from the DS1985 starting at the initial address and continuing until the end of the 16384-bits data field is reached or until a Reset Pulse is issued. If reading occurs through the end of memory space, the bus master may issue sixteen additional read time slots and the DS1985 will respond with a 16-bit CRC of the command, address bytes and all data bytes read from the initial starting byte through the last byte of memory. This CRC is the result of clearing the CRC generator and then shifting in the command byte followed by the two address bytes and the data bytes beginning at the first addressed memory location and continuing through to the last byte of the EPROM data memory. After the CRC is received by the bus master, any subsequent read time slots will appear as logical 1s until a Reset Pulse is issued. Any reads ended by a Reset Pulse prior to reaching the end of memory will not have the 16-bit CRC available.

Typically a 16-bit CRC would be stored with each page of data to ensure rapid, error-free data transfers that eliminate having to read a page multiple times to determine if the received data is correct or not. (See Book of DS19xx iButton Standards, Chapter 7 for the recommended file structure to be used with the 1-Wire environment.) If CRC values are imbedded within the data, a Reset Pulse may be issued at the end of memory space during a Read Memory command.

READ STATUS [AAH]

The Read Status command is used to read data from the EPROM Status data field. The bus master follows the command byte with a 2-byte address (TA1=(T7:T0), TA2=(T15:T8)) that indicates a starting byte location within the data field. With every subsequent read data time slot the bus master receives data from the DS1985 starting at the supplied address and continuing until the end of an 8-byte page of the EPROM Status data field is reached. At that point the bus master will receive a 16-bit CRC of the command byte, address bytes and status data bytes. This CRC is computed by the DS1985 and read back by the bus master to check if the command word, starting address and data were received correctly. If the CRC read by the bus master is incorrect, a Reset Pulse must be issued and the entire sequence must be repeated.

Note that the initial pass through the Read Status flow chart will generate a 16-bit CRC value that is the result of clearing the CRC generator and then shifting in the command byte followed by the two address bytes, and finally the data bytes beginning at the first addressed memory location and continuing through to the last byte of the addressed EPROM Status data page. The last byte of a Status data page always has an ending address of xx7 or xxFH. Subsequent passes through the Read Status flow chart will generate a 16-bit CRC that is the result of clearing the CRC generator and then shifting in the new data bytes starting at the first byte of the next page of the EPROM Status data field.

This feature is provided since the EPROM Status information may change over time making it impossible to program the data once and include an accompanying CRC that will always be valid. Therefore, the Read Status command supplies a 16-bit CRC that is based on and always is consistent with the current data stored in the EPROM Status data field.

After the 16-bit CRC of the last EPROM Status data page is read, the bus master will receive logical 1s from the DS1985 until a Reset Pulse is issued. The Read Status command sequence can be ended at any point by issuing a Reset Pulse.

MEMORY FUNCTION FLOW CHART Figure 5

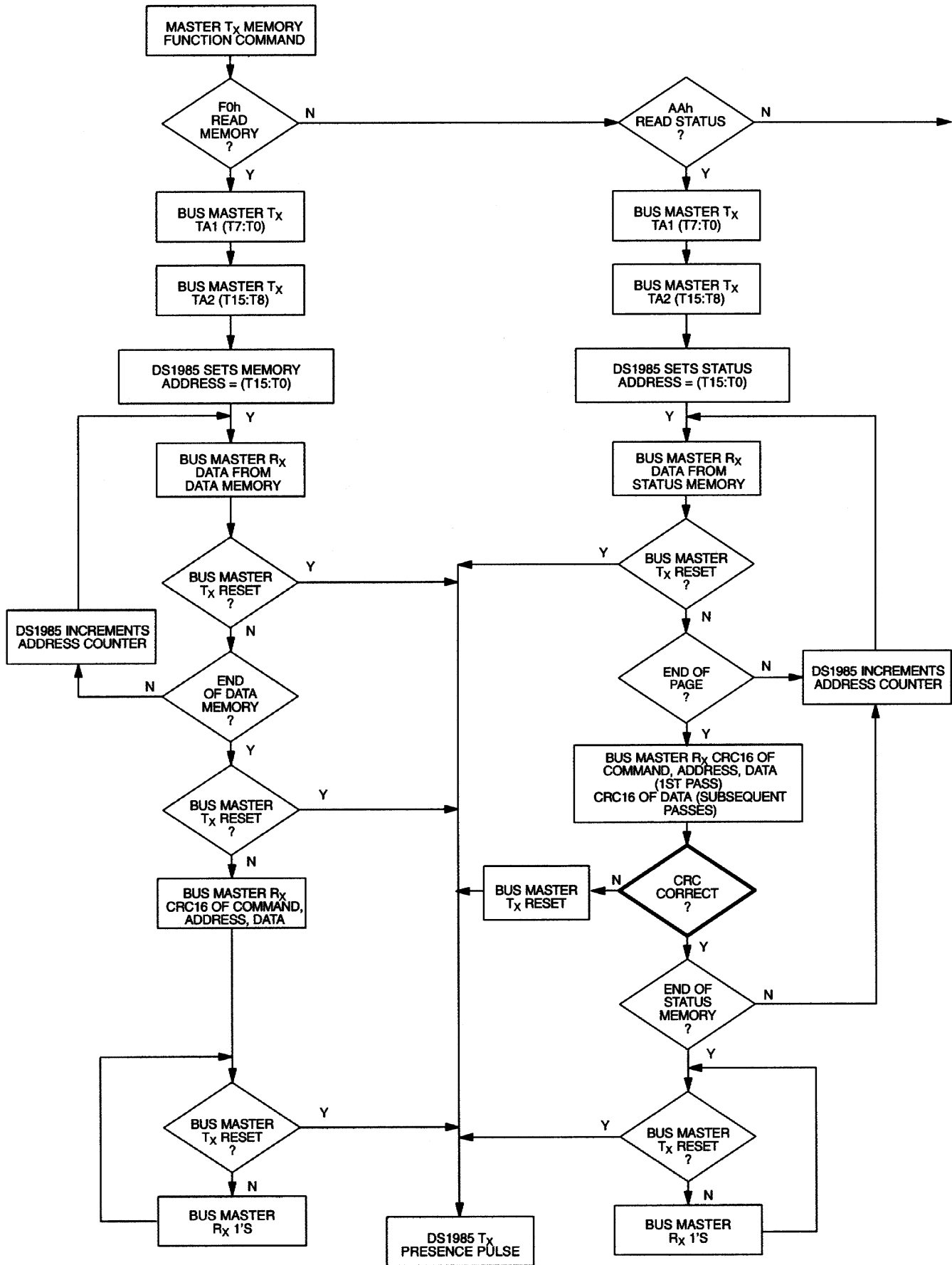

MEMORY FUNCTION FLOW CHART (cont'd) Figure 5

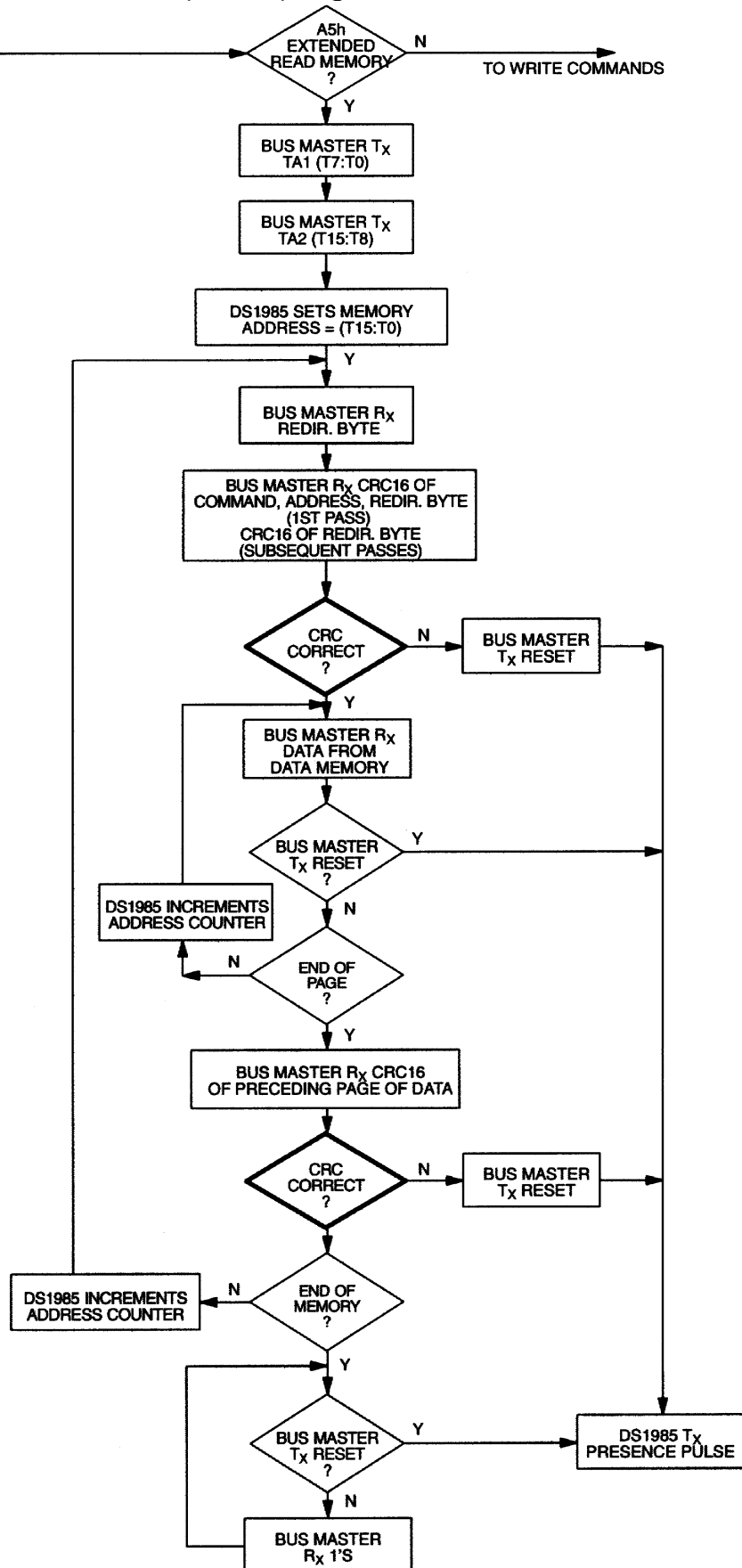
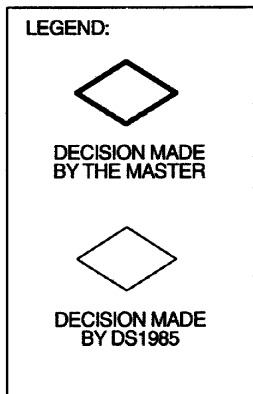

MEMORY FUNCTION FLOW CHART (cont'd) Figure 5

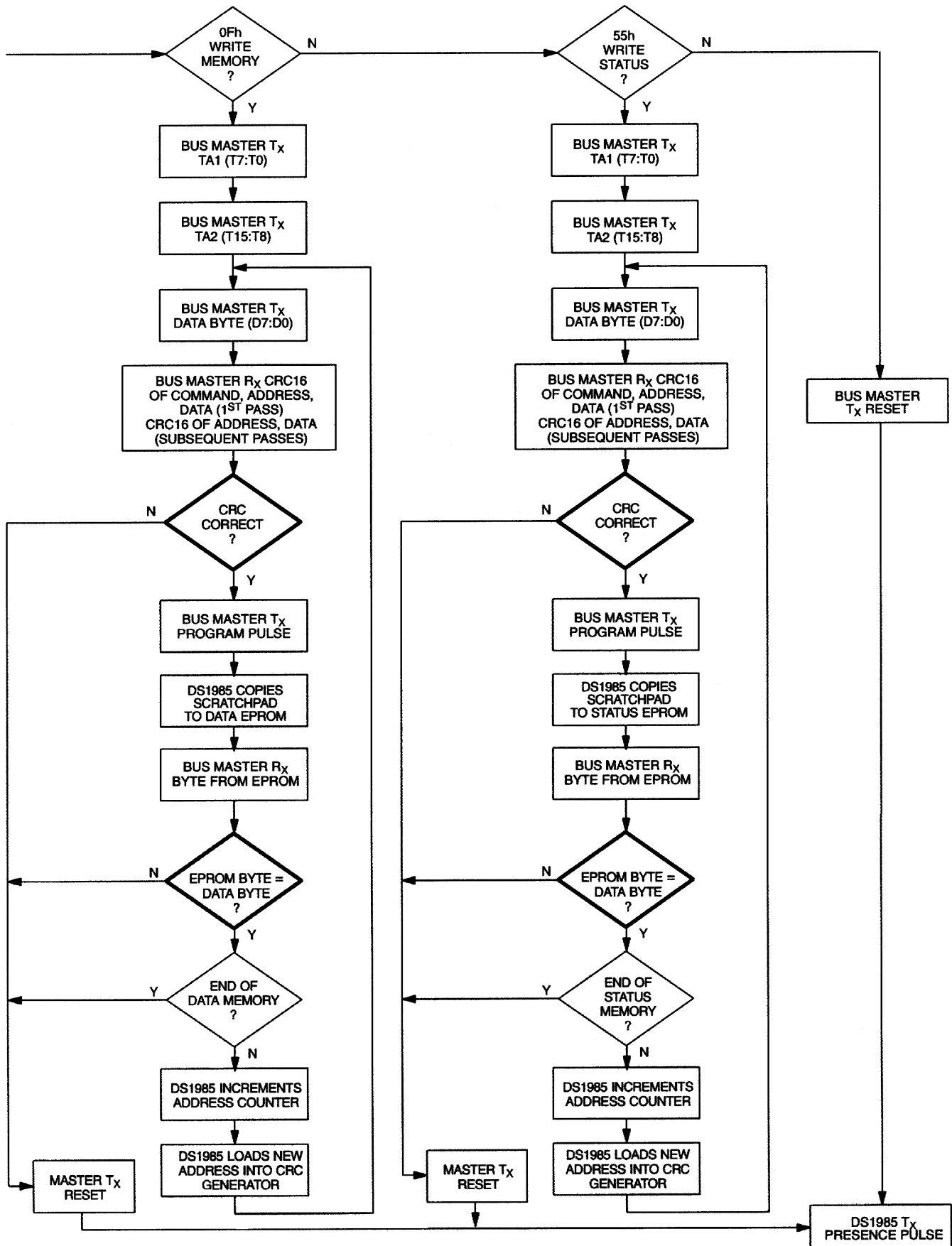

EXTENDED READ MEMORY [A5H]

The Extended Read Memory command supports page redirection when reading data from the 16384-bit EPROM data field. One major difference between the Extended Read Memory and the basic Read Memory command is that the bus master receives the Redirection Byte first before investing time in reading data from the addressed memory location. This allows the bus master to quickly decide whether to continue and access the data at the selected starting page or to terminate and restart the reading process at the redirected page address. A non-redirected page is identified by a Redirection Byte with a value of FFH (see description of EPROM Status Bytes). If the Redirection Byte is different than this, the master has to complement it to obtain the new page number. Multiplying the page number by 32 (20H) results in the new address the master has to send to the DS1985 to read the updated data replacing the old data. There is no logical limitation in the number of redirections of any page. The only limit is the number of available memory pages within the DS1985.

In addition to page redirection, the Extended Read Memory command also supports “bit-oriented” applications where the user cannot store a 16-bit CRC with the data itself. With bit-oriented applications the EPROM information may change over time within a page boundary making it impossible to include an accompanying CRC that will always be valid. Therefore, the Extended Read Memory command concludes each page with the DS1985 generating and supplying a 16-bit CRC that is based on and therefore always consistent with the current data stored in each page of the 16384-bit EPROM data field.

After having sent the command code of the Extended Read Memory command, the bus master follows the command byte with a 2-byte address (TA1=(T7:T0), TA2=(T15:T8)) that indicates a starting byte location within the data field. By sending eight read data time slots, the master receives the Redirection Byte associated with the page given by the starting address. With the next sixteen read data time slots, the bus master receives a 16-bit CRC of the command byte, address bytes and the Redirection Byte. This CRC is computed by the DS1985 and read back by the bus master to check if the command word, starting address and Redirection Byte were received correctly.

If the CRC read by the bus master is incorrect, a Reset Pulse must be issued and the entire sequence must be repeated. If the CRC received by the bus master is correct, the bus master issues read time slots and receives data from the DS1985 starting at the initial address and continuing until the end of a 32-byte page is reached. At that point the bus master will send 16 additional read time slots and receive a 16-bit CRC that is the result of shifting into the CRC generator all of the data bytes from the initial starting byte to the last byte of the current page.

With the next 24 read data time slots the master will receive the Redirection Byte of the next page followed by a 16-bit CRC of the Redirection Byte. After this, data is again read from the 16384-bit EPROM data field starting at the beginning of the new page. This sequence will continue until the final page and its accompanying CRC are read by the bus master.

The Extended Read Memory command provides a 16-bit CRC at two locations within the transaction flow chart: 1) after the Redirection Byte and 2) at the end of each memory page. The CRC at the end of the memory page is always the result of clearing the CRC generator and shifting in the data bytes beginning at the first addressed memory location of the EPROM data page until the last byte of this page. The CRC received by the bus master directly following the Redirection Byte, is calculated in two different ways. With the initial pass through the Extended Read Memory flow chart the 16-bit CRC value is the result of shifting the command byte into the cleared CRC generator, followed by the two address bytes and the Redirection Byte. Subsequent passes through the Extended Read Memory flow chart will generate a 16-bit CRC that is the result of clearing the CRC generator and then shifting in the Redirection Byte only.

WRITE MEMORY [0FH]

The Write Memory command is used to program the 16384-bit EPROM data field. The bus master will follow the command byte with a two byte starting address (TA1=(T7:T0), TA2=(T15:T8)) and a byte of data (D7:D0). A 16-bit CRC of the command byte, address bytes, and data byte is computed by the DS1985 and read back by the bus master to confirm that the correct command word, starting address, and data byte were received.

The highest starting address within the DS1985 is 07FFH. If the bus master sends a starting address higher than this, the five most significant address bits are set to 0 by the internal circuitry of the chip. This will result in a mismatch between the CRC calculated by the DS1985 and the CRC calculated by the bus master, indicating an error condition.

If the CRC read by the bus master is incorrect, a Reset Pulse must be issued and the entire sequence must be repeated. If the CRC received by the bus master is correct, a programming pulse (12 volts on the 1-Wire bus for 480 μ s) is issued by the bus master. Prior to programming, the entire unprogrammed 16384-bit EPROM data field will appear as logical 1s. For each bit in the data byte provided by the bus master that is set to a logical 0, the corresponding bit in the selected byte of the 16384-bit EPROM will be programmed to a logical 0 after the programming pulse has been applied at that byte location.

After the 480 μ s programming pulse is applied and the data line returns to the idle level, the bus master issues eight read time slots to verify that the appropriate bits have been programmed. The DS1985 responds with the data from the selected EPROM address sent least significant bit first. This byte contains the logical AND of all bytes written to this EPROM data address. If the EPROM data byte contains 1s in bit positions where the byte issued by the master contained 0s, a Reset Pulse should be issued and the current byte address should be programmed again. If the DS1985 EPROM data byte contains 0s in the same bit positions as the data byte, the programming was successful and the DS1985 will automatically increment its address counter to select the next byte in the 16384-bit EPROM data field. The new 2-byte address will also be loaded into the 16-bit CRC generator as a starting value. The bus master will issue the next byte of data using eight write time slots.

As the DS1985 receives this byte of data into the scratchpad, it also shifts the data into the CRC generator that has been preloaded with the current address and the result is a 16-bit CRC of the new data byte and the new address. After supplying the data byte, the bus master will read this 16-bit CRC from the DS1985 with 16 read time slots to confirm that the address incremented properly and the data byte was received correctly. If the CRC is incorrect, a Reset Pulse must be issued and the Write Memory command sequence must be restarted. If the CRC is correct, the bus master will issue a programming pulse and the selected byte in memory will be programmed.

Note that the initial pass through the Write Memory flow chart will generate a 16-bit CRC value that is the result of shifting the command byte into the CRC generator, followed by the two address bytes, and finally the data byte. Subsequent passes through the Write Memory flow chart due to the DS1985 automatically incrementing its address counter will generate a 16-bit CRC that is the result of loading (not shifting) the new (incremented) address into the CRC generator and then shifting in the new data byte.

For both of these cases, the decision to continue (to apply a Program Pulse to the DS1985) is made entirely by the bus master, since the DS1985 will not be able to determine if the 16-bit CRC calculated by the bus master agrees with the 16-bit CRC calculated by the DS1985. If an incorrect CRC is ignored and a Program Pulse is applied by the bus master, incorrect programming could occur within the DS1985. Also note that the DS1985 will always increment its internal address counter after the receipt of the eight read time slots used to confirm the programming of the selected EPROM byte. The decision to continue is again made entirely by the bus master, therefore if the EPROM data byte does not match the supplied data byte but the master continues with the Write Memory command, incorrect programming could occur within the DS1985. The Write Memory command sequence can be ended at any point by issuing a Reset Pulse.

To save time when writing more than one consecutive byte of the DS1985's data memory it is possible to omit reading the 16-bit CRC, which allows verification of data and address before the data is copied to the EPROM memory. This saves 16 time slots or 976 μ s for every byte to be programmed. This speed-programming mode is accessed with the command code F3H instead of 0FH. It follows basically the same flow chart as the Write Memory command, but skips sending the CRC immediately preceding the Program Pulse. This command should only be used if the electrical contact between bus master and the DS1985 is firm since a poor contact may result in corrupted data inside the EPROM memory.

WRITE STATUS [55H]

The Write Status command is used to program the EPROM Status data field. The bus master will follow the command byte with a 2-byte starting address (TA1=(T7:T0), TA2=(T15:T8)) and a byte of status data (D7:D0). A 16-bit CRC of the command byte, address bytes, and data byte is computed by the DS1985 and read back by the bus master to confirm that the correct command word, starting address, and data byte were received.

If the CRC read by the bus master is incorrect, a Reset Pulse must be issued and the entire sequence must be repeated. If the CRC received by the bus master is correct, a programming pulse (12 volts on the 1-Wire bus for 480 μ s) is issued by the bus master. Prior to programming, the EPROM Status data field will appear as logical 1s. For each bit in the data byte provided by the bus master that is set to a logical 0, the corresponding bit in the selected byte of the EPROM Status data field will be programmed to a logical 0 after the programming pulse has been applied at that byte location.

After the 480 μ s programming pulse is applied and the data line returns to the idle level, the bus master issues eight read time slots to verify that the appropriate bits have been programmed. The DS1985 responds with the data from the selected EPROM Status address sent least significant bit first. This byte contains the logical AND of all bytes written to this EPROM Status Byte address. If the EPROM Status Byte contains 1s in bit positions where the byte issued by the master contained 0s, a Reset Pulse should be issued and the current byte address should be programmed again. If the DS1985 EPROM Status byte contains 0s in the same bit positions as the data byte, the programming was successful and the DS1985 will automatically increment its address counter to select the next byte in the EPROM Status data field. The new two-byte address will also be loaded into the 16-bit CRC generator as a starting value. The bus master will issue the next byte of data using eight write time slots.

As the DS1985 receives this byte of data into the scratchpad, it also shifts the data into the CRC generator that has been preloaded with the current address, and the result is a 16-bit CRC of the new data byte and the new address. After supplying the data byte, the bus master will read this 16-bit CRC from the DS1985 with 16 read time slots to confirm that the address incremented properly and the data byte was received correctly. If the CRC is incorrect, a Reset Pulse must be issued and the Write Status command sequence must be restarted. If the CRC is correct, the bus master will issue a programming pulse and the selected byte in memory will be programmed.

Note that the initial pass through the Write Status flow chart will generate a 16-bit CRC value that is the result of shifting the command byte into the CRC generator, followed by the 2 address bytes, and finally the data byte. Subsequent passes through the Write Status flow chart due to the DS1985 automatically incrementing its address counter will generate a 16-bit CRC that is the result of loading (not shifting) the new (incremented) address into the CRC generator and then shifting in the new data byte.

For both of these cases, the decision to continue (to apply a Program Pulse to the DS1985) is made entirely by the bus master, since the DS1985 will not be able to determine if the 16-bit CRC calculated by the bus master agrees with the 16-bit CRC calculated by the DS1985. If an incorrect CRC is ignored and a Program Pulse is applied by the bus master, incorrect programming could occur within the DS1985. Also note that the DS1985 will always increment its internal address counter after the receipt of the eight read time slots used to confirm the programming of the selected EPROM byte. The decision to continue is again made entirely by the bus master, therefore if the EPROM data byte does not match the supplied data byte but the master continues with the Write Status command, incorrect programming could occur within the DS1985. The Write Status command sequence can be ended at any point by issuing a Reset Pulse.

To save time when writing more than one consecutive byte of the DS1985s status memory it is possible to omit reading the 16-bit CRC which allows verification of data and address before the data is copied to the EPROM memory. This saves 16 time slots or 976 μ s for every byte to be programmed. This speed-programming mode is accessed with the command code F5H instead of 55H. It follows basically the same flow chart as the Write Status command, but skips sending the CRC immediately preceding the Program Pulse. This command should only be used if the electrical contact between bus master and the DS1985 is firm since a poor contact may result in corrupted data inside the EPROM status memory.

1-WIRE BUS SYSTEM

The 1-Wire bus is a system which has a single bus master and one or more slaves. In all instances, the DS1985 is a slave device. The bus master is typically a microcontroller. The discussion of this bus system is broken down into three topics: hardware configuration, transaction sequence, and 1-Wire signaling (signal type and timing). A 1-Wire protocol defines bus transactions in terms of the bus state during specified time slots that are initiated on the falling edge of sync pulses from the bus master. For a more detailed protocol description, refer to Chapter 4 of the Book of DS19xx μ Button Standards.

Hardware Configuration

The 1-Wire bus has only a single line by definition; it is important that each device on the bus be able to drive it at the appropriate time. To facilitate this, each device attached to the 1-Wire bus must have an open drain connection or 3-state outputs. The DS1985 is an open drain part with an internal circuit equivalent to that shown in Figure 6. The bus master can be the same equivalent circuit. If a bidirectional pin is not available, separate output and input pins can be tied together.

The bus master requires a pullup resistor at the master end of the bus, with the bus master circuit equivalent to the one shown in Figures 7a and 7b. The value of the pullup resistor should be approximately 5 k Ω for short line lengths.

A multidrop bus consists of a 1-Wire bus with multiple slaves attached. The 1-Wire bus has a maximum data rate of 16.3 kbits per second. If the bus master is also required to perform programming of the EPROM portions of the DS1985, a programming supply capable of delivering up to 10 milliamps at 12 volts for 480 μ s is required. The idle state for the 1-Wire bus is high. If, for any reason, a transaction needs to be suspended, the bus **MUST** be left in the idle state if the transaction is to resume. If this does not occur and the bus is left low for more than 120 μ s, one or more of the devices on the bus may be reset.

Transaction Sequence

The sequence for accessing the DS1985 via the 1-Wire port is as follows:

- Initialization
- ROM Function Command
- Memory Function Command
- Read/Write Memory/Status

INITIALIZATION

All transactions on the 1-Wire bus begin with an initialization sequence. The initialization sequence consists of a Reset Pulse transmitted by the bus master followed by a Presence Pulse(s) transmitted by the slave(s).

The Presence Pulse lets the bus master know that the DS1985 is on the bus and is ready to operate. For more details, see the “1-Wire Signaling” section.

ROM FUNCTION COMMANDS

Once the bus master has detected a presence, it can issue one of the four ROM function commands. All ROM function commands are 8 bits long. A list of these commands follows (refer to flowchart in Figure 8):

Read ROM [33H]

This command allows the bus master to read the DS1985’s 8-bit family code, unique 48-bit serial number, and 8-bit CRC. This command can be used only if there is a single DS1985 on the bus. If more than one slave is present on the bus, a data collision will occur when all slaves try to transmit at the same time (open drain will produce a wired-AND result).

DS1985 EQUIVALENT CIRCUIT Figure 6

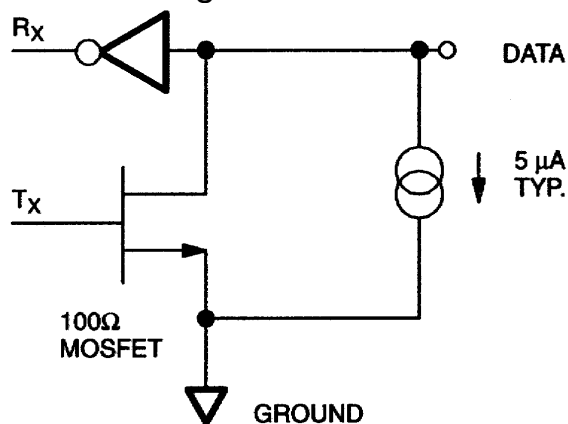

BUS MASTER CIRCUIT Figure 7

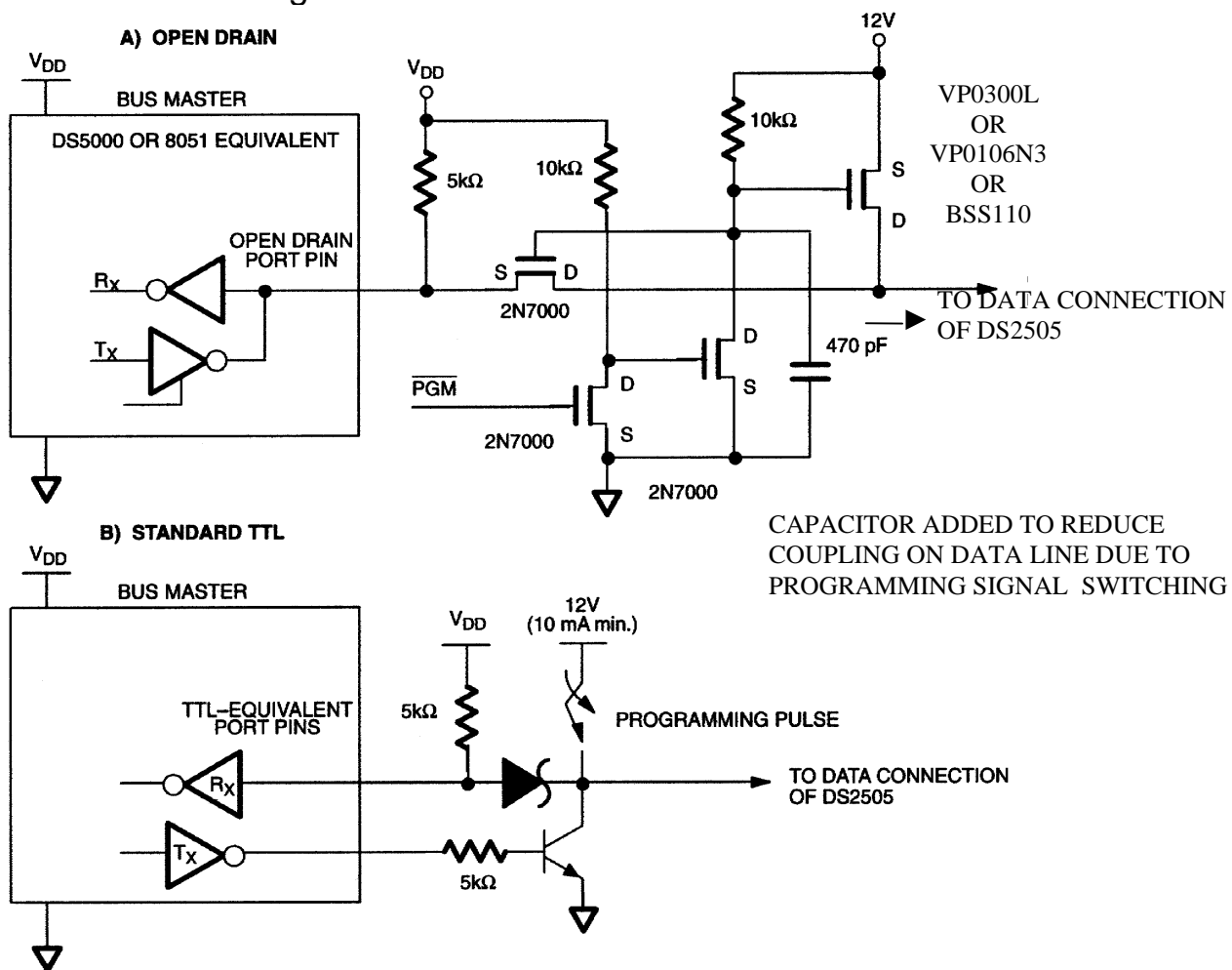

ROM FUNCTIONS FLOW CHART Figure 8

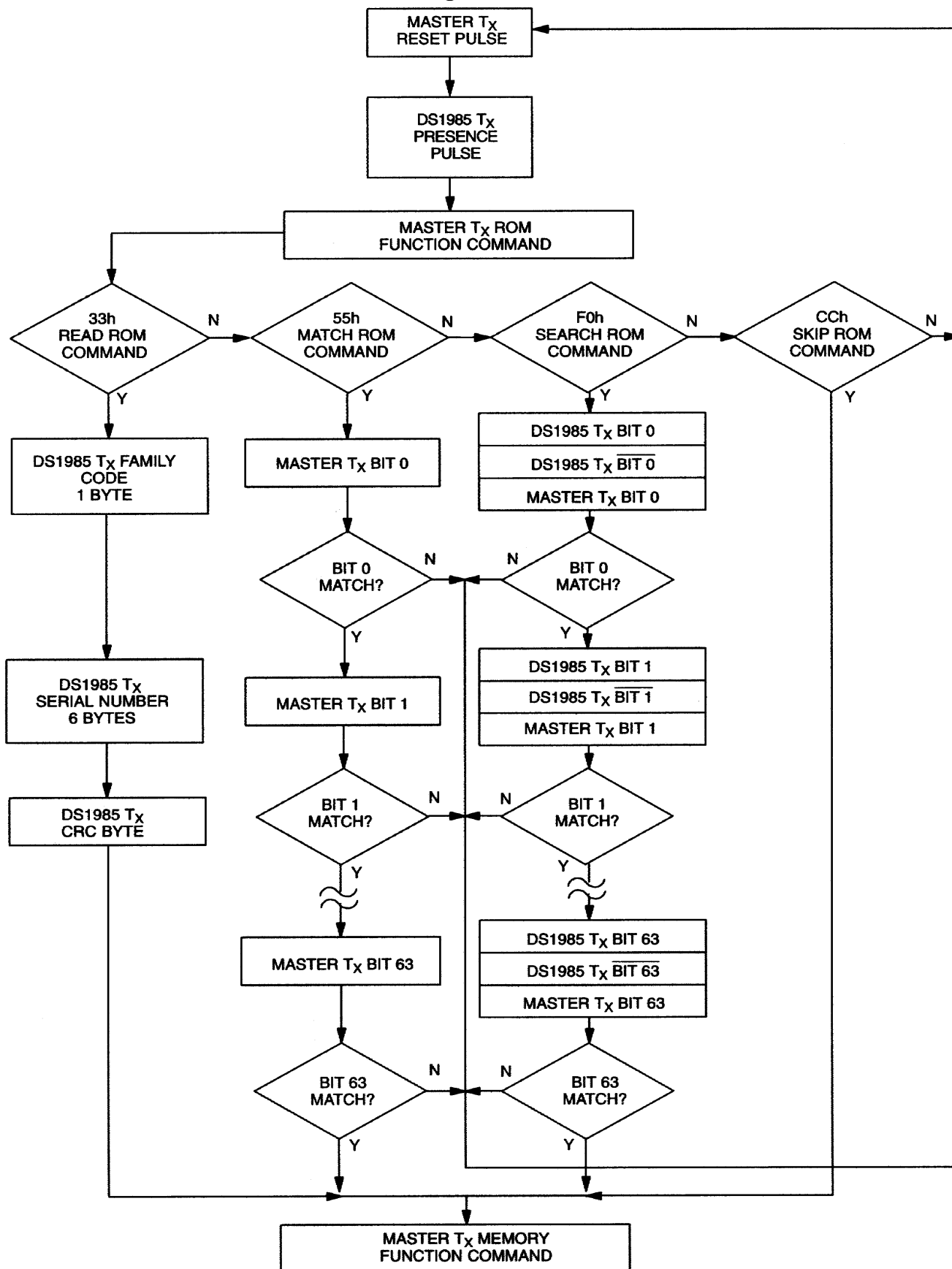

(See Figure 5)

Match ROM [55H]

The Match ROM command, followed by a 64-bit ROM sequence, allows the bus master to address a specific DS1985 on a multidrop bus. Only the DS1985 that exactly matches the 64-bit ROM sequence will respond to the subsequent memory function command. All slaves that do not match the 64-bit ROM sequence will wait for a Reset Pulse. This command can be used with a single or multiple devices on the bus.

Skip ROM [CCH]

This command can save time in a single drop bus system by allowing the bus master to access the memory functions without providing the 64-bit ROM code. If more than one slave is present on the bus and a read command is issued following the Skip ROM command, data collision will occur on the bus as multiple slaves transmit simultaneously (open drain pulldowns will produce a wired-AND result).

Search ROM [F0H]

When a system is initially brought up, the bus master might not know the number of devices on the 1-Wire bus or their 64-bit ROM codes. The Search ROM command allows the bus master to use a process of elimination to identify the 64-bit ROM codes of all slave devices on the bus. The ROM search process is the repetition of a simple three-step routine: read a bit, read the complement of the bit, then write the desired value of that bit. The bus master performs this simple, three-step routine on each bit of the ROM. After one complete pass, the bus master knows the contents of the ROM in one device. The remaining number of devices and their ROM codes may be identified by additional passes. See Chapter 5 of the Book of DS19xx iButton Standards for a comprehensive discussion of a ROM search, including an actual example.

1-Wire Signaling

The DS1985 requires strict protocols to ensure data integrity. The protocol consists of five types of signaling on one line: Reset Sequence with Reset Pulse and Presence Pulse, Write 0, Write 1, Read Data and Program Pulse. All these signals except Presence Pulse are initiated by the bus master. The initialization sequence required to begin any communication with the DS1985 is shown in Figure 9. A Reset Pulse followed by a Presence Pulse indicates the DS1985 is ready to accept a ROM command. The bus master transmits (TX) a Reset Pulse (t_{RSTL} , minimum 480 μ s). The bus master then releases the line and goes into receive mode (RX). The 1-Wire bus is pulled to a high state via the pullup resistor. After detecting the rising edge on the data pin, the DS1985 waits (t_{PDH} , 15-60 μ s) and then transmits the Presence Pulse (t_{PDL} , 60-240 μ s).

Read/Write Time Slots

The definitions of write and read time slots are illustrated in Figure 10. All time slots are initiated by the master driving the data line low. The falling edge of the data line synchronizes the DS1985 to the master by triggering a delay circuit in the DS1985. During write time slots, the delay circuit determines when the DS1985 will sample the data line. For a read data time slot, if a “0” is to be transmitted, the delay circuit determines how long the DS1985 will hold the data line low overriding the 1 generated by the master. If the data bit is a “1”, the iButton will leave the read data time slot unchanged.

PROGRAM PULSE

To copy data from the 8-bit scratchpad to the EPROM Data or Status Memory, a Program Pulse of 12 volts is applied to the data line after the bus master has confirmed that the CRC for the current byte is correct. During programming, the bus master controls the transition from a state where the data line is idling high via the pullup resistor to a state where the data line is actively driven to a programming voltage of 12 volts providing a minimum of 10 mA of current to the DS1985. This programming voltage

(Figure 11) should be applied for 480 μ s, after which the bus master returns the data line to an idle high state controlled by the pullup resistor. Note that due to the high voltage programming requirements for any 1-Wire EPROM device, it is not possible to multidrop non-EPROM based 1-Wire devices with the DS1985 during programming. An internal diode within the non-EPROM based 1-Wire devices will attempt to clamp the data line at approximately 8 volts and could potentially damage these devices.

INITIALIZATION PROCEDURE “RESET AND PRESENCE PULSES” Figure 9

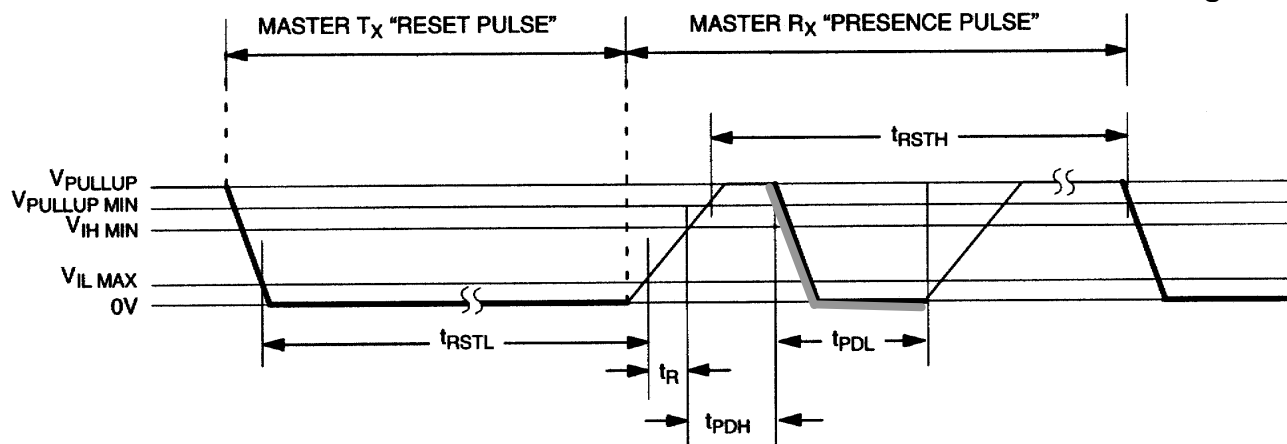

	RESISTOR
	MASTER
	DS1985

- $480 \mu\text{s} \leq t_{RSTL} < \infty *$
- $480 \mu\text{s} \leq t_{RSTH} < \infty$ (includes recovery time)
- $15 \mu\text{s} \leq t_{PDH} < 60 \mu\text{s}$
- $60 \mu\text{s} \leq t_{PDL} < 240 \mu\text{s}$

* In order not to mask interrupt signaling by other devices on the 1-Wire bus, $t_{RSTL} + t_R$ should always be less than 960 μ s.

READ/WRITE TIMING DIAGRAM Figure 10

Write-1 Time Slot

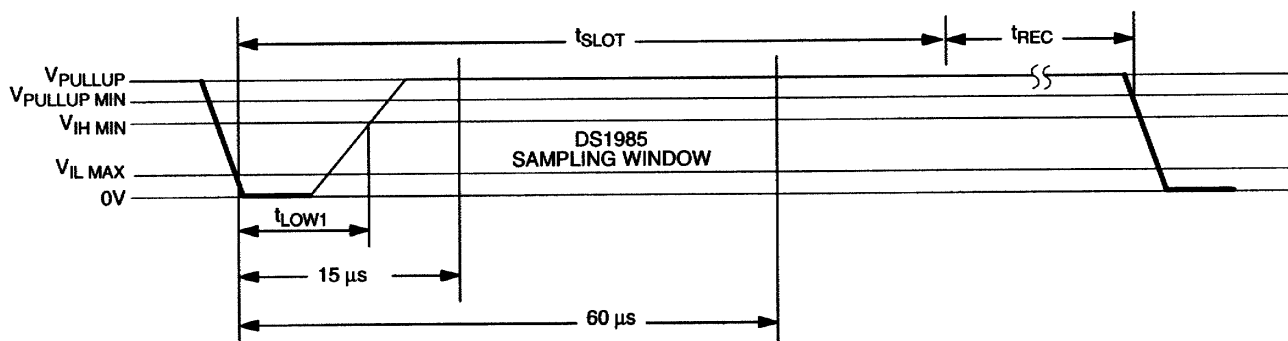

	RESISTOR
	MASTER

- $60 \mu\text{s} \leq t_{SLOT} < 120 \mu\text{s}$
- $1 \mu\text{s} \leq t_{LOW1} < 15 \mu\text{s}$
- $1 \mu\text{s} \leq t_{REC} < \infty$

READ/WRITE TIMING DIAGRAM (cont'd) Figure 10

Write-0 Time Slot

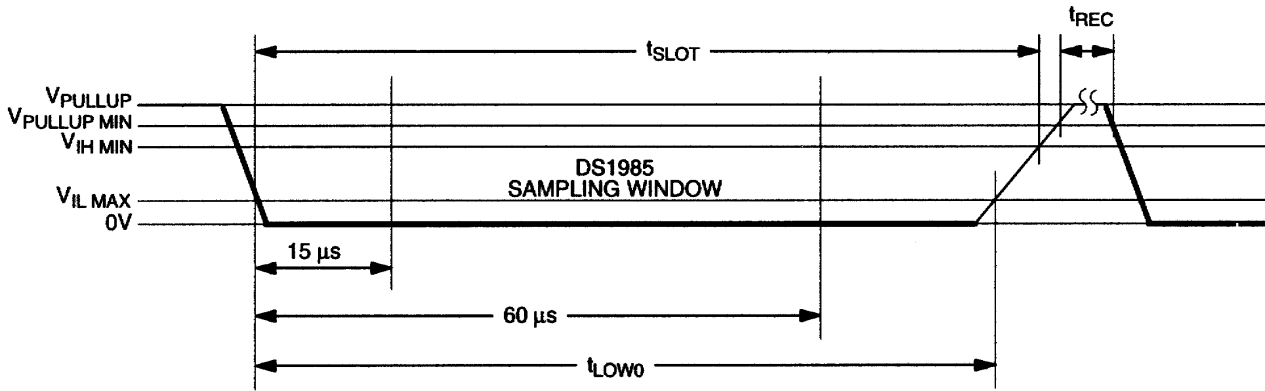

$$60 \mu s \leq t_{LOW0} < t_{SLOT} < 120 \mu s$$

$$1 \mu s \leq t_{REC} < \infty$$

Read-Data Time Slot

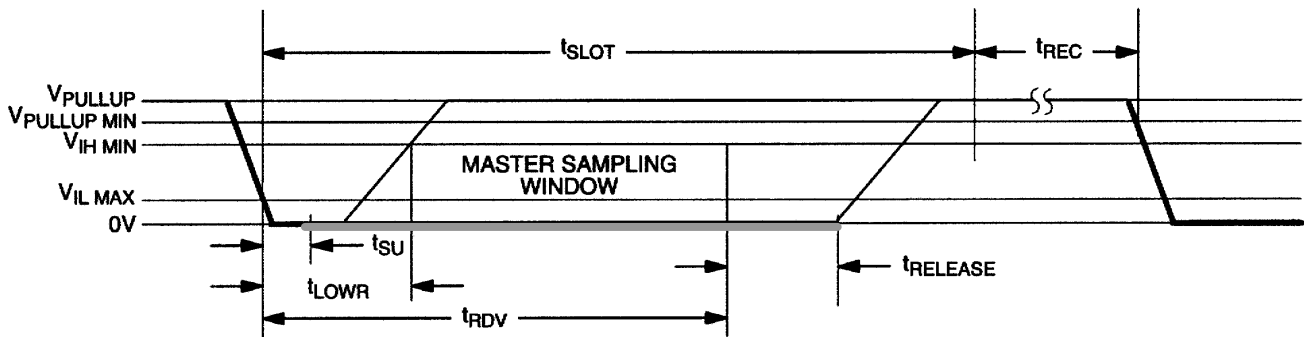

	RESISTOR
	MASTER
	DS1985

$$60 \mu s \leq t_{SLOT} < 120 \mu s$$

$$1 \mu s \leq t_{LOWR} < 15 \mu s$$

$$0 \leq t_{RELEASE} < 45 \mu s$$

$$1 \mu s \leq t_{REC} < \infty$$

$$t_{RDV} = 15 \mu s$$

$$t_{SU} < 1 \mu s$$

PROGRAM PULSE TIMING DIAGRAM Figure 11

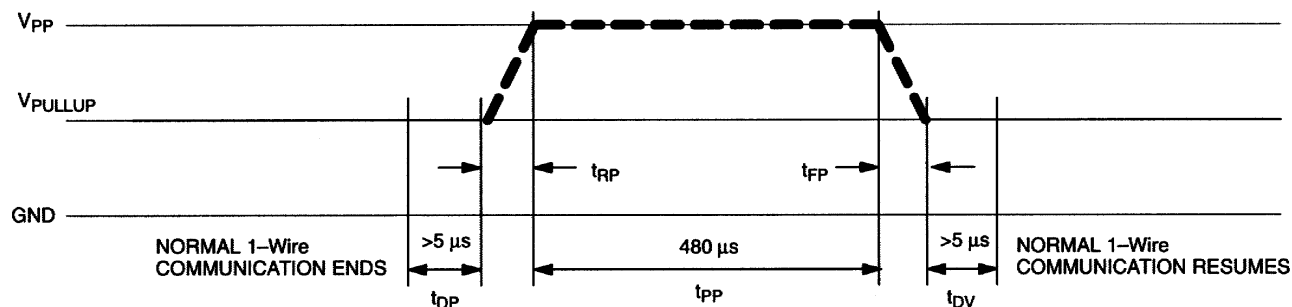

LINE TYPE LEGEND:

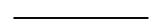
	Bus master active high (12V @ 10 mA)
	Resistor pullup

CRC GENERATION

With the DS1985 there are two different types of CRCs (Cyclic Redundancy Checks). One CRC is an 8-bit type and is stored in the most significant byte of the 64-bit ROM. The bus master can compute a CRC value from the first 56 bits of the 64-bit ROM and compare it to the value stored within the DS1985 to determine if the ROM data has been received error-free by the bus master. The equivalent polynomial function of this CRC is: $X^8 + X^5 + X^4 + 1$. This 8-bit CRC is received in the true (non-inverted) form when reading the ROM of the DS1985. It is computed once at the factory and lasered into the ROM.

The other CRC is a 16-bit type, generated according to the standardized CRC16-polynomial function $X^{16} + X^{15} + X^2 + 1$. This CRC is used to safeguard user-defined EPROM data when reading data memory or status memory. It is the same type of CRC as is used with NV RAM based *i*Buttons to safeguard data packets of the *i*Button File Structure. In contrast to the 8-bit CRC, the 16-bit CRC is always returned in the complemented (inverted) form. A CRC-generator inside the DS1985 chip (Figure 12) will calculate a new 16-bit CRC at every situation shown in the command flow chart of Figure 5.

The DS1985 provides this CRC-value to the bus master to validate the transfer of command, address, and data to and from the bus master. When reading the data memory of the DS1985 with the Read Memory command, the 16-bit CRC is only transmitted as the end of the memory is reached. This CRC is generated by clearing the CRC generator, shifting in the command, low address, high address and every data byte starting at the first addressed memory location and continuing until the end of the implemented data memory is reached.

When reading the status memory with the Read Status command, the 16-bit CRC is transmitted when the end of each 8-byte page of the status memory is reached. At the initial pass through the Read Status flow chart the 16-bit CRC will be generated by clearing the CRC generator, shifting in the command byte, low address, high address and the data bytes beginning at the first addressed memory location and continuing until the last byte of the addressed EPROM Status data page is reached. Subsequent passes through the Read Status flow chart will generate a 16-bit CRC that is the result of clearing the CRC generator and then shifting in the new data bytes starting at the first byte of the next page of the EPROM Status data field and continuing until the last byte of the page is reached.

When reading the data memory of the DS1985 with the Extended Read Memory command, there are two situations where a 16-bit CRC is transmitted. One 16-bit CRC follows each Redirection Byte, another 16-bit CRC is received after the last byte of a memory data page is read. The CRC at the end of the memory page is always the result of clearing the CRC generator and shifting in the data bytes beginning at the first addressed memory location of the EPROM data page until the last byte of this page. With the initial pass through the Extended Read Memory flow chart the 16-bit CRC value is the result of shifting the command byte into the cleared CRC generator, followed by the 2 address bytes and the Redirection Byte. Subsequent passes through the Extended Read Memory flow chart will generate a 16-bit CRC that is the result of clearing the CRC generator and then shifting in the Redirection Byte only.

When writing to the DS1985 (either data memory or status memory), the bus master receives a 16-bit CRC to verify the correctness of the data transfer before applying the programming pulse. With the initial pass through the Write Memory/Status flow chart the 16-bit CRC will be generated by clearing the CRC generator, shifting in the command, address low, address high and the data byte. Subsequent passes through the Write Memory/Status flow chart due to the DS1985 automatically incrementing its address counter will generate an 16-bit CRC that is the result of loading (not shifting) the new (incremented) address into the CRC generator and then shifting in the new data byte.

The comparison of CRC values and decision to continue with an operation are determined entirely by the bus master. There is no circuitry on the DS1985 that prevents a command sequence from proceeding if the CRC stored in or calculated by the DS1985 does not match the value generated by the bus master. For more details on generating CRC values including example implementations in both hardware and software, see the Book of DS19xx iButton Standards.

CRC-16 HARDWARE DESCRIPTION AND POLYNOMIAL Figure 12

$$\text{POLYNOMIAL} = X^{16} + X^{15} + X^2 + 1$$

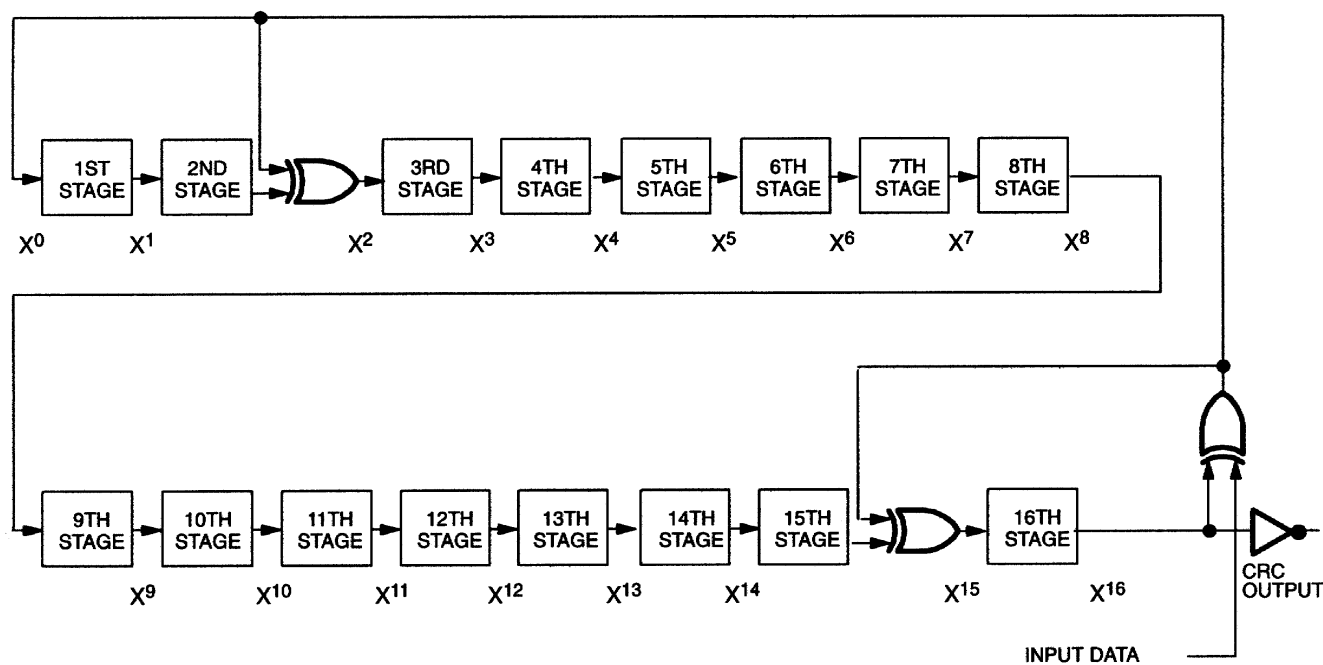

ABSOLUTE MAXIMUM RATINGS*

Voltage on any Pin Relative to Ground	-0.5V to +12.0V
Operating Temperature	-40°C to +85°C
Storage Temperature	-55°C to +125°C

* This is a stress rating only and functional operation of the device at these or any other conditions outside those indicated in the operation sections of this specification is not implied. Exposure to absolute maximum rating conditions for extended periods of time may affect reliability.

DC ELECTRICAL CHARACTERISTICS ($V_{PUP} = 2.8V$ to $6.0V$; $-40^{\circ}C$ to $+85^{\circ}C$)

PARAMETER	SYMBOL	MIN	TYP	MAX	UNITS	NOTES
Logic 1	V_{IH}	2.2			V	1,6
Logic 0	V_{IL}	-0.3		+0.8	V	1,10
Output Logic Low @ 4 mA	V_{OL}			0.4	V	1
Output Logic High	V_{OH}		V_{PUP}	6.0	V	1,2
Input Load Current	I_L		5		μA	3
Operating Charge	Q_{OP}			30	nC	7,8
Programming Voltage @ 10 mA	V_{PP}	11.5		12.0	V	

CAPACITANCE ($t_A = 25^{\circ}C$)

PARAMETER	SYMBOL	MIN	TYP	MAX	UNITS	NOTES
Data (1-Wire)	$C_{IN/OUT}$			800	pF	9

AC ELECTRICAL CHARACTERISTICS ($V_{PUP} = 2.8V$ to $6.0V$; $-40^{\circ}C$ to $+85^{\circ}C$)

PARAMETER	SYMBOL	MIN	TYP	MAX	UNITS	NOTES
Time Slot	t_{SLOT}	60		120	μs	
Write-1 Low Time	t_{LOW1}	1		15	μs	
Write-0 Low Time	t_{LOW0}	60		120	μs	
Read Data Valid	t_{RDV}	exactly 15			μs	
Release Time	$t_{RELEASE}$	0	15	45	μs	
Read Data Setup	t_{SU}			1	μs	5
Recovery Time	t_{REC}	1			μs	
Reset Time High	t_{RSTH}	480			μs	4
Reset Time Low	t_{RSTL}	480			μs	
Presence Detect High	t_{PDHIGH}	15		60	μs	
Presence Detect Low	t_{PDLow}	60		240	μs	
Delay to Program	t_{DP}	5			μs	
Delay to Verify	t_{DV}	5			μs	
Program Pulse Width	t_{PP}	480			μs	
Program Voltage Rise Time	t_{RP}	0.5		5.0	μs	
Program Voltage Fall Time	t_{FP}	0.5		5.0	μs	

NOTES:

1. All voltages are referenced to ground.
2. V_{PUP} = external pullup voltage. If V_{PUP} is lower than 3.0V the first byte read (any read command) may not reproduce the correct memory contents. Therefore, under low voltage conditions, it is recommended to set either the most significant bit or all five most significant bits of TA2 to 1. Internal circuitry of the chip will force these five bits back to 0 **before** they are shifted in the address counter and CRC generator.
3. Input load is to ground.
4. An additional reset or communication sequence cannot begin until the reset high time has expired.
5. Read data setup time refers to the time the host must pull the 1-Wire bus low to read a bit. Data is guaranteed to be valid within 1 μ s of this falling edge and will remain valid for 14 μ s minimum. (15 μ s total from falling edge on 1-Wire bus.)
6. V_{IH} is a function of the external pullup resistor and V_{PUP} .
7. 30 nanocoulombs per 72 time slots @ 5.0V.
8. At V_{CC} =5.0V with a 5k Ω pullup to V_{CC} and a maximum time slot of 120 μ s.
9. Capacitance on the data pin could be 800 pF when power is first applied. If a 5k Ω resistor is used to pull up the data line to V_{CC} , 5 μ s after power has been applied the parasite capacitance will not affect normal communications.
10. Under certain low voltage conditions V_{ILMAX} may have to be reduced to as much as 0.5V to always guarantee a presence pulse.