

NPN SILICON HIGH FREQUENCY TRANSISTOR

FEATURES

- **HIGH GAIN BANDWIDTH:** $f_T = 25$ GHz
- **LOW NOISE FIGURE:** $NF = 1.1$ dB at 2 GHz
- **HIGH MAXIMUM STABLE GAIN:** 20 dB at $f = 2$ GHz
- **NEW LOW PROFILE M04 PACKAGE:**
 - SOT-343 footprint, with a height of just 0.59 mm
 - Flat Lead Style for better RF performance

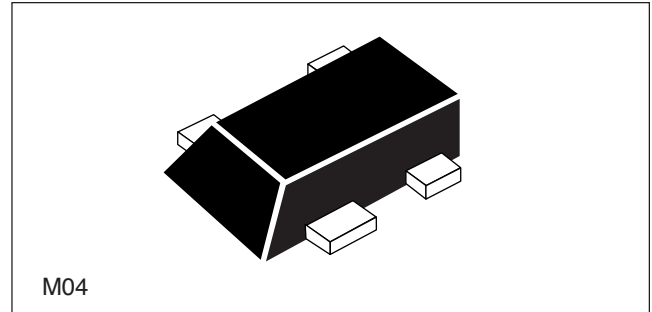

DESCRIPTION

NEC's NE662M04 is fabricated using NEC's UHS0 25 GHz f_T wafer process. With a typical transition frequency of 25 GHz the NE662M04 is usable in applications from 100 MHz to 10 GHz. The NE662M04 provides excellent low voltage/low current performance.

NEC's new low profile/flat lead style "M04" package is ideal for today's portable wireless applications. The NE662M04 is an ideal choice for LNA and oscillator requirements in all mobile communication systems.

ELECTRICAL CHARACTERISTICS ($T_A = 25^\circ\text{C}$)

PART NUMBER EIAJ ¹ REGISTERED NUMBER PACKAGE OUTLINE		NE662M04 2SC5508 M04				
SYMBOLS	PARAMETERS AND CONDITIONS	UNITS	MIN	TYP	MAX	
DC	I_{CBO}	Collector Cutoff Current at $V_{CB} = 5\text{V}$, $I_E = 0$	nA		200	
	I_{EBO}	Emitter Cutoff Current at $V_{EB} = 1\text{V}$, $I_C = 0$	nA		200	
	h_{FE}	Forward Current Gain ² at $V_{CE} = 2\text{V}$, $I_C = 5\text{mA}$		50	70	100
RF	f_T	Gain Bandwidth at $V_{CE} = 3\text{V}$, $I_C = 30\text{mA}$, $f = 2\text{GHz}$	GHz	20	25	
	MAG	Maximum Available Power Gain ⁴ at $V_{CE} = 2\text{V}$, $I_C = 20\text{mA}$, $f = 2\text{GHz}$	dB		20	
	MSG	Maximum Stable Gain ⁵ at $V_{CE} = 2\text{V}$, $I_C = 20\text{mA}$, $f = 2\text{GHz}$	dB		20	
	$ S_{21E} ^2$	Insertion Power Gain at $V_{CE} = 2\text{V}$, $I_C = 20\text{mA}$, $f = 2\text{GHz}$	dB	14	17	
	NF	Noise Figure at $V_{CE} = 2\text{V}$, $I_C = 5\text{mA}$, $f = 2\text{GHz}$, $Z_{IN} = Z_{OPT}$	dB		1.1	1.5
	P_{1dB}	Output Power at 1 dB compression point at $V_{CE} = 2\text{V}$, $I_C = 20\text{mA}$, $f = 2\text{GHz}$	dBm		11	
	IP_3	Third Order Intercept Point at $V_{CE} = 2\text{V}$, $I_C = 20\text{mA}$, $f = 2\text{GHz}$			22	
C_{re}	Feedback Capacitance ³ at $V_{CB} = 2\text{V}$, $I_C = 0$, $f = 1\text{MHz}$	pF		0.18	0.24	

Notes:

1. Electronic Industrial Association of Japan.
2. Pulsed measurement, pulse width $\leq 350\ \mu\text{s}$, duty cycle $\leq 2\%$.
3. Capacitance is measured by capacitance meter (automatic balance bridge method) when emitter pin is connected to the guard pin.

$$4. \text{MAG} = \left| \frac{S_{21}}{S_{12}} \right| \left(K - \sqrt{K^2 - 1} \right)$$

$$5. \text{MSG} = \left| \frac{S_{21}}{S_{12}} \right|$$

The information in this document is subject to change without notice. Before using this document, please confirm that this is the latest version.

ABSOLUTE MAXIMUM RATINGS¹ (T_A = 25°C)

SYMBOLS	PARAMETERS	UNITS	RATINGS
V _{CB0}	Collector to Base Voltage	V	15
V _{CE0}	Collector to Emitter Voltage	V	3.3
V _{EB0}	Emitter to Base Voltage	V	1.5
I _C	Collector Current	mA	35
P _T	Total Power Dissipation	mW	115
T _J	Junction Temperature	°C	150
T _{STG}	Storage Temperature	°C	-65 to +150

Note:

1. Operation in excess of any one of these parameters may result in permanent damage.

TYPICAL OPTIMAL NOISE MATCHING (T_A = 25°C)

V_{CE} = 2 V, I_C = 5 mA, f = 1 GHz

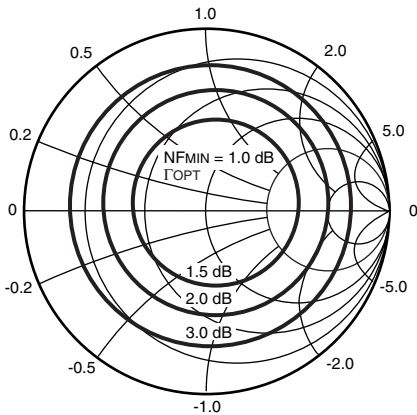

V_{CE} = 2 V, I_C = 5 mA, f = 2 GHz

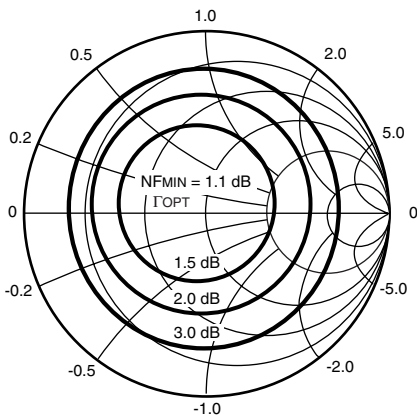

TYPICAL NOISE PARAMETERS (T_A = 25°C)

FREQ. (GHz)	NF _{MIN} (dB)	G _A (dB)	Γ _{OPT}		Rn/50
			MAG	ANG	
V _C = 2 V, I _C = 3 mA					
0.8	0.78	21.4	0.26	31.7	0.17
0.9	0.80	20.7	0.26	32.7	0.17
1.0	0.82	20.0	0.26	34.7	0.17
1.5	0.93	17.0	0.23	57.0	0.16
1.8	1.00	15.6	0.20	78.0	0.14
1.9	1.02	15.2	0.19	86.0	0.14
2.0	1.04	14.8	0.19	94.2	0.13
2.5	1.15	13.5	0.20	138.3	0.10
V _C = 2 V, I _C = 5 mA					
0.8	0.93	22.5	0.12	28.1	0.15
0.9	0.94	21.8	0.12	28.8	0.15
1.0	0.96	21.1	0.12	31.7	0.15
1.5	1.03	18.1	0.09	71.1	0.14
1.8	1.07	18.7	0.08	106.2	0.13
1.9	1.09	16.3	0.08	118.5	0.13
2.0	1.10	15.9	0.08	130.5	0.12
2.5	1.17	14.3	0.14	-179.7	0.11
V _C = 2 V, I _C = 10 mA					
0.8	1.28	23.7	0.07	-159.4	0.13
0.9	1.29	23.0	0.07	-157.5	0.13
1.0	1.30	22.3	0.08	-155.7	0.13
1.5	1.37	19.3	0.13	-149.2	0.13
1.8	1.41	17.8	0.18	-146.1	0.13
1.9	1.43	17.3	0.17	-146.0	0.13
2.0	1.44	16.9	0.19	-143.9	0.13
2.5	1.51	15.3	0.25	-136.7	0.13
V _C = 2 V, I _C = 20 mA					
0.8	1.59	24.5	0.28	-158.1	0.12
0.9	1.61	23.7	0.28	-155.5	0.13
1.0	1.63	23.0	0.27	-153.1	0.13
1.5	1.72	19.9	0.30	-142.6	0.14
1.8	1.78	18.3	0.33	-137.3	0.15
1.9	1.79	17.9	0.34	-135.7	0.08
2.0	1.81	17.5	0.35	-134.1	0.16
2.5	1.90	15.8	0.40	-126.5	0.18

THERMAL RESISTANCE

ITEM	SYMBOL	VALUE	UNIT
Junction to Case Resistance	R _{th j-c}	150	°C/W
Junction to Ambient Resistance	R _{th j-a}	650	°C/W

TYPICAL PERFORMANCE CURVES (TA = 25°C)

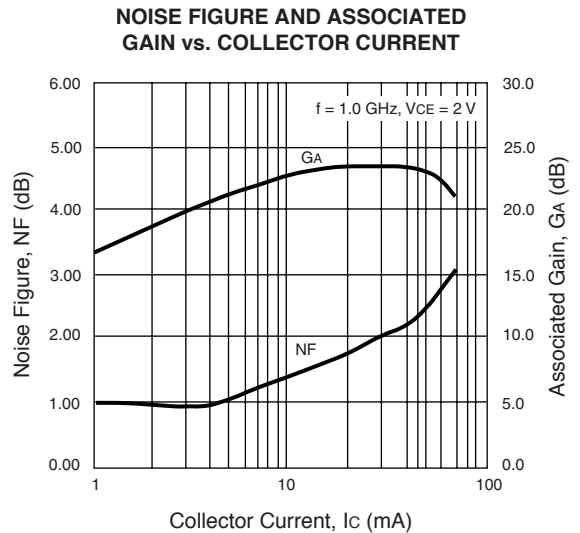
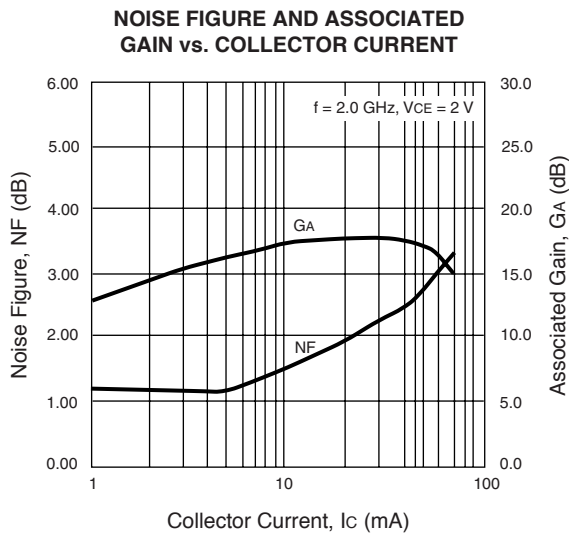
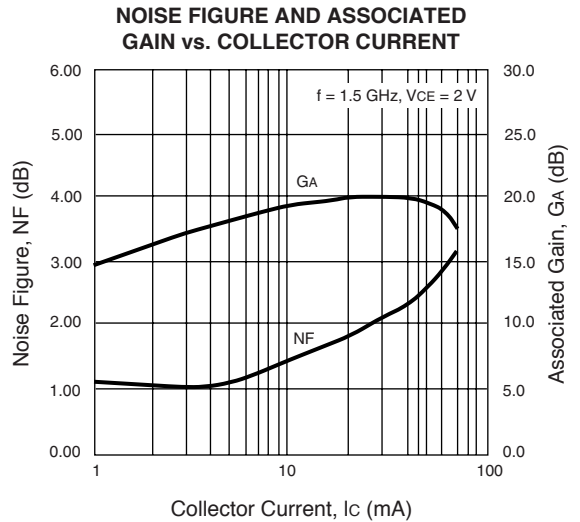
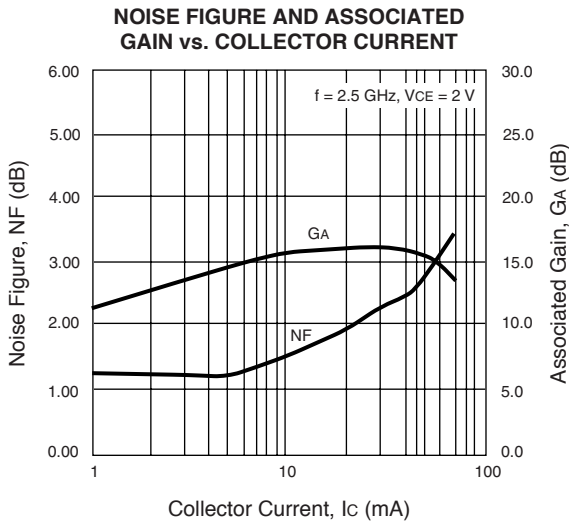
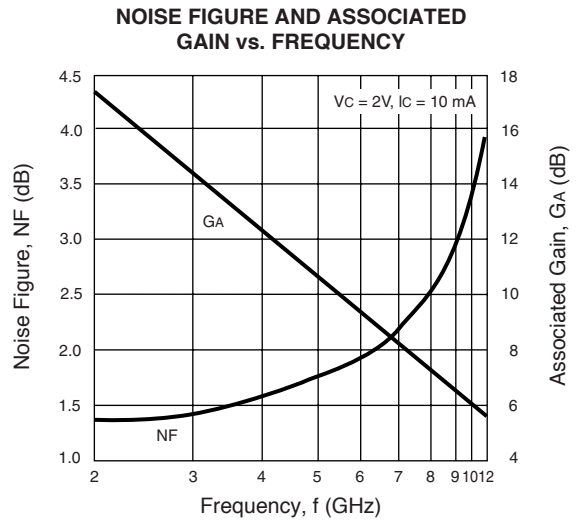
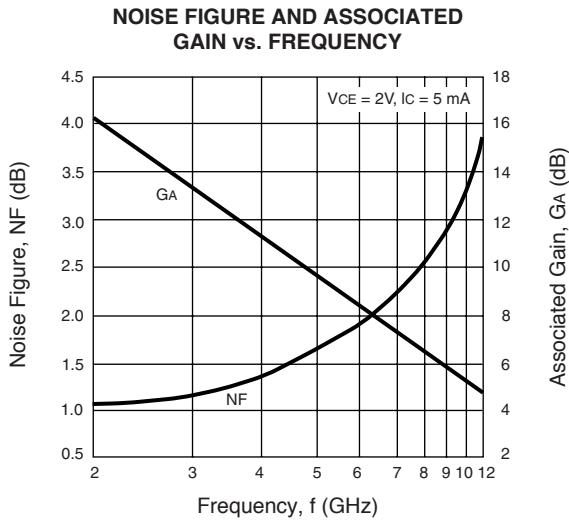

TYPICAL PERFORMANCE CURVES (T_A = 25°C)

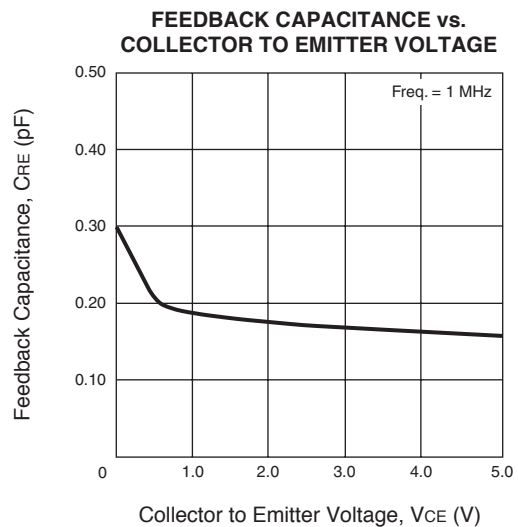
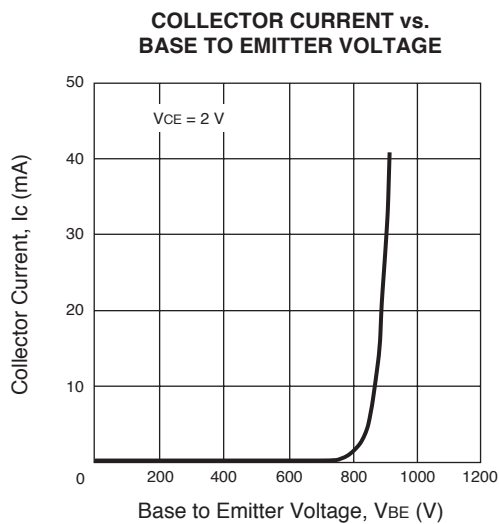
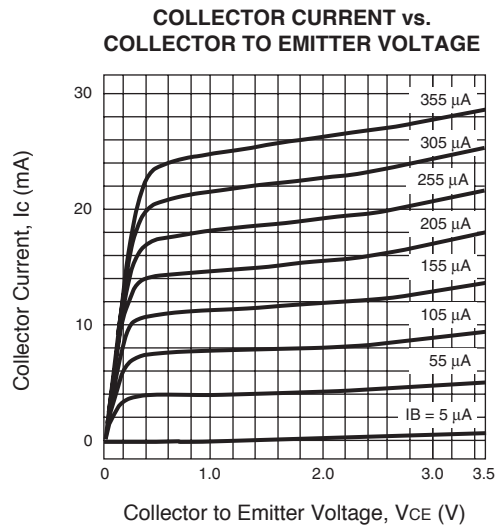
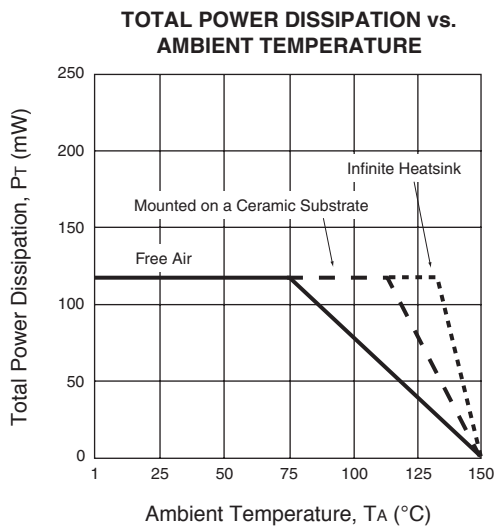
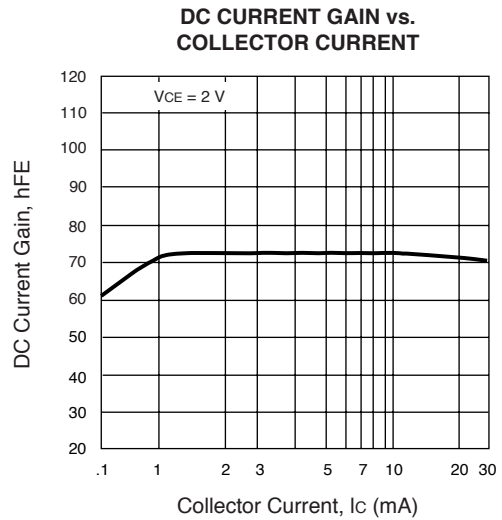
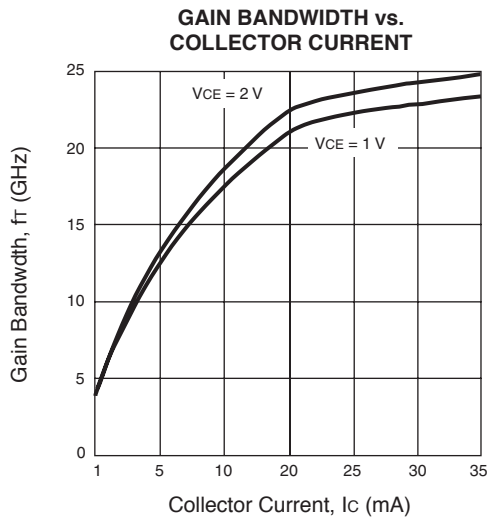

TYPICAL PERFORMANCE CURVES ($T_A = 25^\circ\text{C}$)

FORWARD INSERTION GAIN vs. FREQUENCY

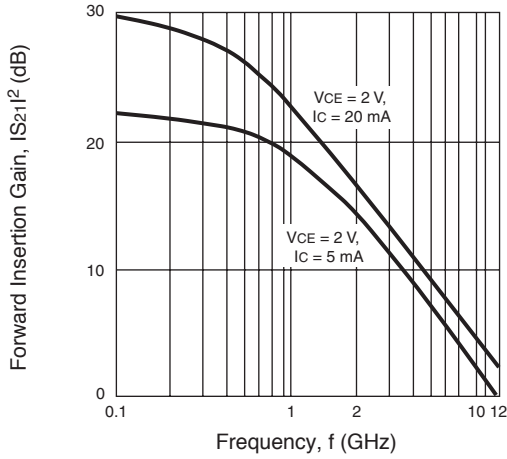

FORWARD INSERTION GAIN AND MAXIMUM AVAILABLE GAIN vs. FREQUENCY

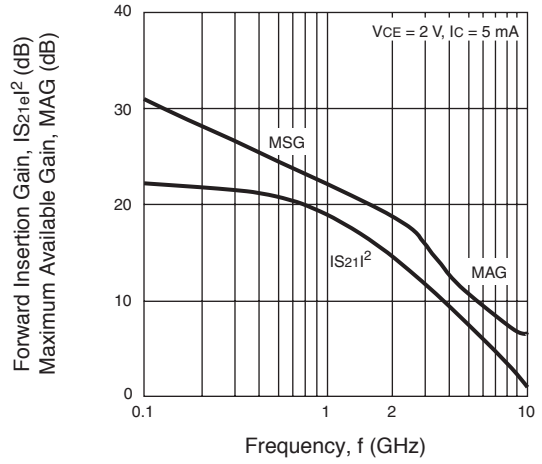

FORWARD INSERTION GAIN AND MAXIMUM AVAILABLE GAIN vs. FREQUENCY

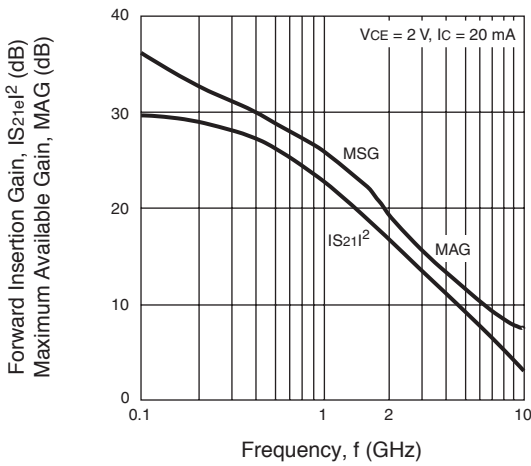

MAXIMUM STABLE GAIN, INSERTION POWER GAIN, MAXIMUM AVAILABLE GAIN vs. COLLECTOR CURRENT

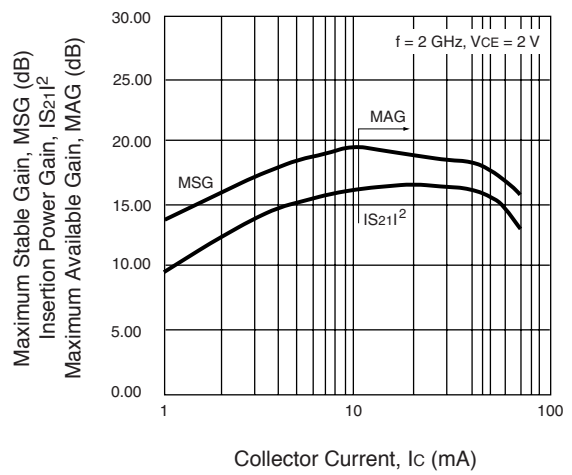

MAXIMUM STABLE GAIN, INSERTION POWER GAIN, MAXIMUM AVAILABLE GAIN vs. COLLECTOR CURRENT

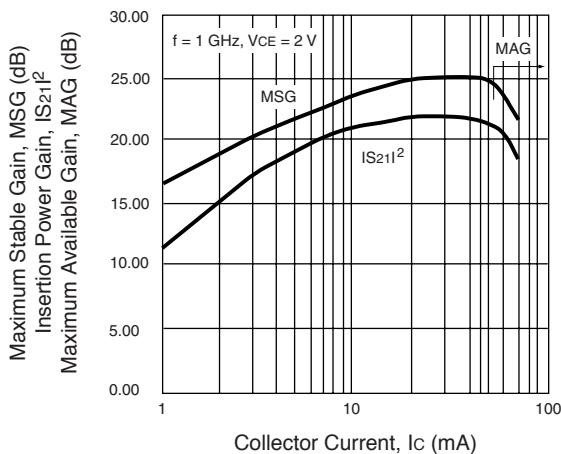

OUTLINE DIMENSIONS (Units in mm)

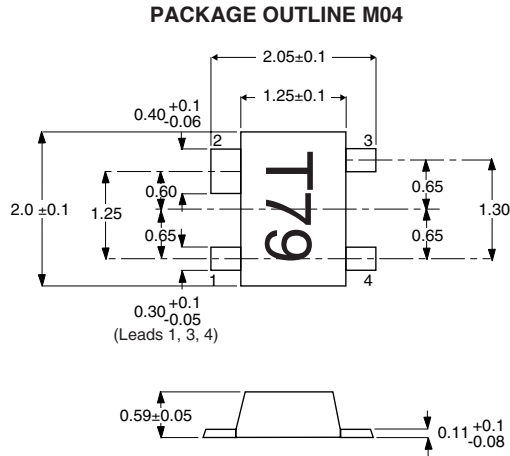

PIN CONNECTIONS

- 1. Emitter
- 2. Collector
- 3. Emitter
- 4. Base

ORDERING INFORMATION (Solder Contains Lead)

PART NUMBER	QUANTITY	PACKAGING
NE662M04-T2	3000	Tape & Reel

ORDERING INFORMATION (Pb-Free)

PART NUMBER	QUANTITY	PACKAGING
NE662M04-T2-A	3000	Tape & Reel

TYPICAL SCATTERING PARAMETERS (TA = 25°C)

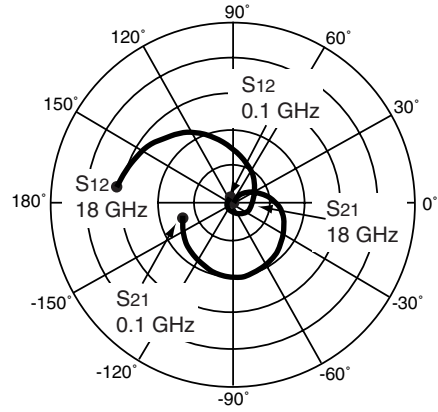
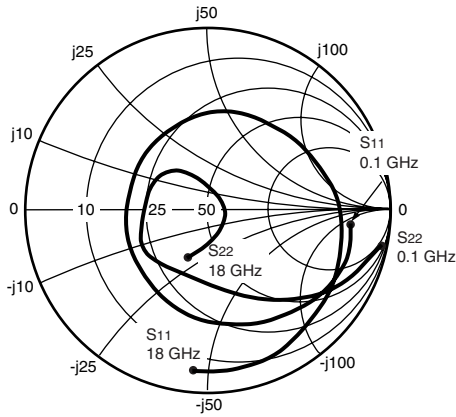

NE662M04

Vds = 2 V, Ids = 5 mA

FREQUENCY GHz	S11		S21		S12		S22		K	MAG ¹ (dB)
	MAG	ANG	MAG	ANG	MAG	ANG	MAG	ANG		
0.10	0.800	-6.49	12.912	170.08	0.010	80.54	0.975	-12.55	0.14	31.03
0.20	0.823	-20.59	12.309	162.54	0.019	73.16	0.908	-19.04	0.17	28.23
0.30	0.784	-33.50	11.948	153.92	0.026	66.89	0.878	-24.33	0.19	26.63
0.40	0.756	-44.64	11.513	146.61	0.033	61.60	0.844	-29.71	0.21	25.48
0.50	0.723	-54.00	11.004	139.33	0.038	56.80	0.798	-35.10	0.26	24.61
0.70	0.673	-71.29	9.884	126.94	0.047	49.31	0.717	-43.61	0.34	23.25
1.00	0.606	-94.50	8.378	111.49	0.056	40.70	0.626	-53.73	0.45	21.77
1.50	0.525	-125.16	6.529	91.42	0.065	32.29	0.529	-65.53	0.63	20.02
2.00	0.481	-149.81	5.267	75.35	0.071	27.18	0.473	-74.56	0.79	18.68
2.50	0.452	-171.81	4.390	61.34	0.077	23.73	0.437	-82.64	0.94	17.56
3.00	0.443	168.25	3.750	48.61	0.083	20.64	0.414	-90.48	1.05	15.25
3.50	0.447	149.84	3.263	36.68	0.088	17.74	0.399	-98.44	1.13	13.46
4.00	0.462	133.60	2.881	25.36	0.095	14.65	0.390	-106.85	1.18	12.25
5.00	0.503	106.93	2.323	3.99	0.108	7.35	0.391	-124.19	1.21	10.54
6.00	0.533	85.28	1.941	-15.75	0.122	-0.60	0.407	-138.63	1.21	9.27
7.00	0.561	64.59	1.663	-34.58	0.136	-10.18	0.414	-150.24	1.19	8.24
8.00	0.597	44.11	1.458	-53.07	0.151	-20.97	0.396	-161.21	1.17	7.35
9.00	0.648	25.70	1.289	-71.41	0.164	-32.58	0.365	-175.83	1.13	6.76
10.00	0.701	10.10	1.150	-89.34	0.176	-44.85	0.338	165.91	1.06	6.64
11.00	0.742	-3.57	1.033	-107.27	0.186	-57.61	0.322	147.34	0.99	7.44
12.00	0.770	-17.38	0.937	-125.45	0.195	-71.16	0.291	132.02	0.96	6.81
13.00	0.800	-32.18	0.852	-144.57	0.202	-86.33	0.220	115.42	0.96	6.26
14.00	0.832	-47.17	0.761	-164.70	0.199	-101.97	0.130	84.64	1.01	5.15
15.00	0.864	-60.22	0.669	174.87	0.191	-117.93	0.095	15.41	1.06	3.91
16.00	0.886	-71.89	0.586	154.00	0.179	-134.03	0.128	-38.31	1.13	2.94
17.00	0.893	-83.62	0.505	131.56	0.161	-150.31	0.183	-80.23	1.37	1.32
18.00	0.893	-95.92	0.432	109.00	0.142	-165.37	0.273	-113.09	1.78	-0.29

Note:

1. Gain Calculations:

$$MAG = \frac{|S_{21}|}{|S_{12}|} \left(K \pm \sqrt{K^2 - 1} \right). \text{ When } K \leq 1, \text{ MAG is undefined and MSG values are used. } MSG = \frac{|S_{21}|}{|S_{12}|}, K = \frac{1 + |\Delta|^2 - |S_{11}|^2 - |S_{22}|^2}{2 |S_{12} S_{21}|}, \Delta = S_{11} S_{22} - S_{21} S_{12}$$

MAG = Maximum Available Gain

MSG = Maximum Stable Gain

TYPICAL SCATTERING PARAMETERS (TA = 25°C)

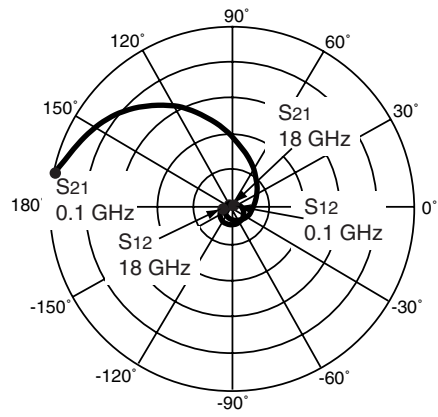
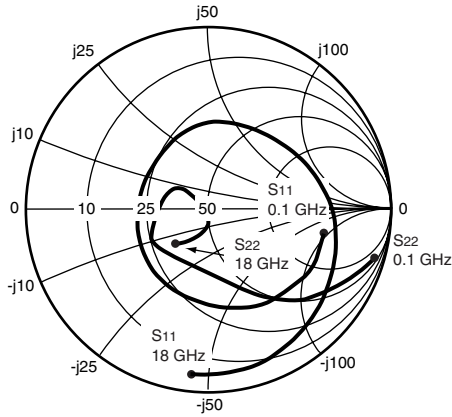

NE662M04

Vds = 2 V, Ids = 10 mA

FREQUENCY	S11		S21		S12		S22		K	MAG ¹
GHz	MAG	ANG	MAG	ANG	MAG	ANG	MAG	ANG		(dB)
0.10	0.656	-12.55	21.524	167.65	0.009	79.73	0.953	-15.38	0.17	33.8
0.50	0.558	-72.63	16.388	130.46	0.032	54.65	0.704	-43.47	0.39	27.1
1.00	0.459	-117.32	11.085	102.71	0.045	44.24	0.505	-61.57	0.64	23.9
1.50	0.411	-147.32	8.116	84.49	0.055	40.54	0.416	-71.56	0.83	21.7
2.00	0.390	-170.12	6.357	70.11	0.064	37.88	0.371	-79.33	0.95	19.9
2.50	0.380	169.60	5.209	57.41	0.074	34.88	0.345	-86.61	1.04	17.2
3.00	0.384	151.78	4.404	45.78	0.084	31.26	0.329	-94.15	1.10	15.3
3.50	0.396	135.61	3.812	34.81	0.093	27.22	0.318	-102.20	1.13	13.9
4.00	0.417	121.45	3.357	24.31	0.103	22.52	0.313	-110.82	1.14	12.8
4.50	0.441	109.14	2.999	14.09	0.112	17.49	0.312	-119.93	1.15	11.9
5.00	0.462	98.03	2.707	4.16	0.121	12.11	0.316	-128.31	1.14	11.2
5.50	0.478	88.13	2.466	-5.47	0.129	6.79	0.323	-135.75	1.14	10.5
6.00	0.489	78.58	2.270	-14.88	0.138	1.28	0.331	-141.92	1.14	9.9
6.50	0.502	69.13	2.100	-24.15	0.145	-4.55	0.338	-147.40	1.13	9.4
7.00	0.516	59.69	1.958	-33.35	0.153	-10.53	0.336	-152.31	1.12	8.9
7.50	0.533	50.19	1.835	-42.50	0.160	-16.66	0.329	-157.13	1.12	8.5
8.00	0.552	40.84	1.724	-51.68	0.166	-22.97	0.314	-161.77	1.12	8.1
8.50	0.578	32.06	1.624	-60.85	0.172	-29.26	0.298	-167.85	1.11	7.8
9.00	0.606	23.80	1.533	-70.03	0.177	-35.77	0.279	-175.31	1.09	7.5
9.50	0.635	16.08	1.448	-79.10	0.182	-42.17	0.262	-176.18	1.07	7.4
10.00	0.662	9.25	1.373	-88.08	0.186	-48.81	0.249	-167.10	1.04	7.4
10.50	0.687	2.66	1.303	-97.24	0.190	-55.36	0.238	-157.82	1.02	7.5
11.00	0.708	-3.68	1.240	-106.32	0.193	-62.02	0.228	-150.01	0.99	8.1
11.50	0.725	-10.23	1.180	-115.51	0.196	-68.84	0.216	-143.52	0.98	7.8
12.00	0.740	-16.97	1.129	-124.94	0.198	-75.82	0.196	-139.24	0.97	7.6
12.50	0.759	-23.90	1.078	-134.43	0.200	-82.99	0.165	-136.32	0.96	7.3
13.00	0.778	-31.43	1.026	-144.36	0.200	-90.81	0.130	-133.05	0.96	7.1
13.50	0.797	-39.26	0.971	-154.44	0.197	-98.62	0.089	-132.98	0.97	6.9
14.00	0.817	-46.37	0.917	-164.53	0.193	-105.96	0.043	-134.60	0.99	6.8
14.50	0.836	-53.18	0.862	-174.70	0.189	-113.50	0.008	-126.17	1.00	6.2
15.00	0.854	-59.55	0.809	-175.14	0.184	-121.17	0.045	-78.36	1.02	5.5
15.50	0.870	-65.38	0.760	-164.91	0.178	-128.62	0.074	-82.90	1.03	5.3
16.00	0.879	-71.31	0.714	-154.41	0.171	-136.43	0.100	-92.08	1.07	4.6
16.50	0.883	-77.25	0.668	-143.35	0.163	-144.44	0.126	-102.52	1.16	3.7
17.00	0.888	-83.09	0.622	-132.27	0.153	-152.15	0.161	-113.78	1.27	3.0
17.50	0.891	-89.24	0.576	-121.03	0.143	-159.23	0.204	-124.99	1.43	2.2
18.00	0.890	-95.45	0.539	-110.25	0.134	-166.19	0.250	-133.10	1.60	1.5

Note:

1. Gain Calculations:

$$MAG = \frac{|S_{21}|}{|S_{12}|} (K \pm \sqrt{K^2 - 1})$$

When $K \leq 1$, MAG is undefined and MSG values are used. $MSG = \frac{|S_{21}|}{|S_{12}|}$, $K = \frac{1 + |\Delta|^2 - |S_{11}|^2 - |S_{22}|^2}{2 |S_{12} S_{21}|}$, $\Delta = S_{11} S_{22} - S_{21} S_{12}$

MAG = Maximum Available Gain

MSG = Maximum Stable Gain

TYPICAL SCATTERING PARAMETERS (TA = 25°C)

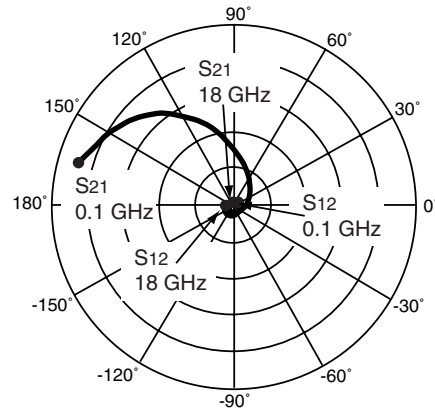
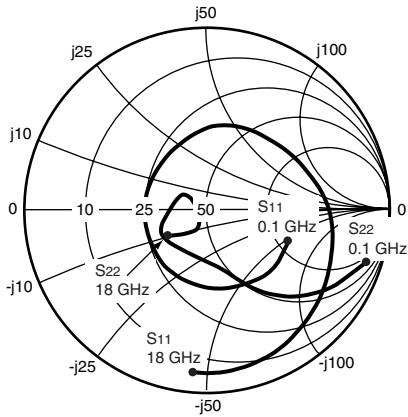

NE662M04

Vds = 2 V, Ids = 20 mA

FREQUENCY	S11		S21		S12		S22		K	MAG ¹
GHz	MAG	ANG	MAG	ANG	MAG	ANG	MAG	ANG		(dB)
0.10	0.478	-21.17	30.628	164.59	0.008	77.90	0.920	-18.24	0.27	35.8
0.50	0.420	-95.65	20.411	122.80	0.027	55.26	0.608	-50.41	0.54	28.8
1.00	0.377	-140.33	12.654	96.57	0.039	50.55	0.413	-66.91	0.81	25.1
1.50	0.361	-167.18	8.963	79.99	0.051	48.74	0.338	-75.34	0.96	22.5
2.00	0.356	173.00	6.924	66.76	0.063	45.98	0.304	-82.29	1.03	19.4
2.50	0.356	155.15	5.625	54.91	0.075	42.06	0.287	-89.18	1.08	17.1
3.00	0.366	139.53	4.733	43.94	0.087	37.36	0.276	-96.76	1.10	15.4
3.50	0.383	125.38	4.086	33.53	0.098	32.17	0.268	-105.14	1.12	14.1
4.00	0.405	112.90	3.595	23.51	0.109	26.52	0.265	-114.14	1.12	13.1
4.50	0.429	101.89	3.211	13.68	0.120	20.61	0.266	-123.63	1.12	12.2
5.00	0.449	91.80	2.900	4.06	0.129	14.46	0.271	-132.09	1.11	11.5
5.50	0.464	82.65	2.645	-5.30	0.138	8.45	0.278	-139.34	1.11	10.8
6.00	0.474	73.73	2.438	-14.52	0.147	2.28	0.285	-145.15	1.10	10.2
6.50	0.485	64.85	2.260	-23.66	0.155	-4.15	0.291	-150.18	1.10	9.7
7.00	0.498	55.95	2.109	-32.75	0.163	-10.60	0.287	-154.60	1.09	9.2
7.50	0.514	47.03	1.978	-41.81	0.170	-17.22	0.279	-158.90	1.09	8.8
8.00	0.533	38.18	1.861	-50.95	0.176	-23.96	0.262	-162.87	1.09	8.4
8.50	0.558	29.93	1.755	-60.07	0.181	-30.61	0.244	-168.45	1.09	8.1
9.00	0.586	22.10	1.658	-69.20	0.186	-37.43	0.224	-175.58	1.07	7.8
9.50	0.616	14.75	1.568	-78.26	0.190	-44.07	0.206	-176.14	1.06	7.7
10.00	0.643	8.23	1.489	-87.24	0.194	-50.92	0.191	-167.23	1.04	7.6
10.50	0.669	1.93	1.415	-96.42	0.196	-57.75	0.178	-158.39	1.02	7.7
11.00	0.691	-4.15	1.347	-105.57	0.198	-64.56	0.166	-151.79	1.00	8.2
11.50	0.709	-10.52	1.286	-114.82	0.200	-71.54	0.153	-147.66	0.99	8.1
12.00	0.725	-17.06	1.229	-124.30	0.201	-78.71	0.135	-147.52	0.98	7.9
12.50	0.746	-23.83	1.172	-133.88	0.202	-85.96	0.110	-151.92	0.97	7.6
13.00	0.766	-31.30	1.115	-143.85	0.200	-93.76	0.084	-160.86	0.97	7.5
13.50	0.787	-39.12	1.055	-153.89	0.196	-101.42	0.066	-176.40	0.98	7.3
14.00	0.809	-46.23	0.996	-163.89	0.191	-108.56	0.063	-144.57	0.99	7.2
14.50	0.829	-53.03	0.936	-173.90	0.186	-115.98	0.078	-121.33	1.00	6.6
15.00	0.847	-59.39	0.879	-176.00	0.180	-123.53	0.102	-112.73	1.02	6.0
15.50	0.864	-65.18	0.828	-165.89	0.173	-130.77	0.122	-114.28	1.03	5.8
16.00	0.875	-71.13	0.779	-155.45	0.166	-138.24	0.141	-119.68	1.06	5.2
16.50	0.879	-77.09	0.731	-144.58	0.158	-146.13	0.160	-127.09	1.14	4.4
17.00	0.885	-82.91	0.681	-133.70	0.148	-153.64	0.188	-133.94	1.24	3.7
17.50	0.888	-89.06	0.633	-122.64	0.137	-160.49	0.225	-141.26	1.40	2.9
18.00	0.887	-95.33	0.595	-112.04	0.129	-167.16	0.263	-146.76	1.56	2.2

Note:

1. Gain Calculations:

$$MAG = \frac{|S_{21}|}{|S_{12}|} (K \pm \sqrt{K^2 - 1})$$

When $K \leq 1$, MAG is undefined and MSG values are used. $MSG = \frac{|S_{21}|}{|S_{12}|}$, $K = \frac{1 + |\Delta|^2 - |S_{11}|^2 - |S_{22}|^2}{2 |S_{12} S_{21}|}$, $\Delta = S_{11} S_{22} - S_{21} S_{12}$

MAG = Maximum Available Gain

MSG = Maximum Stable Gain

NE662M04 NONLINEAR MODEL

SCHEMATIC

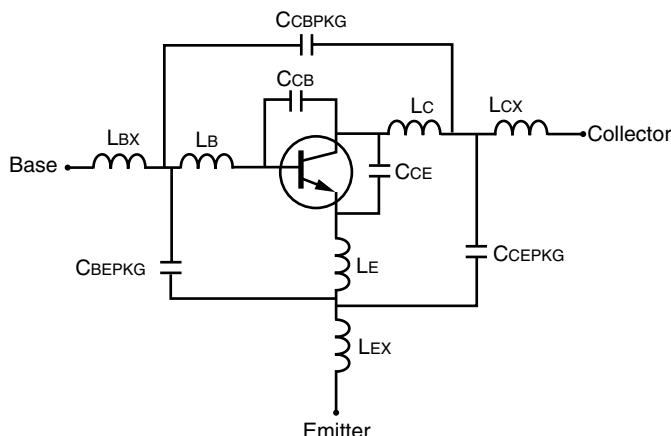

BJT NONLINEAR MODEL PARAMETERS (1)

Parameters	Q1	Parameters	Q1
IS	1.6e-16	MJC	0.3
BF	111	XCJC	0.3
NF	1.02	CJS	0
VAF	23	VJS	0.75
IKF	0.38	MJS	0
ISE	1e-6	FC	0.55
NE	30	TF	3e-12
BR	12	XTF	0.1
NR	1.02	VTF	0.8
VAR	2.5	ITF	0.14
IKR	0.1	PTF	23.5
ISC	3e-15	TR	1e-11
NC	1.28	EG	1.11
RE	0.77	XTB	0
RB	3.5	XTI	3
RBM	20	KF	0
IRB	1.3e-3	AF	1
RC	8.75		
CJE	0.4e-12		
VJE	0.6		
MJE	0.5		
CJC	0.1e-12		
VJC	0.75		

(1) Gummel-Poon Model

UNITS

Parameter	Units
time	seconds
capacitance	farads
inductance	henries
resistance	ohms
voltage	volts
current	amps

ADDITIONAL PARAMETERS

Parameters	NE662M04
CCB	0.09e-12
CCE	0.09e-12
LB	1.0e-9
LC	0.6e-9
LE	0.22e-9
CCBPKG	0.001e-12
CCEPKG	0.3e-12
CBEPK	0.21e-12
LBX	0.2e-9
LCX	0.2e-9
LEX	0.07e-9

MODEL RANGE

Frequency: 0.1 to 12 GHz
 Bias: VCE = 0.5 V to 3 V, IC = 1 mA to 20 mA
 Date: 01/12/2000

Life Support Applications

These NEC products are not intended for use in life support devices, appliances, or systems where the malfunction of these products can reasonably be expected to result in personal injury. The customers of CEL using or selling these products for use in such applications do so at their own risk and agree to fully indemnify CEL for all damages resulting from such improper use or sale.

Subject: Compliance with EU Directives

CEL certifies, to its knowledge, that semiconductor and laser products detailed below are compliant with the requirements of European Union (EU) Directive 2002/95/EC Restriction on Use of Hazardous Substances in electrical and electronic equipment (RoHS) and the requirements of EU Directive 2003/11/EC Restriction on Penta and Octa BDE.

CEL Pb-free products have the same base part number with a suffix added. The suffix –A indicates that the device is Pb-free. The –AZ suffix is used to designate devices containing Pb which are exempted from the requirement of RoHS directive (*). In all cases the devices have Pb-free terminals. All devices with these suffixes meet the requirements of the RoHS directive.

This status is based on CEL’s understanding of the EU Directives and knowledge of the materials that go into its products as of the date of disclosure of this information.

Restricted Substance per RoHS	Concentration Limit per RoHS (values are not yet fixed)	Concentration contained in CEL devices	
		-A	-AZ
Lead (Pb)	< 1000 PPM	Not Detected	(*)
Mercury	< 1000 PPM	Not Detected	
Cadmium	< 100 PPM	Not Detected	
Hexavalent Chromium	< 1000 PPM	Not Detected	
PBB	< 1000 PPM	Not Detected	
PBDE	< 1000 PPM	Not Detected	

If you should have any additional questions regarding our devices and compliance to environmental standards, please do not hesitate to contact your local representative.

Important Information and Disclaimer: Information provided by CEL on its website or in other communications concerning the substance content of its products represents knowledge and belief as of the date that it is provided. CEL bases its knowledge and belief on information provided by third parties and makes no representation or warranty as to the accuracy of such information. Efforts are underway to better integrate information from third parties. CEL has taken and continues to take reasonable steps to provide representative and accurate information but may not have conducted destructive testing or chemical analysis on incoming materials and chemicals. CEL and CEL suppliers consider certain information to be proprietary, and thus CAS numbers and other limited information may not be available for release.

In no event shall CEL’s liability arising out of such information exceed the total purchase price of the CEL part(s) at issue sold by CEL to customer on an annual basis.

See CEL Terms and Conditions for additional clarification of warranties and liability.