

4-bit REAL TIME CLOCK MODULE

RTC-7301SF/DG

Product number (please refer to page 2)

Q4273018x000200

Q4273011x000200

- Built-in crystal oscillator 32.768 kHz with frequency adjusted
- Frequency selectable clock output (32.768 kHz to 1/30 Hz)
- Built-in 30 second adjustment function, digital pace adjustment function (Max. adjustment: $\pm 192 \times 10^6$)
- Built-in alarm and timer interrupt functions.
- Built-in semiconductor temperature sensor (Voltage output: -7.8 mV / °C, RTC-7301SF)
- Operating voltage range: 2.4 V to 5.5 V, time keeping voltage range: 1.6 V to 5.5 V
- Low current consumption (0.6 μ A / 3 V Typ.)
- High speed parallel interface compatible with SRAM

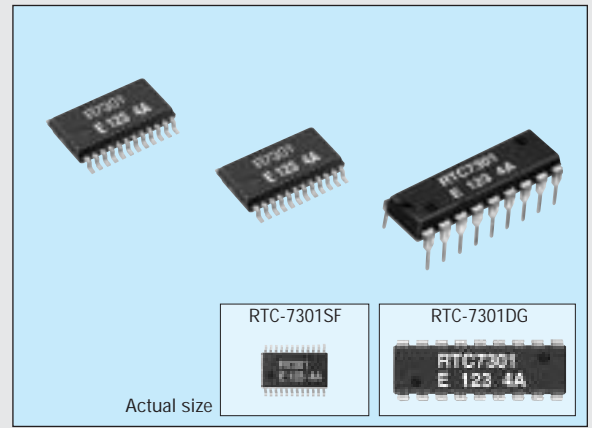

The details are mentioned in the application manual.

<http://www.epsondevice.com>

Specifications (characteristics)

Absolute Max. ratings

GND=0V

Item	Symbol	Condition	Min.	Max.	Unit
Supply voltage	V _{DD}	V _{DD} to GND	-0.3	+7.0	V
Input voltage	V _{IN}	Input terminal, D0 to D3 pins	GND -0.3	V _{DD} + 0.3	
Output voltage(1)	V _{OUT1}	$\overline{\text{IRQ}}$ pin	GND -0.3	+8.0	V
Output voltage(2)	V _{OUT2}	FOUT, D0-D3 pins, VTEMP pin	GND -0.3	V _{DD} + 0.3	
Storage temperature	T _{STG}	Stored as bare product after unpacking	-55	+125	°C

Operating conditions

GND=0V

Item	Symbol	Condition	Min.	Max.	Unit
Power voltage	V _{DD}	—	2.4	5.5	V
Clock voltage	V _{CLK}	—	1.6	5.5	V
Operating temperature	T _{OPR}	No condensation	-40	+85	°C

Frequency characteristics

Item	Symbol	Condition	Range	Unit
Frequency precision	$\Delta f/f_0$	T _a =+25 °C, V _{DD} = 3.0 V	5 ± 23 *	x 10 ⁻⁶
Oscillation start-up time	t _{STA}	T _a =+25 °C, V _{DD} = 2.4 V	3 Max.	s
Frequency temperature characteristics	T _{OP}	T _a =-10 °C to +70 °C, V _{DD} = 3.0 V	+10/-120	x 10 ⁻⁶
Frequency voltage characteristics	f/V	T _a =+25 °C, V _{DD} = 1.6 V to 5.5V	±2	x 10 ⁴ /V
Aging	f _a	T _a =+25 °C, V _{DD} = 3.0 V	±5	x 10 ⁴ /year

* Please ask tighter tolerance

DC characteristics

GND=0 V, V_{DD}=1.6 V to 5.5 V, T_a= -40 °C to +85 °C

Item	Symbol	Condition	Min.	Typ.	Max.	Unit
Current consumption (When non-accessed)	I _{DD1}	V _{DD} = 5 V	—	1.0	2.0	μA
		V _{DD} = 3 V	—	0.6	1.0	μA

CS₀, RD, WR = V_{DD}
A₀-A₃, CS₁ = GND
D₀-D₃, IRQ = Hi-Z
FOUT = Hi-Z (OFF)
VTEMP = Hi-Z (OFF)

Note) There is no VTEMP pin on the RTC-7301DG so standards for the VTEMP pin within the conditions described above do not apply.

Temperature sensor characteristics

GND=0 V, T_a= -40 °C to +85 °C

Item	Symbol	Condition	Min.	Typ.	Max.	Unit
Temperature output voltage	VTEMP	T _a = +25 °C, GND based output voltage VTEMP pins, V _{DD} =2.7 V to 5.5 V		1.470		V
Output precision	T _{ACR}	T _a = +25 °C, V _{DD} =2.7 V to 5.5 V			±5.0	°C
Temperature sensitivity	V _{SE}	-40 °C ≤ T _a ≤ +85 °C, V _{DD} =2.7 V to 5.5 V	-7.3	-7.8	-8.3	mV/°C
Linearity	ΔNL	-40 °C ≤ T _a ≤ +85 °C, V _{DD} =2.7 V to 5.5 V			±2.0	%
Temperature detection range	T _{SOP}	ΔNL ≤ ± 2.0 %, V _{DD} =2.7 V to 5.5 V	-40		+85	°C
Output resistance	R _o	T _a = +25 °C, VTEMP pins, V _{DD} =2.7 V to 5.5 V GND standard and V _{DD} standard		1.0	3.0	kΩ
Load condition	C _L	V _{DD} =2.7 V to 5.5 V			100	pF
	R _L	V _{DD} =2.7 V to 5.5 V	500			kΩ
Response time	t _{rsp}	V _{DD} =3.3 V, C _L =50 pF, R _L =500 kΩ, Max. ±1 °C			200	μs

Note) There is no temperature sensor function on the RTC-7301DG.

Terminal connection

RTC-7301SF

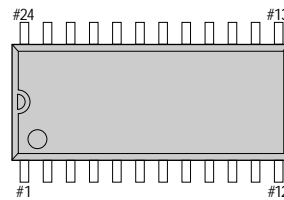

No.	Pin terminal	No.	Pin terminal
1	CS ₀	24	V _{DD}
2	FOUT	23	(V _{DD})
3	FO _{2T}	22	(V _{DD})
4	VTEMP	21	(V _{DD})
5	(V _{DD})	20	(V _{DD})
6	IRQ	19	(V _{DD})
7	A ₀	18	CS ₁
8	A ₁	17	D ₀
9	A ₂	16	D ₁
10	A ₃	15	D ₂
11	RD	14	D ₃
12	GND	13	WR

RTC-7301DG

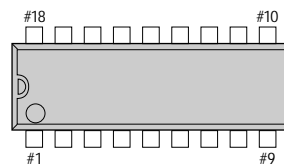

No.	Pin terminal	No.	Pin terminal
1	CS ₀	18	V _{DD}
2	FOUT	17	(V _{DD})
3	IRQ	16	(V _{DD})
4	A ₀	15	CS ₁
5	A ₁	14	D ₀
6	A ₂	13	D ₁
7	A ₃	12	D ₂
8	RD	11	D ₃
9	GND	10	WR

• (V_{DD}) and V_{DD} are to have the same level of voltage. Do not connect it to any external terminals.

External dimensions

(Unit: mm)

RTC-7301SF (SSOP 24-pin)

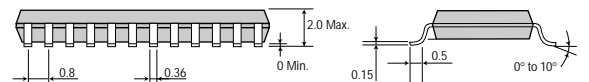
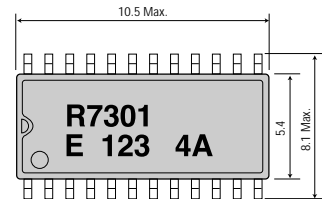

Metal may be exposed on the top or bottom of this product. This won't affect any quality, reliability or electrical spec.

RTC-7301DG (DIP 18-pin)

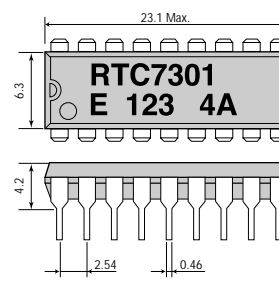

Register table

Bank0 Clock and calendar registers

Address	Register	bit 3	bit 2	bit 1	bit 0
0	1 second digit	8	4	2	1
1	10 second digit	Fos	40	20	10
2	1 minute digit	8	4	2	1
3	10 minute digit	o	40	20	10
4	1hour digit	8	4	2	1
5	10 hour digit	o	o	20	10
6	Day digit	o	4	2	1
7	1 day digit	8	4	2	1
8	10 day digit	o	o	20	10
9	1 month digit	8	4	2	1
A	10 month digit	o	o	o	10
B	1 year digit	8	4	2	1
C	10 year digit	80	40	20	10
D	100 year digit	800	400	200	100
E	1000 year digit	TEST	TEMP	2000	1000
F	Control registers	Bank Sel 1	Bank Sel 0	STOP	BUSY/ADJ

Bank1 Alarms and FOUT registers

Address	Register	bit 3	bit 2	bit 1	bit 0
0	1 second digit	8	4	2	1
1	10 second digit	AE	40	20	10
2	1 minute digit	8	4	2	1
3	10 minute digit	AE	40	20	10
4	1hour digit	8	4	2	1
5	10 hour digit	AE	•	20	10
6	Day digit	AE	4	2	1
7	1 day digit	8	4	2	1
8	10 day digit	AE	•	20	10
9	—	•	•	•	•
A	—	•	•	•	•
B	CS1 Controller	CTEMP	CDT_ON	•	•
C	FOUT divider ratio setting register	o	FD2	FD1	FD0
D	FOUT divider ratio setting register	FE	o	FD4	FD3
E	Alarm control	TEST	TEMP	AF	AIE
F	Control register	Bank Sel 1	Bank Sel 0	STOP	BUSY/ADJ

Bank2 Digital offset and timer registers

Address	Registers	bit 3	bit 2	bit 1	bit 0
0	Digital offset	DT3	DT2	DT1	DT0
1		DT_ON	DT6	DT5	DT4
2	—	o	o	o	o
3	—	o	o	o	o
4	Timer counter preset value	8	4	2	1
5		128	64	32	16
6	Timer counter data	8	4	2	1
7		128	64	32	16
8	Timer settings	TE	TI/TP	TD1	TD0
9	—	o	o	o	o
A	—	o	o	o	o
B	—	o	o	o	o
C	—	o	o	o	o
D	—	o	o	o	o
E	Timer control	TEST	TEMP	TF	TIE
F	Control register	Bank Sel 1	Bank Sel 0	STOP	BUSY/ADJ

Reading data

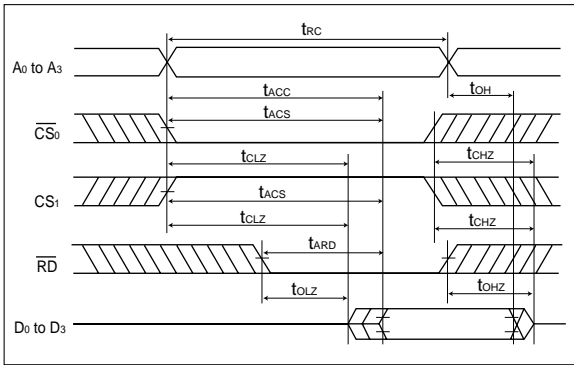

Writing data (CS Control)

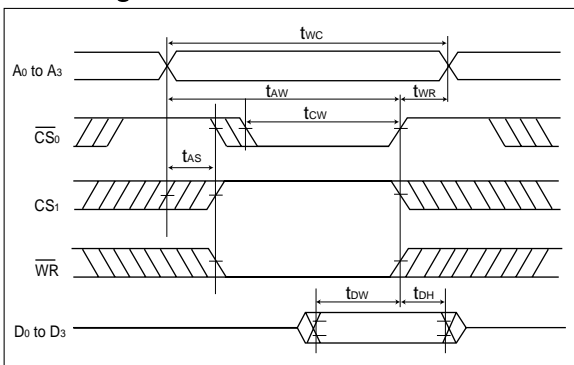

Writing data (WR Control)

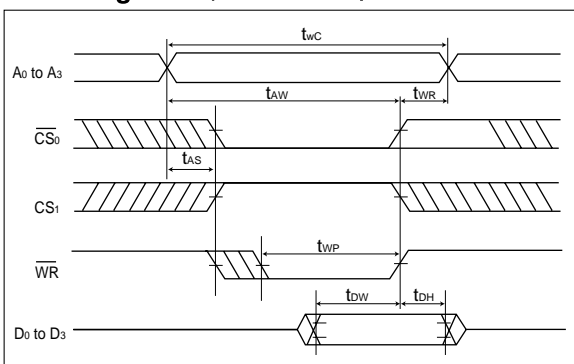

AC characteristics

*GND=0 V, Ta=-40 °C to +85 °C •Input conditions: VI= 0.5 x VDD, VO= 0.5 x VDD •Output load: CL= 100 pF (IACC,IACS,IARD)

Item	Symbol	Condition	VDD=2.4 to 3.6 V		VDD=4.5 to 5.5 V		Unit
			Min.	Max.	Min.	Max.	
Read cycle time	t _{RC}	—	150	—	85	—	ns
Address access time	t _{ACC}	—	—	150	—	85	ns
CE access time	t _{ACS}	—	—	150	—	85	ns
RD access time	t _{ARD}	—	—	100	—	45	ns
CE output set time	t _{CLZ}	—	5	—	3	—	ns
CE output floating	t _{CHZ}	—	—	60	—	30	ns
RD output set time	t _{OLZ}	—	5	—	3	—	ns
RD output floating	t _{OHZ}	—	—	60	—	30	ns
Output hold time	t _{OH}	—	10	—	5	—	ns
Write cycle time	t _{WC}	—	150	—	85	—	ns
Chip select time	t _{CW}	—	140	—	70	—	ns
Address valid end of write	t _{AW}	—	140	—	70	—	ns
Address setup time	t _{AS}	—	0	—	0	—	ns
Address hold time	t _{WR}	—	0	—	0	—	ns
Write pulse width	t _{WP}	—	130	—	65	—	ns
Input data set time	t _{DW}	—	80	—	35	—	ns
Input data hold time	t _{DH}	—	0	—	0	—	ns
FOUT output frequency duty	DUTY	FOUT= 32.768 kHz	40	60	40	60	%

Block diagram

