

## CMOS LDO Regulators for Portable Equipments

## 1ch 200mA

## CMOS LDO Regulators



BU□□TD2WNVX series

No.11020ECT07

**●Description**

BU□□TD2WNVX series is high-performance FULL CMOS regulator with 200-mA output, which is mounted on micro miniature package SSON004X1010 (1.0 mm × 1.0 mm × 0.6 mm). It has excellent noise characteristics and load responsiveness characteristics despite its low circuit current consumption of 35μA. It is most appropriate for various applications such as power supplies for logic IC, RF, and camera modules. Micro miniature SSON004X1010 with built-in heatsink is adopted for the package, which contributes to the space-saving design of the set.

**●Features**

- 1) High-accuracy output voltage of ±1% (±25 mV on Vout<2.5V products)
- 2) High ripple rejection: 70 dB (Typ., 1 kHz,)
- 3) Compatible with small ceramic capacitor (CIN=Co=0.47 μF)
- 4) Low current consumption: 35 μA
- 5) ON/OFF control of output voltage
- 6) With built-in overcurrent protection circuit and thermal shutdown circuit
- 7) With built-in output discharge circuit
- 8) Adopting ultra-small package SSON004X1010

**●Applications**

Battery-powered portable equipment, etc.

**●Line up**
**■200 mA BU□□TD2WNVX Series**

Product Name	1.0	1.2	1.5	1.8	1.85	1.9	2.0	2.05	2.1	2.3	2.5	Package
BU□□TD2WNVX	○	○	○	○	○	○	○	○	○	○	○	SSON004X1010
	2.6	2.7	2.8	2.85	2.9	3.0	3.1	3.2	3.3	3.4		
	○	○	○	○	○	○	○	○	○	○		

Model name : BU□□TD2WNVX

a

Symbol	Contents							
	Specification of output voltage							
a	□□	Output voltage (V)	□□	Output voltage (V)	□□	Output voltage (V)	□□	Output voltage (V)
	10	1.0 V(Typ.)	20	2.0 V(Typ.)	27	2.7 V(Typ.)	32	3.2 V(Typ.)
	12	1.2 V(Typ.)	2A	2.05 V(Typ.)	28	2.8 V(Typ.)	33	3.3 V(Typ.)
	15	1.5 V(Typ.)	21	2.1 V(Typ.)	2J	2.85 V(Typ.)	34	3.4 V(Typ.)
	18	1.8 V(Typ.)	23	2.3V(Typ.)	29	2.9 V(Typ.)		
	1J	1.85 V(Typ.)	25	2.5 V(Typ.)	30	3.0 V(Typ.)		
	19	1.9 V(Typ.)	26	2.6 V(Typ.)	31	3.1 V(Typ.)		

●Absolute maximum ratings

Parameter	Symbol	Ratings	Unit
Maximum applied power voltage	VMAX	-0.3 ~ +6.5	V
Power dissipation	Pd	560 <sup>(*1)</sup>	mW
Maximum junction temperature	TjMAX	+125	°C
Operational temperature range	Topr	-40 ~ +85	°C
Storage temperature range	Tstg	-55 ~ +125	°C

(\*1) When PCB (70 mm × 70 mm, thickness 1.6-mm glass epoxy) a standard ROHM board is implemented.  
Reduced to 5.6 mW/°C when used at Ta=25°C or higher.

●Recommended operating range (Do not exceed Pd.)

Parameter	Symbol	Ratings	Unit
Input power supply voltage	VIN	1.7 ~ 5.5	V
Maximum output current	IMAX	200	mA

●Recommended operating conditions

Parameter	Symbol	Ratings			Unit	Conditions
		Min.	Typ.	Max.		
Input capacitor	CIN	0.22 <sup>(*2)</sup>	0.47	—	μF	A ceramic capacitor is recommended.
Output capacitor	Co	0.22 <sup>(*2)</sup>	0.47	—	μF	A ceramic capacitor is recommended.

(\*2) Set the capacity value of the capacitor so that it does not fall below the minimum value, taking temperature characteristics, DC device characteristics, and change with time into consideration.

●Electrical characteristics(Ta=25°C, VIN=VOUT+1.0V<sup>(\*)3</sup>, STBY=VIN, CIN=0.47μF, Co=0.47μF, unless otherwise noted.)

Parameter	Symbol	Limits			Unit	Conditions	
		Min.	Typ.	Max.			
<b>Overall Device</b>							
Output Voltage	VOUT	VOUT ×0.99	VOUT	VOUT ×1.01	V	IOUT=10μA, VOUT ≥ 2.5V	
		VOUT -25mV		VOUT +25mV		IOUT=10μA, VOUT < 2.5V	
Operating Current	IIN	-	35	60	μA	IOUT=0mA	
Operating Current (STBY)	ISTBY	-	-	1.0	μA	STBY=0V	
Ripple Rejection Ratio	RR	45	70	-	dB	VRR=-20dBv, fRR=1kHz, IOUT=10mA	
Dropout Voltage	VSAT	-	280	540	mV	2.5V ≤ VOUT ≤ 2.6V (VIN=0.98*VOUT, IOUT=200mA)	
		-	260	500	mV	2.7V ≤ VOUT ≤ 2.85V (VIN=0.98*VOUT, IOUT=200mA)	
		-	240	460	mV	2.9V ≤ VOUT ≤ 3.1V (VIN=0.98*VOUT, IOUT=200mA)	
		-	220	420	mV	3.2V ≤ VOUT ≤ 3.4V (VIN=0.98*VOUT, IOUT=200mA)	
Line Regulation	VDL	-	2	20	mV	VIN=VOUT+1.0V to 5.5V <sup>(*)4</sup> IOUT=10μA	
Load Regulation	VDLO	-	10	80	mV	IOUT=0.01mA to 100mA	
<b>Over-current Protection (OCP)</b>							
Limit Current	ILMAX	220	400	700	mA	Vo=VOUT*0.95	
Short Current	ISHORT	20	70	150	mA	Vo=0V	
<b>Standby Block</b>							
Discharge Resistor	RDSC	20	50	80	Ω	VIN=4.0V, STBY=0V, VOUT=4.0V	
STBY Pin Pull-down Current	ISTB	0.1	0.6	2.0	μA	STBY=1.5V	
STBY Control Voltage	ON	VSTBH	1.2	-	5.5	V	
	OFF	VSTBL	-0.3	-	0.3	V	

\* This product does not have radiation-proof design.

(\*)3 VIN=2.5V for VOUT ≤ 1.5V

(\*)4 VIN=2.5V to 5.5V for VOUT ≤ 1.5V

●Electrical characteristics of each Output Voltage

(Ta=25°C, STBY=VIN, CIN=0.47μF, Co=0.47μF, unless otherwise noted.)

Parameter	Symbol	Limits			Unit	Conditions
		Min.	Typ.	Max.		
1.2V	Maximum output current	80	160	-	mA	VIN=1.7V
		200	-	-		VIN=2.1V
1.5V		60	120	-		VIN=1.8V
		200	-	-		VIN=2.2V
1.8V		200	-	-		VIN=2.4V
1.9V		200	-	-		VIN=2.5V

●Block diagram, recommended circuit diagram, and pin configuration diagram

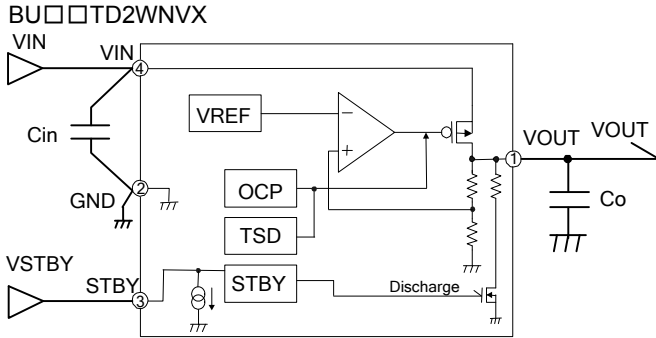

PIN No.	Symbol	Function
1	VOUT	Voltage output
2	GND	Grounding
3	STBY	ON/OFF control of output voltage (High: ON, Low: OFF)
4	VIN	Power input

Recommended ceramic capacitor for Cin & Co  
Murata Manufacturing Co., Ltd.  
GRM188B11A474KA61D

Fig.1 Recommended circuit diagram

●Input / Output terminal equivalent circuit schematic

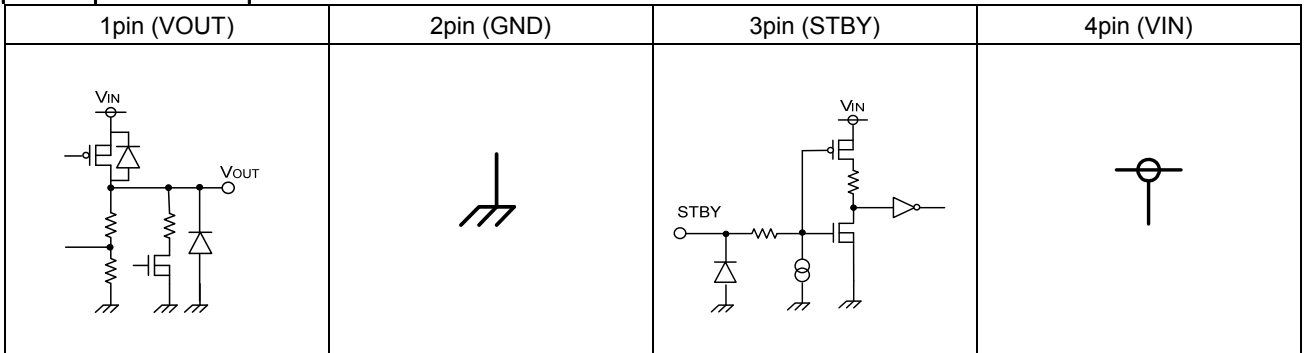

Fig.2 Input/Output equivalent circuit

●About input/output capacitor

It is recommended to place a capacitor as close as possible to the pins between the input terminal and GND or between the output terminal and GND.

The capacitor between the input terminal and GND becomes valid when source impedance increases or when wiring is long. The larger the capacity of the output capacitor between the output terminal and GND is, the better the stability and characteristics in output load fluctuation become.

However, please check the status of actual implementation. Ceramic capacitors generally have variation, temperature characteristics, and direct current bias characteristics and the capacity value also decreases with time depending on the usage conditions. It is recommended to select a ceramic capacitor upon inquiring about detailed data of the related manufacturer.

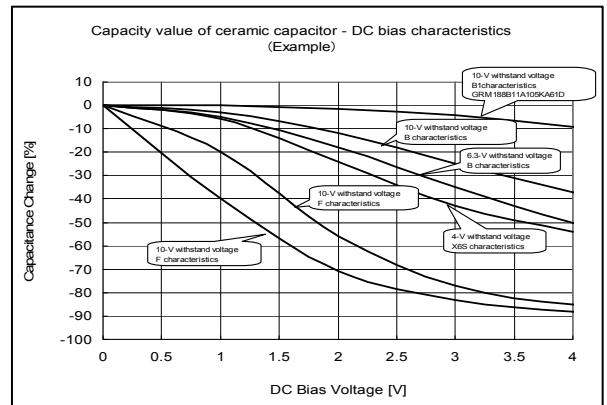

Fig.3 Capacity – bias characteristics

●About the equivalent series resistance (ESR) of a ceramic capacitor

Capacitors generally have ESR (equivalent series resistance) and it operates stably in the ESR-IOUT area shown on the right. Since ceramic capacitors, tantalum capacitors, electrolytic capacitors, etc. generally have different ESR, please check the ESR of the capacitor to be used and use it within the stability area range shown in the right graph for evaluation of the actual application.

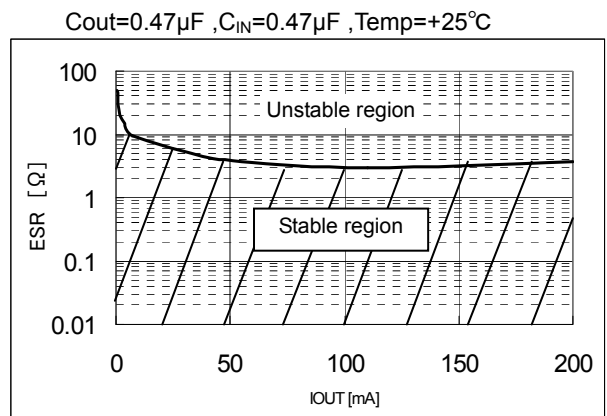

Fig.4 Stability area characteristics (Example)

●Reference data BU12TD2WNVX (Ta=25°C unless otherwise specified.)

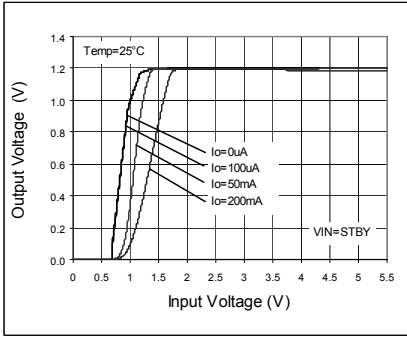

Fig.5. Output Voltage

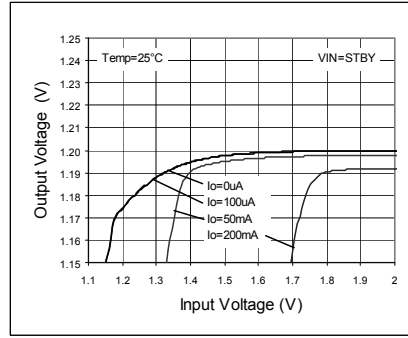

Fig.6. Line Regulation

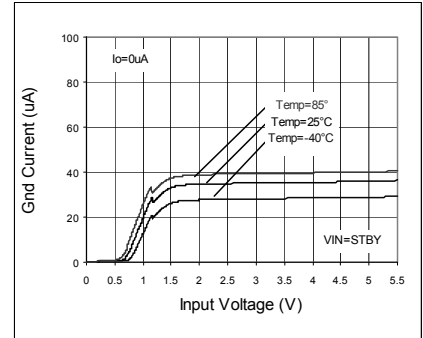

Fig.7. Circuit Current IGND

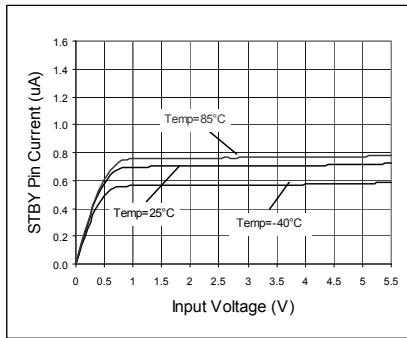

Fig.8. VSTBY - ISTBY

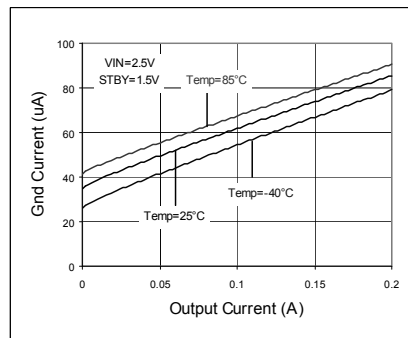

Fig.9. IOUT - IGND

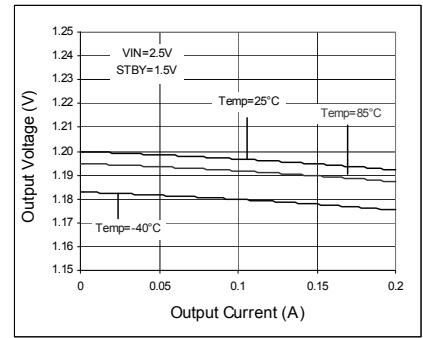

Fig.10. Load Regulation

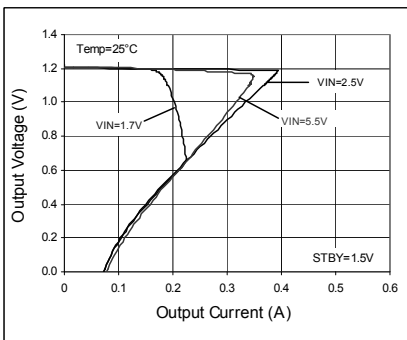

Fig.11. OCP Threshold

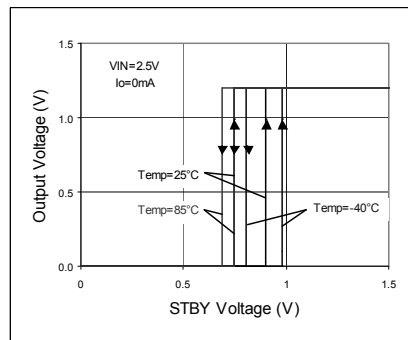

Fig.12. STBY Threshold

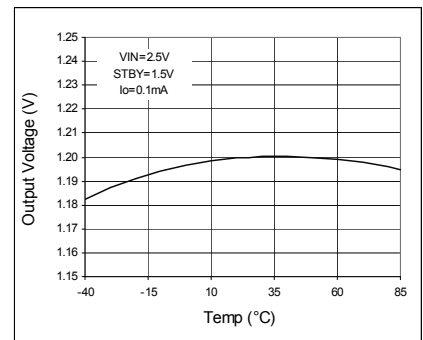

Fig.13. VOUT - Temp

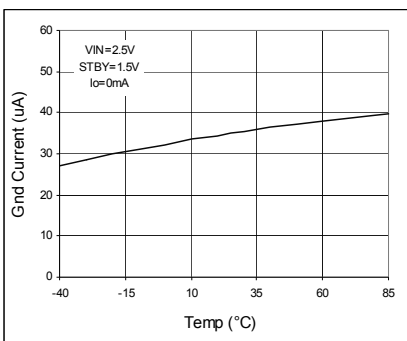

Fig.14. IGND vs Temp

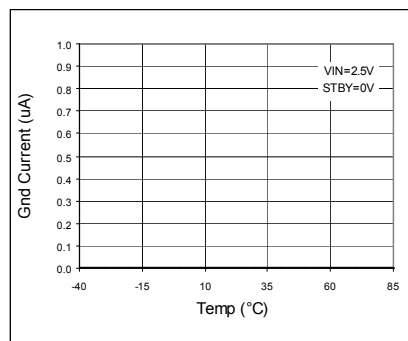

Fig.15. IGND - Temp (STBY)

●Reference data BU12TD2WNVX (Ta=25 °C unless otherwise specified.)

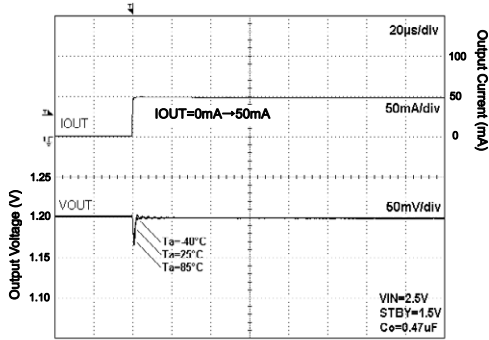

Fig.16. Load Response

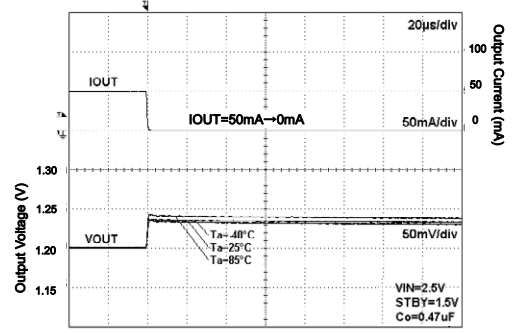

Fig.17. Load Response

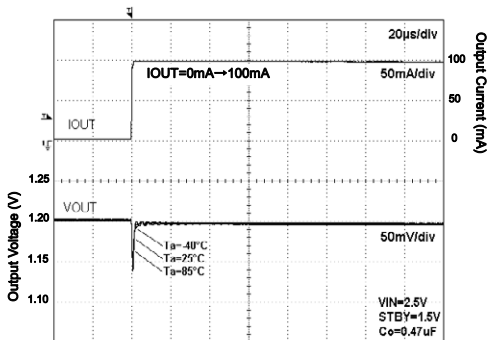

Fig.18. Load Response

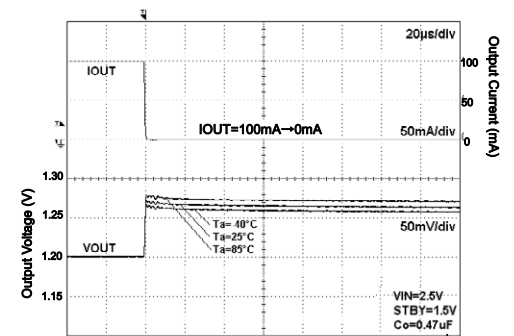

Fig.19. Load Response

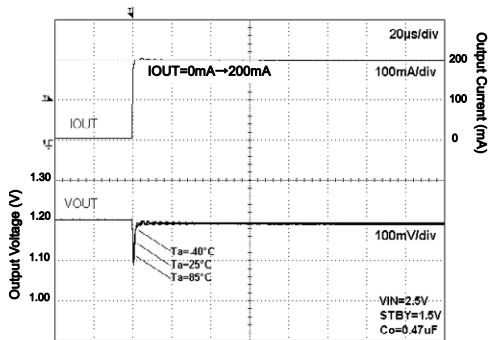

Fig.20. Load Response

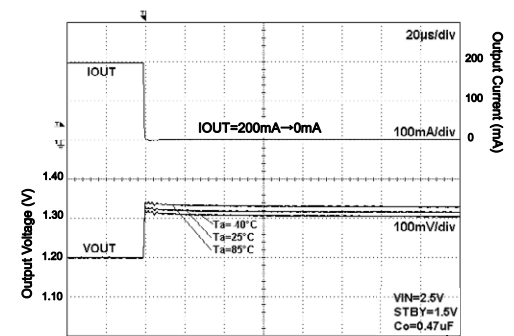

Fig.21. Load Response

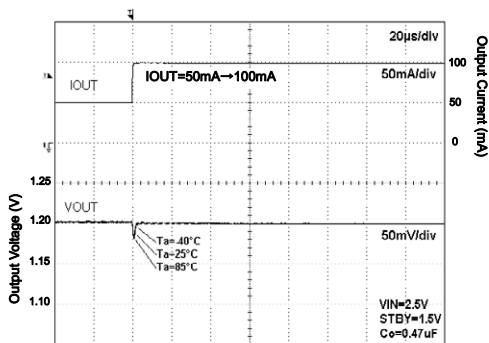

Fig.22. Load Response

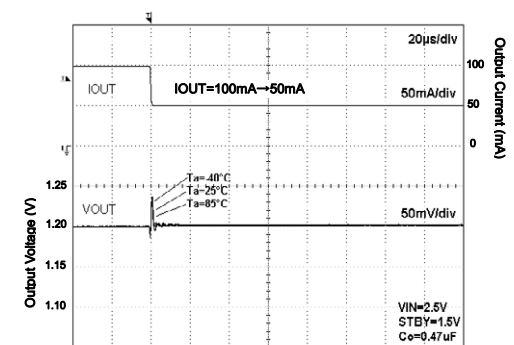

Fig.23. Load Response

●Reference data BU12TD2WNVX (Ta=25°C unless otherwise specified.)

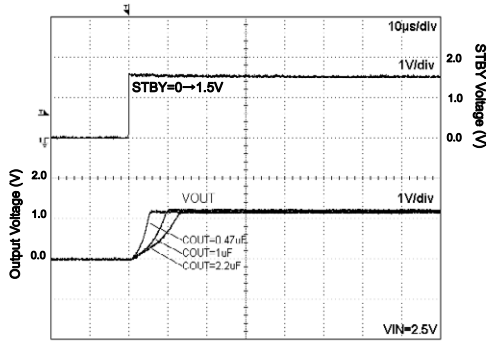

Fig.24. Start Up Time  
Iout=0mA

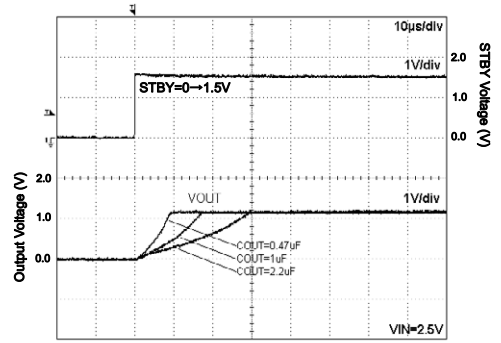

Fig.25. Start Up Time  
Iout=200mA

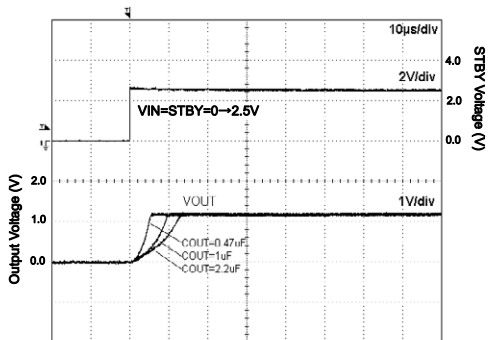

Fig.26. Start Up Time  
(VIN=STBY) Iout=0mA

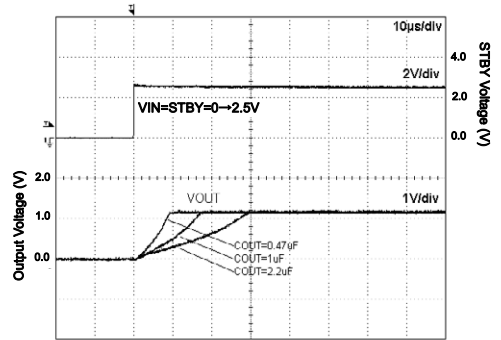

Fig.27. Start Up Time  
(VIN=STBY) Iout=200mA

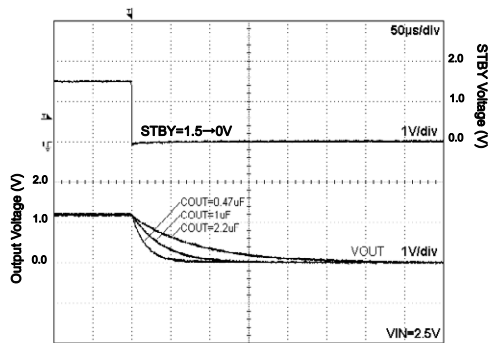

Fig.28. Discharge Time

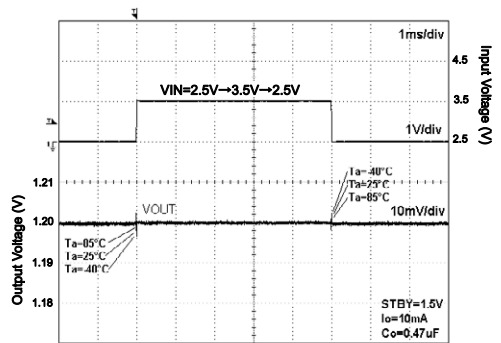

Fig.29. VIN Response

●Reference data BU15TD2WNVX (Ta=25°C unless otherwise specified.)

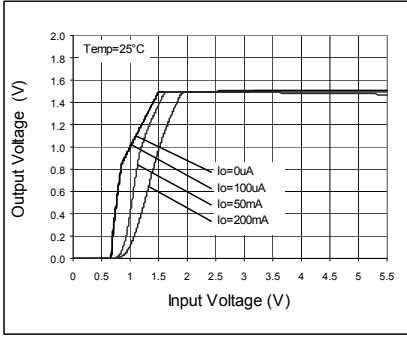

Fig.30. Output Voltage

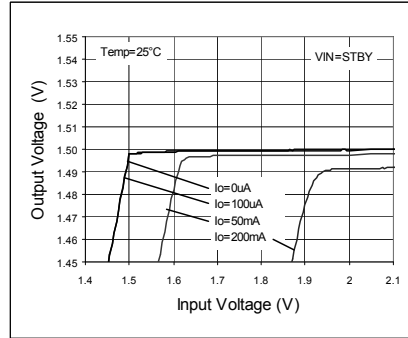

Fig.31. Line Regulation

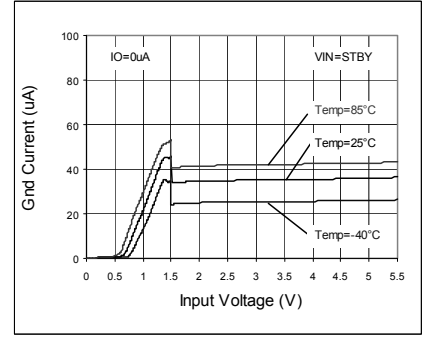

Fig.32. Circuit Current IGND

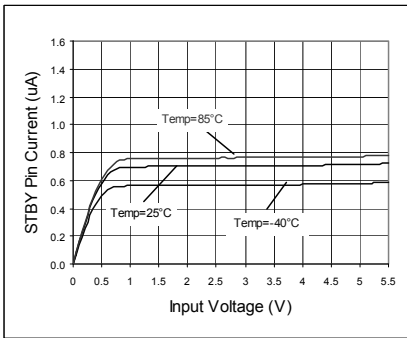

Fig.33. VSTBY - ISTBY

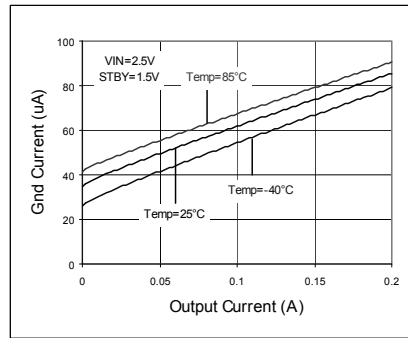

Fig.34. IOU - IGND

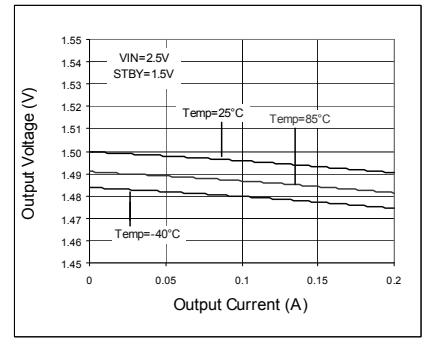

Fig.35. Load Regulation

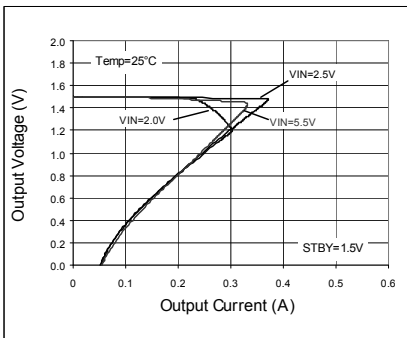

Fig.36. OCP Threshold

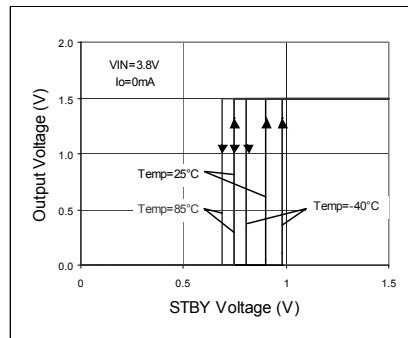

Fig.37. STBY Threshold

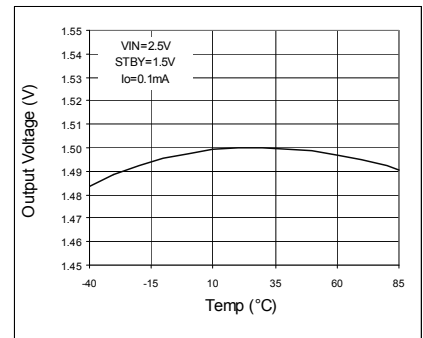

Fig.38. VOUT - Temp

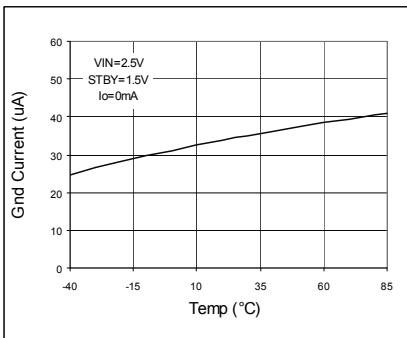

Fig.39. IGND vs Temp

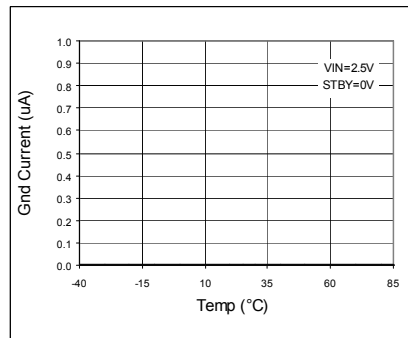

Fig.40. IGND vs Temp (STBY)



●Reference data BU15TD2WNVX (Ta=25°C unless otherwise specified.)

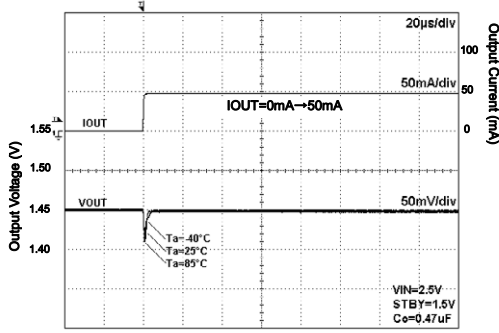

Fig.41. Load Response

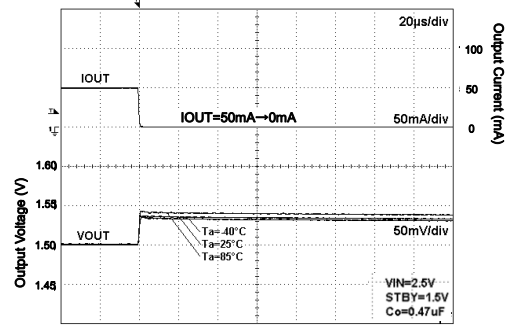

Fig.42. Load Response

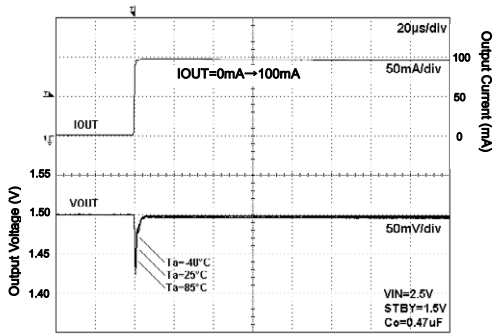

Fig.43. Load Response

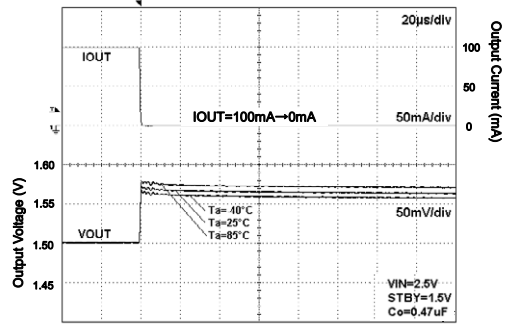

Fig.44. Load Response

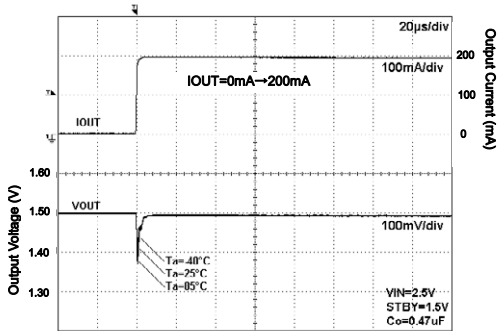

Fig.45. Load Response

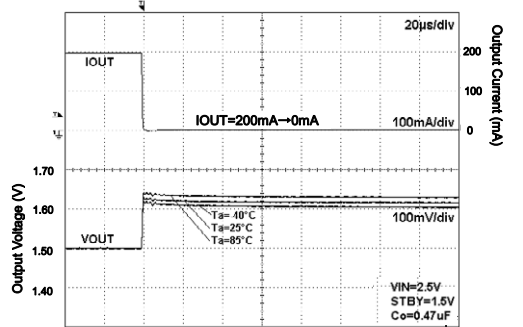

Fig.46. Load Response

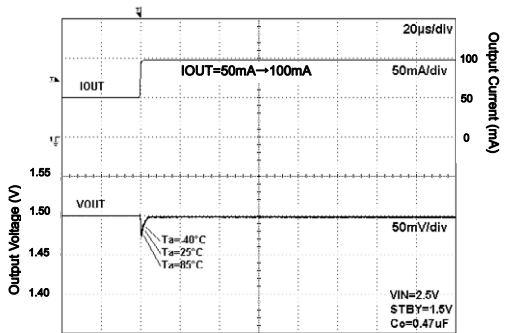

Fig.47. Load Response

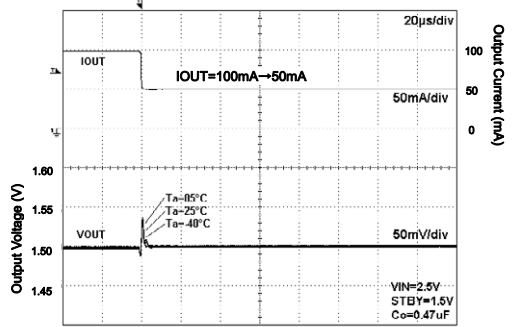

Fig.48. Load Response

●Reference data BU15TD2WNVX (Ta=25°C unless otherwise specified.)

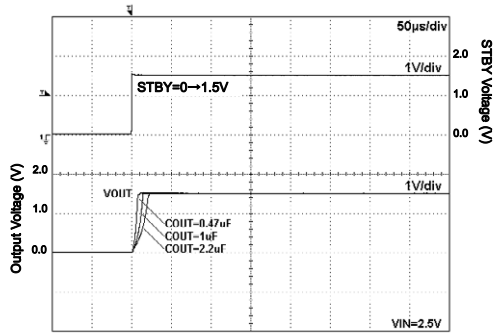

Fig.49. Start Up Time  
Iout=0mA

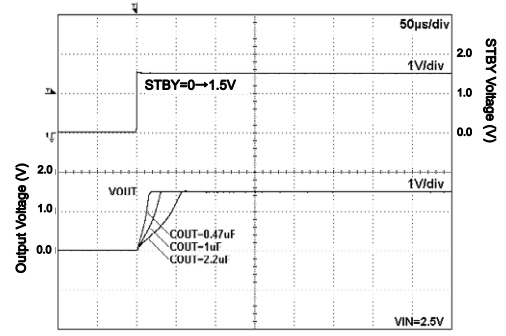

Fig.50. Start Up Time  
Iout=200mA

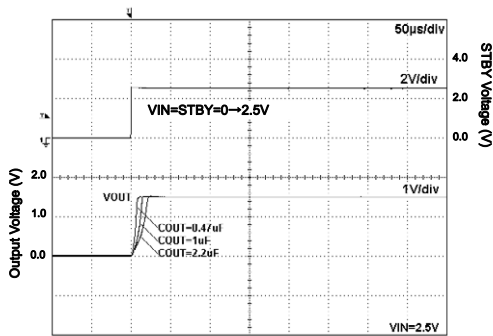

Fig.51. Start Up Time  
(VIN=STBY) Iout=0mA

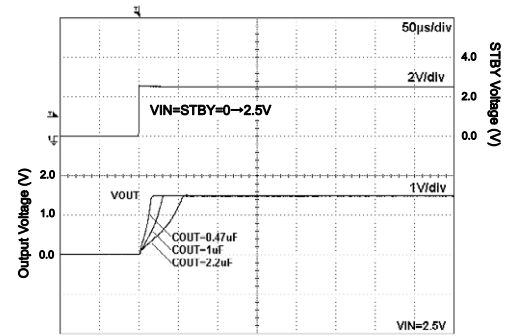

Fig.52. Start Up Time  
(VIN=STBY) Iout=200mA

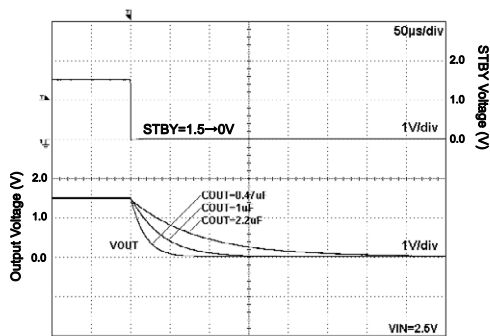

Fig.53. Discharge Time

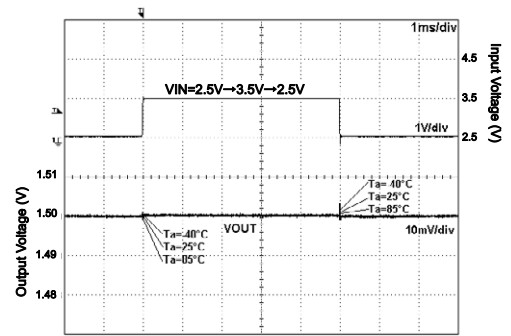

Fig.54. VIN Response

●Reference data BU18TD2WNVX (Ta=25°C unless otherwise specified.)

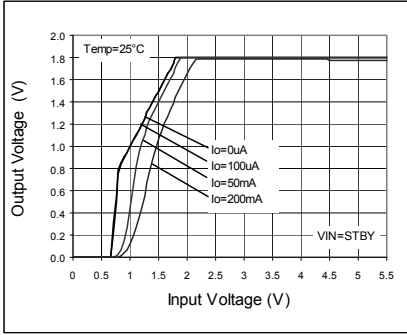

Fig.55. Output Voltage

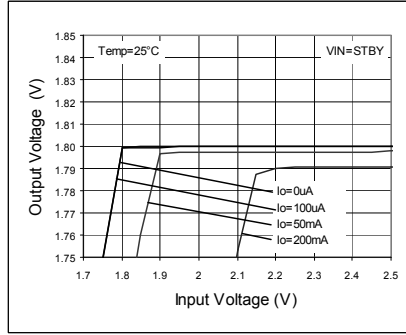

Fig.56. Line Regulation

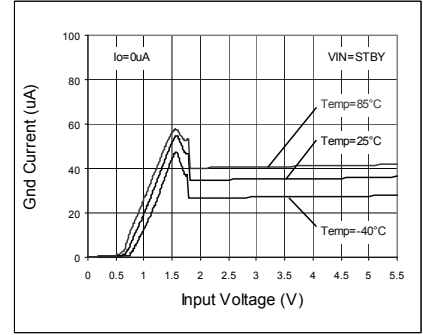

Fig.57. Circuit Current IGND

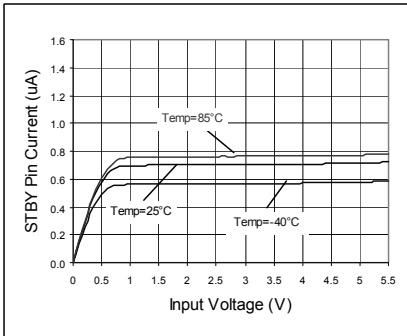

Fig.58. VSTBY - ISTBY

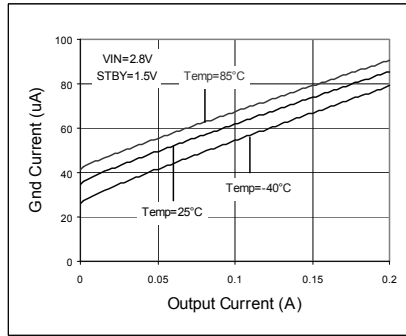

Fig.59. IOUT - IGDND

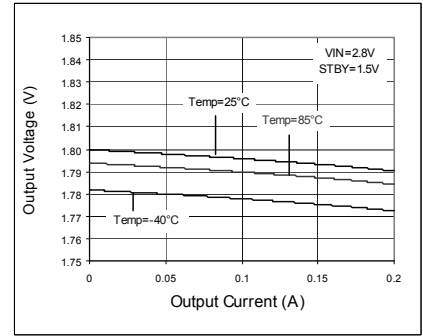

Fig.60. Load Regulation

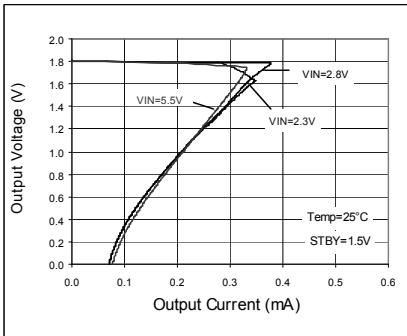

Fig.61. OCP Threshold

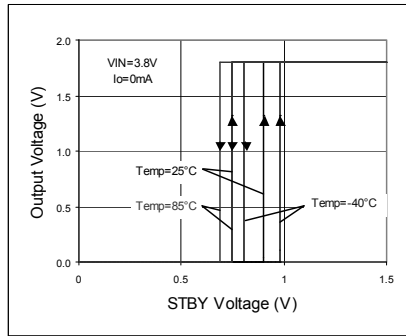

Fig.62. STBY Threshold

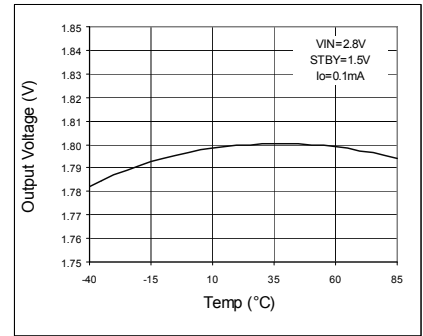

Fig.63. VOUT - Temp

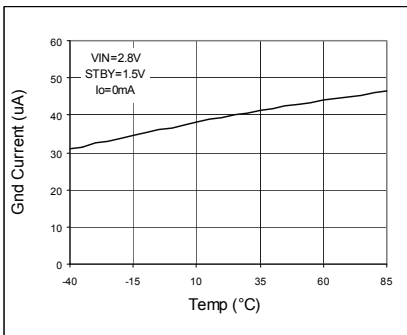

Fig.64. IGDND - Temp

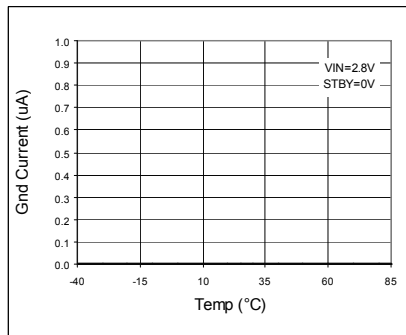

Fig.65. IGDND - Temp (STBY)

●Reference data BU18TD2WNVX (Ta=25°C unless otherwise specified.)

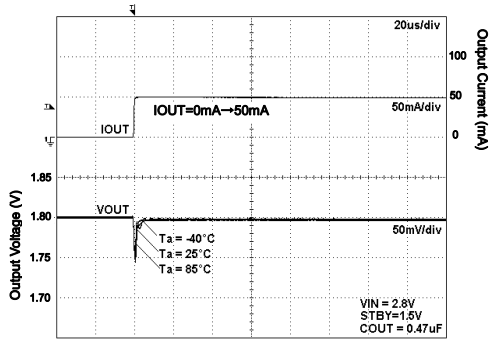

Fig.66. Load Response

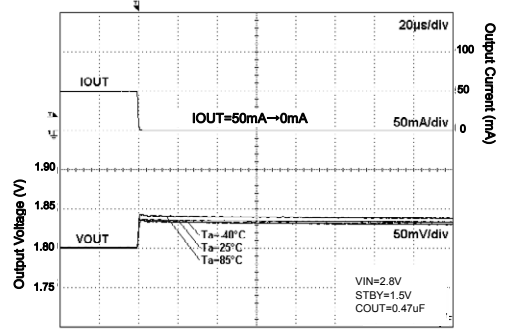

Fig.67. Load Response

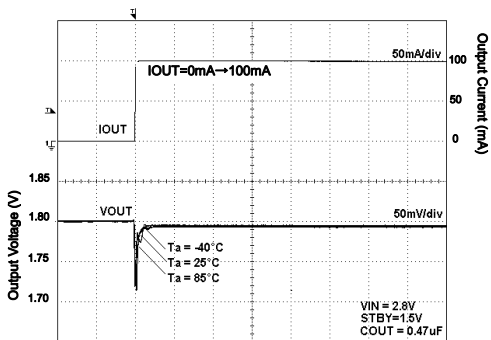

Fig.68. Load Response

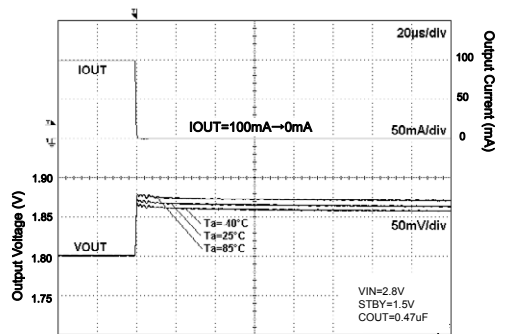

Fig.69. Load Response

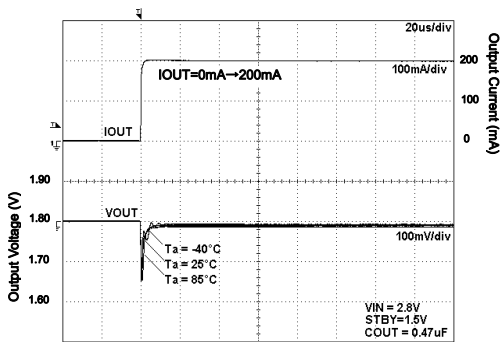

Fig.70. Load Response

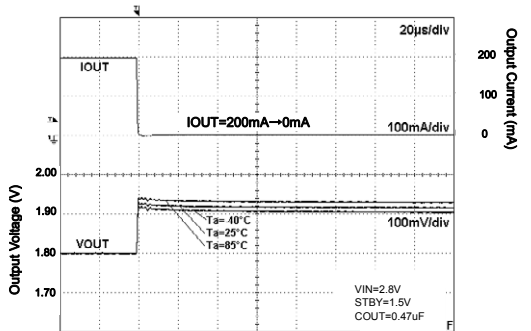

Fig.71. Load Response

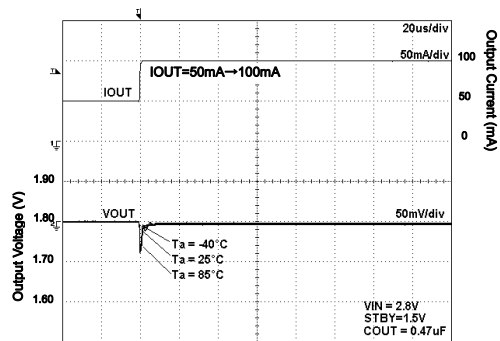

Fig.72. Load Response

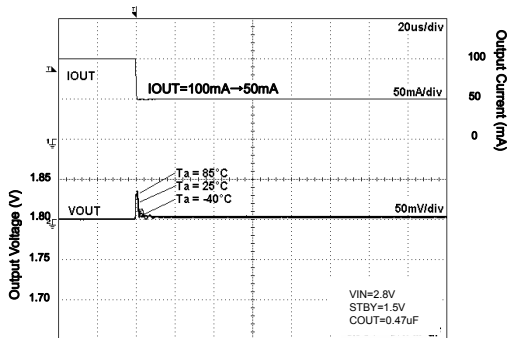

Fig.73. Load Response

●Reference data BU18TD2WNVX (Ta=25°C unless otherwise specified.)

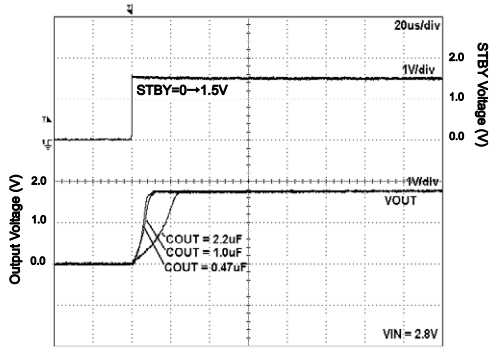

Fig.74. Start Up Time  
Iout=0mA

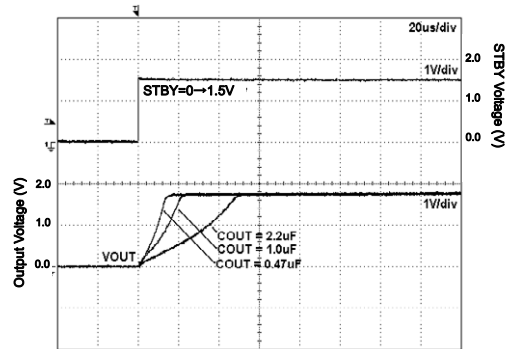

Fig.75. Start Up Time  
Iout=200mA

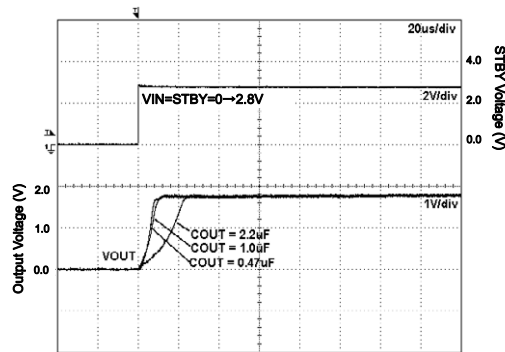

Fig.76. Start Up Time  
(VIN=STBY) Iout=0mA  
Iout=0mA

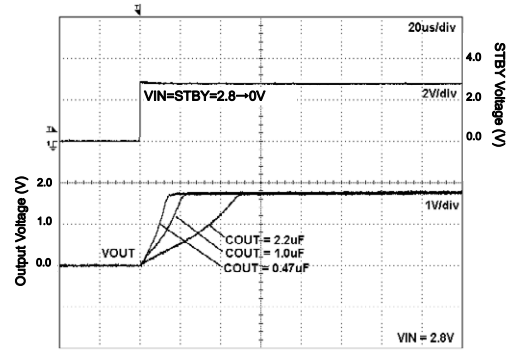

Fig.77. Start Up Time  
(VIN=STBY) Iout=200mA

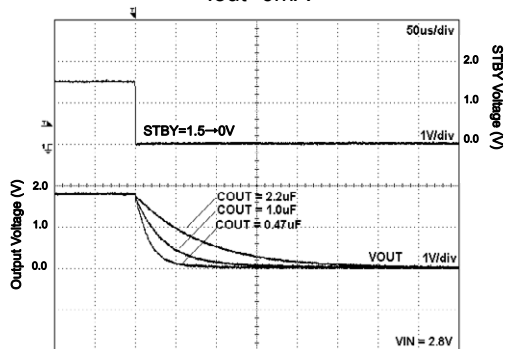

Fig.78. Discharge Time

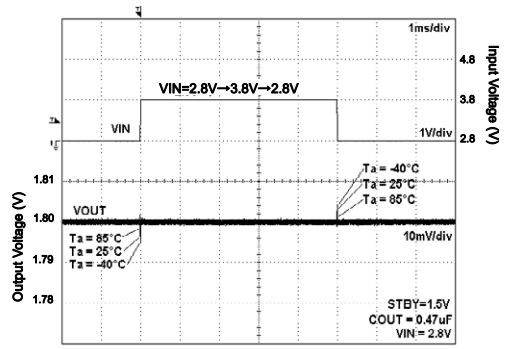

Fig.79. VIN Response

●Reference data BU19TD2WNVX (Ta=25°C unless otherwise specified.)

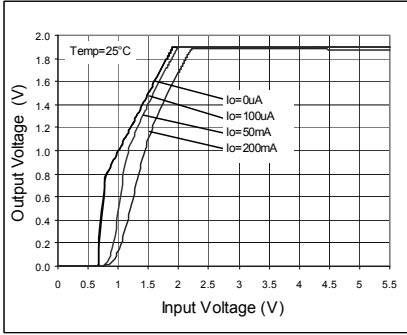

Fig.80. Output Voltage

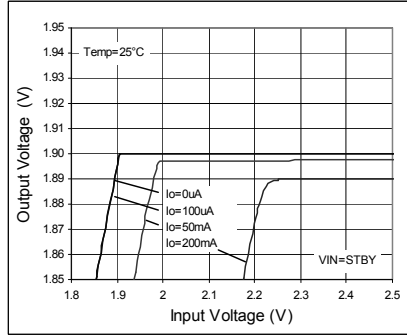

Fig.81. Line Regulation

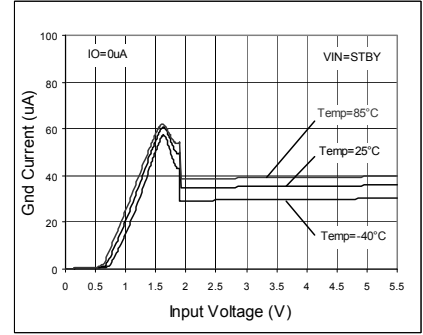

Fig.82. Circuit Current IGND

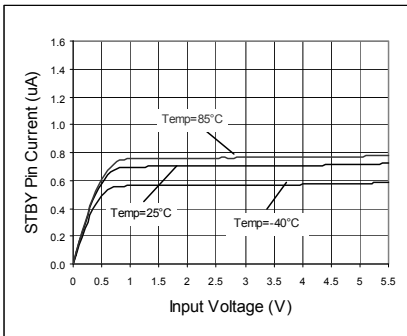

Fig.83. VSTBY - ISTBY

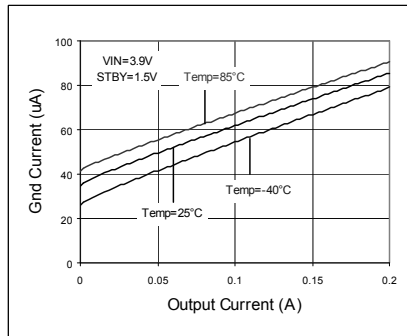

Fig.84. IOU - IGND

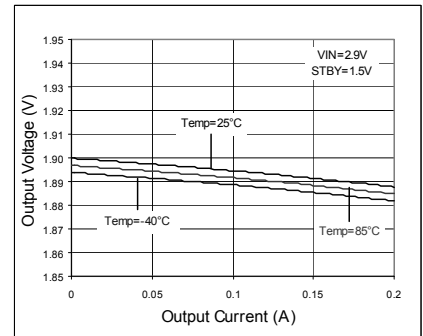

Fig.85. Load Regulation

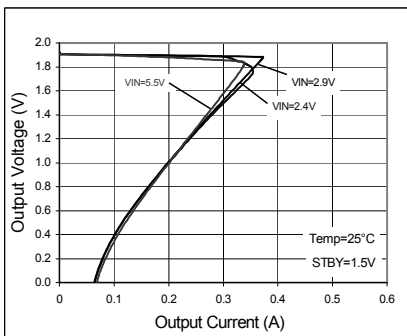

Fig.86. OCP Threshold

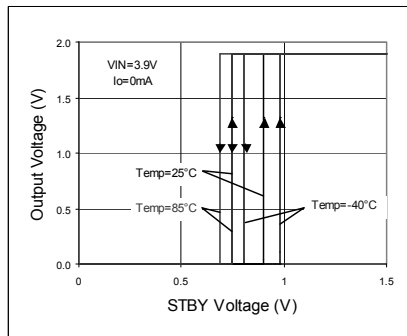

Fig.87. STBY Threshold

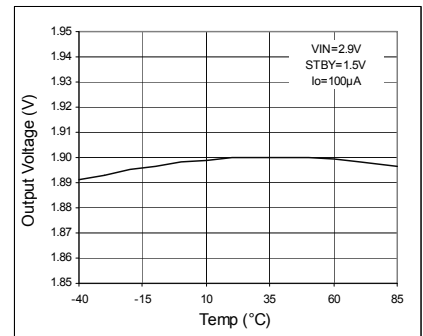

Fig.88. VOUT - Temp

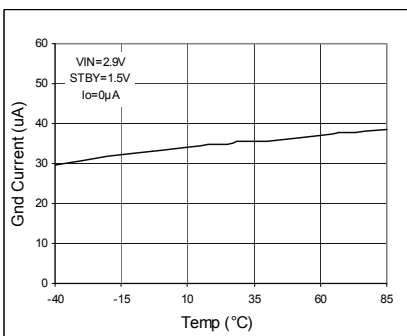

Fig.89. IGND - Temp

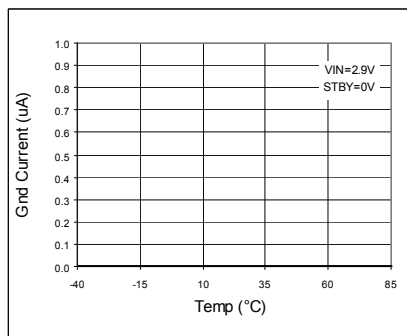

Fig.90. IGND - Temp (STBY)

●Reference data BU19TD2WNVX (Ta=25°C unless otherwise specified.)

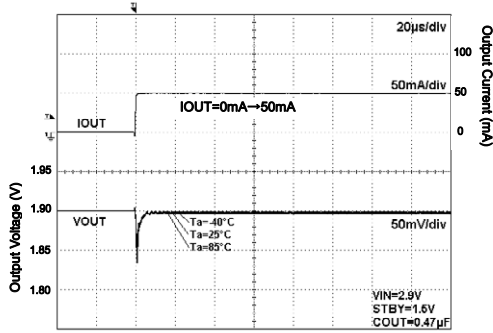

Fig.91. Load Response

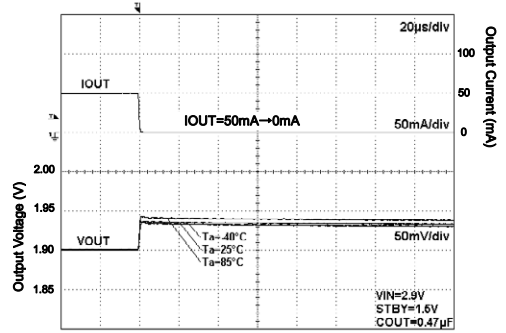

Fig.92. Load Response

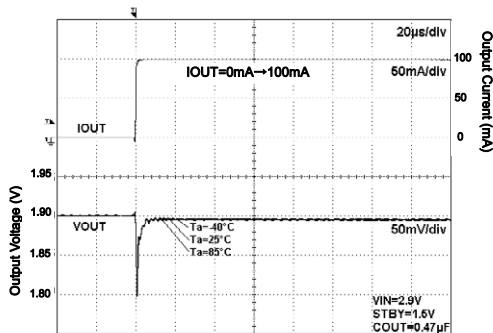

Fig.93. Load Response

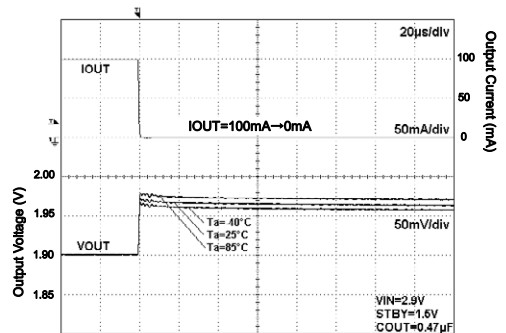

Fig.94. Load Response

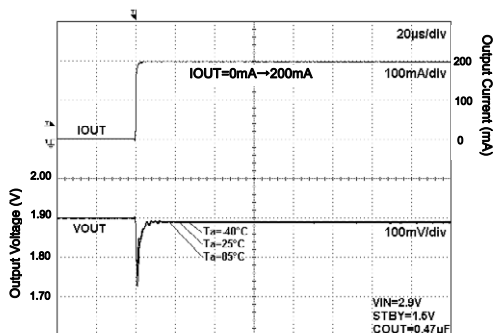

Fig.95. Load Response

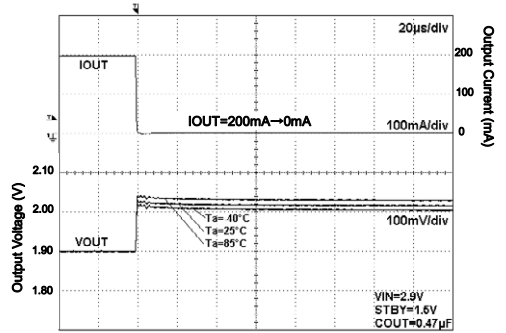

Fig.96. Load Response

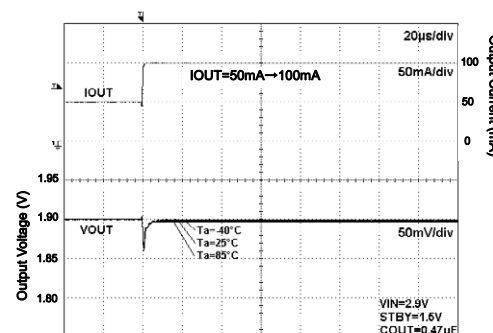

Fig.97. Load Response

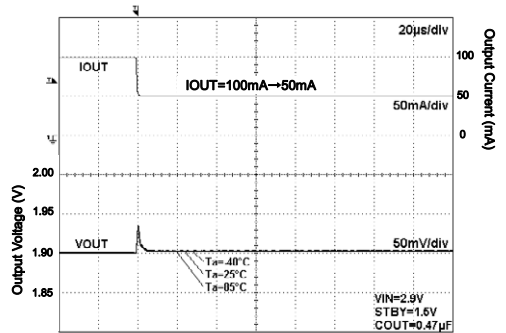

Fig.98. Load Response

●Reference data BU19TD2WNVX (Ta=25°C unless otherwise specified.)

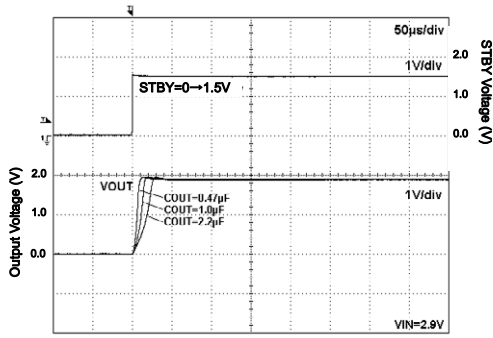

Fig.99. Start Up Time  
Iout=0mA

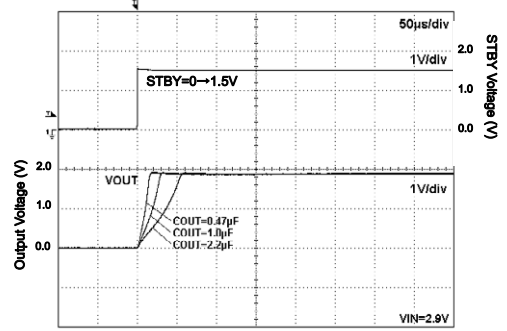

Fig.100. Start Up Time  
Iout=200mA

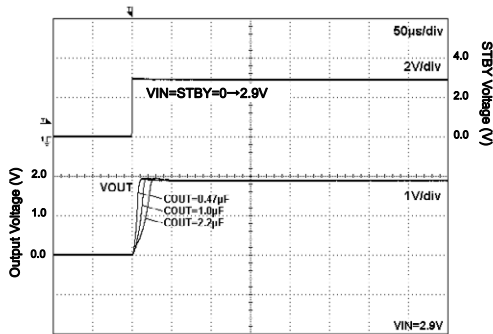

Fig.101. Start Up Time  
(VIN=STBY) Iout=0mA

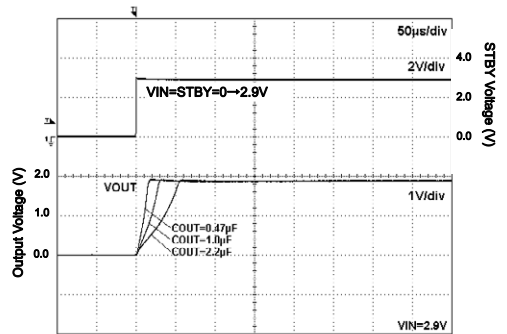

Fig.102. Start Up Time  
(VIN=STBY) Iout=200mA

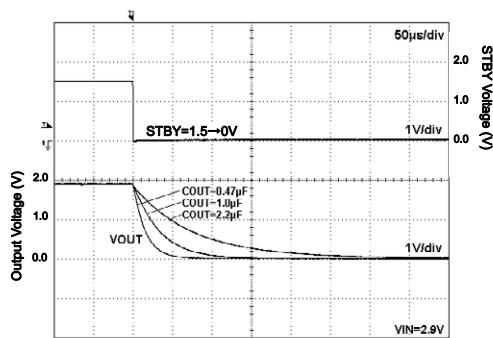

Fig.103. Discharge Time

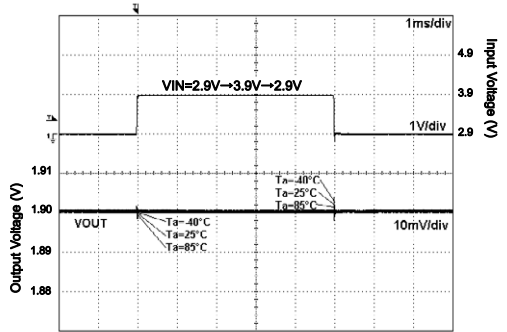

Fig.104. VIN Response



●Reference data BU25TD2WNVX (Ta=25°C unless otherwise specified.)

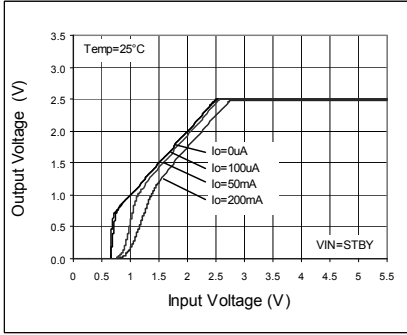

Fig.105. Output Voltage

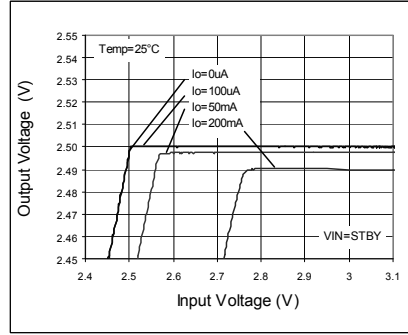

Fig.106. Line Regulation

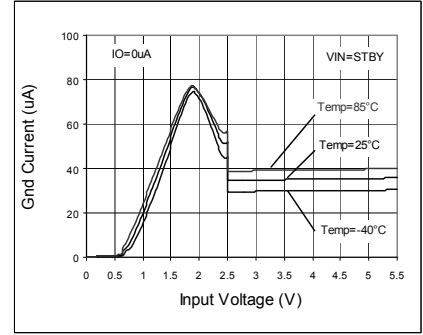

Fig.107. Circuit Current IGND

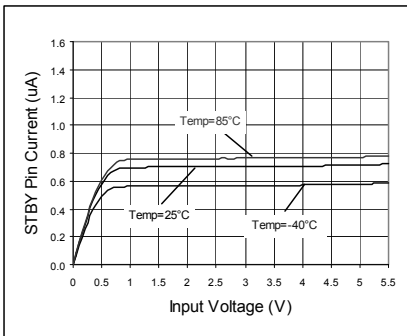

Fig.108. VSTBY - ISTBY

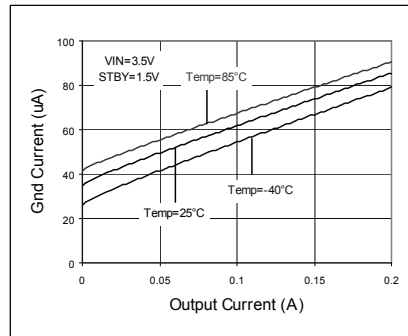

Fig.109. IOU - IGND

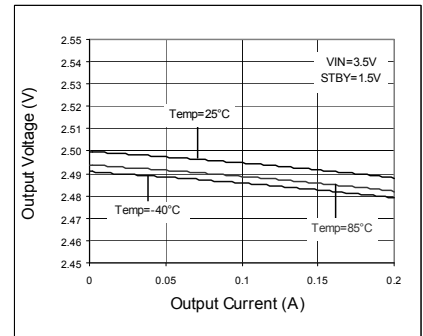

Fig.110. Load Regulation

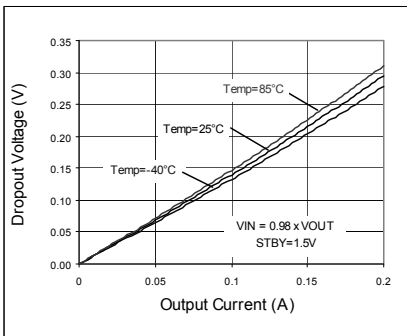

Fig.111. Dropout Voltage

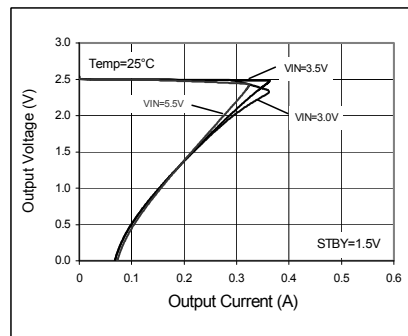

Fig.112. OCP Threshold

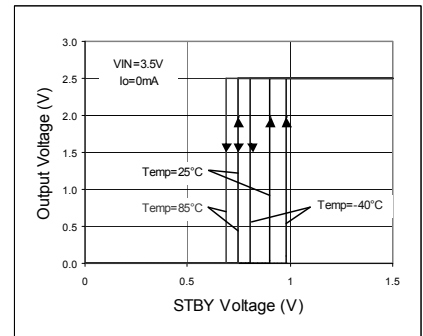

Fig.113. STBY Threshold

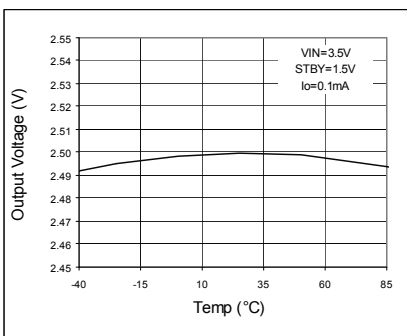

Fig.114. VOUT - Temp

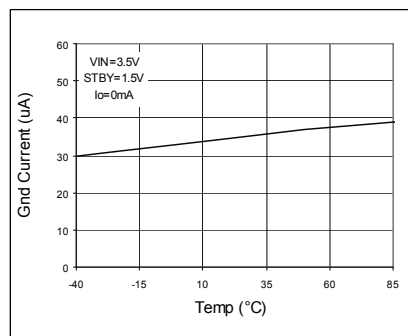

Fig.115. IGND - Temp

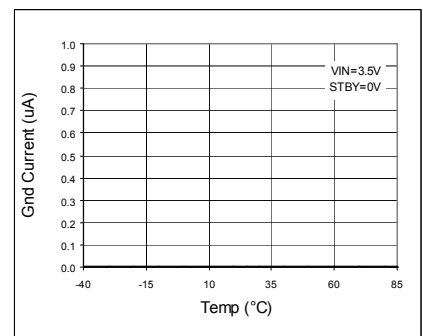

Fig.116. IGND - Temp (STBY)

●Reference data BU25TD2WNVX (Ta=25°C unless otherwise specified.)

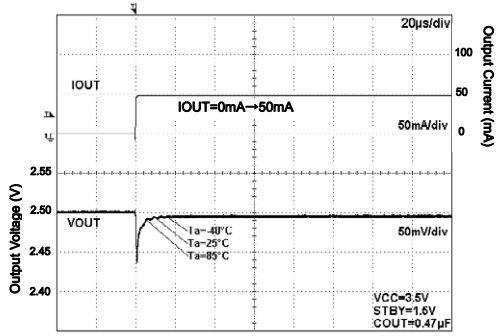

Fig.117. Load Response

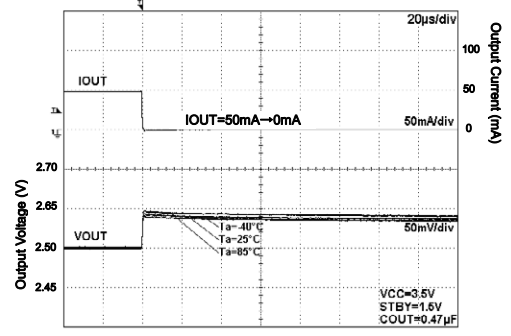

Fig.118. Load Response

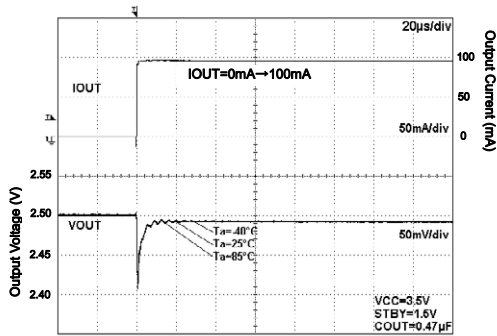

Fig.119. Load Response

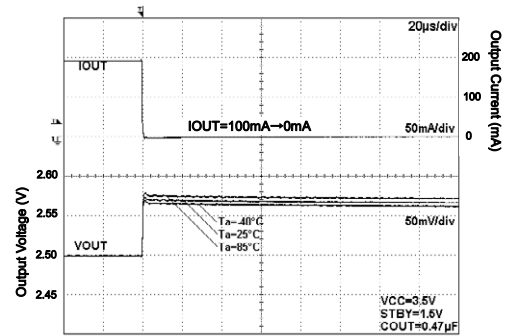

Fig.120. Load Response

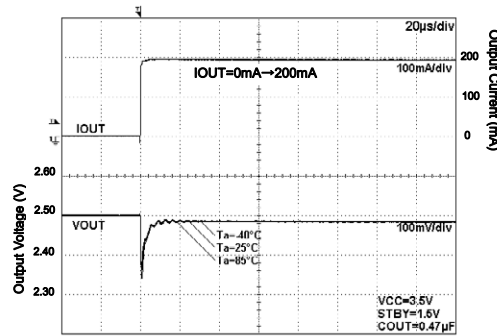

Fig.121. Load Response

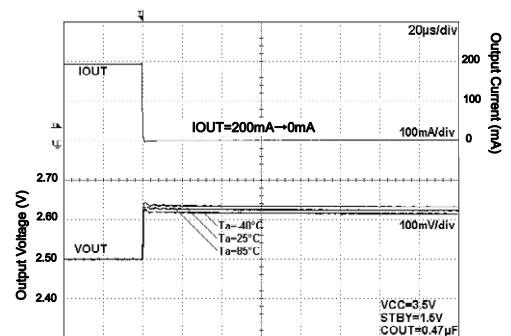

Fig.122. Load Response

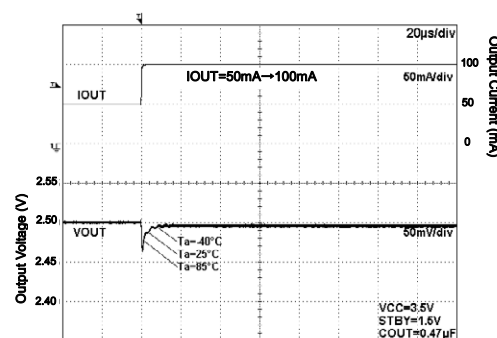

Fig.123. Load Response

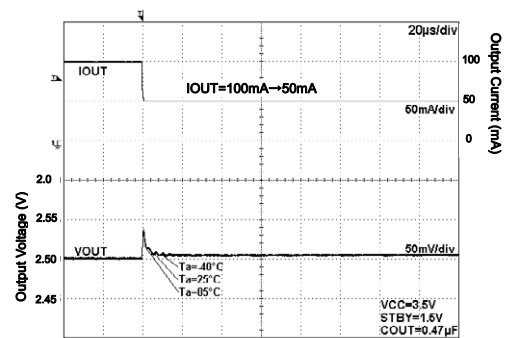

Fig.124. Load Response

●Reference data BU25TD2WNVX (Ta=25°C unless otherwise specified.)

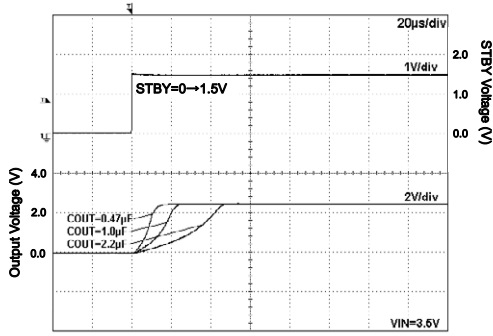

Fig.125. Start Up Time  
Iout=0mA

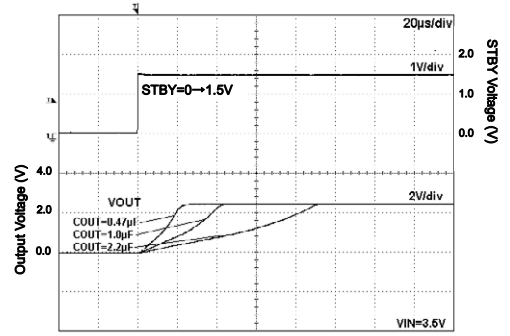

Fig.126. Start Up Time  
Iout=200mA

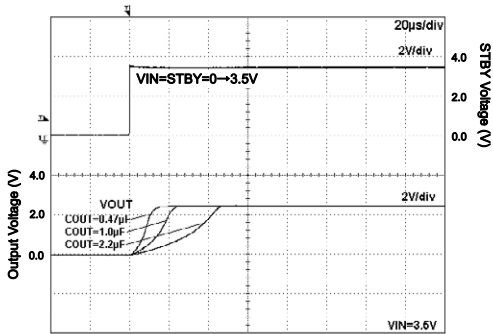

Fig.127. Start Up Time  
(VIN=STBY) Iout=0mA

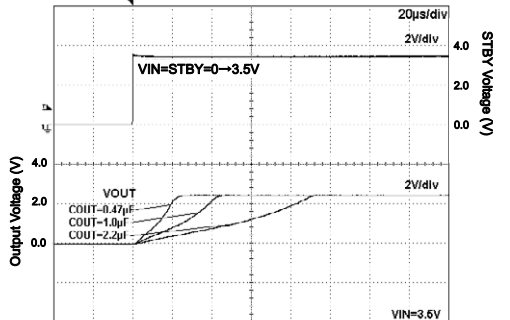

Fig.128. Start Up Time  
(VIN=STBY) Iout=200mA

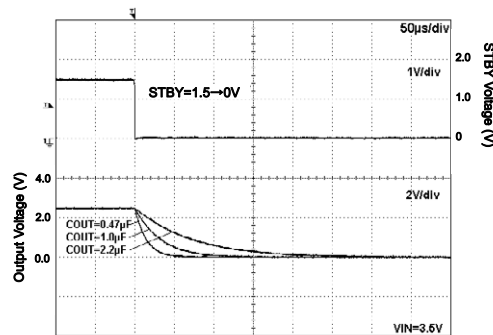

Fig.129. Discharge Time

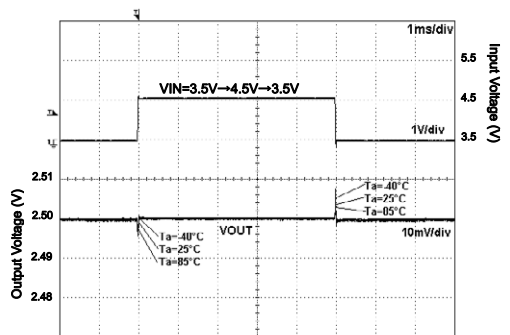

Fig.130. VIN Response

●Reference data BU26TD2WNVX (Ta=25°C unless otherwise specified.)

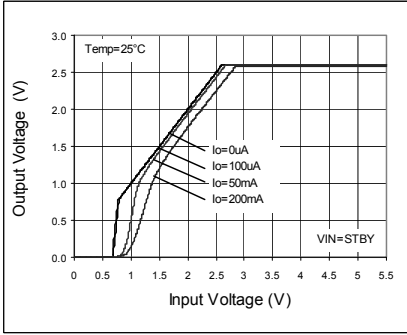

Fig.131. Output Voltage

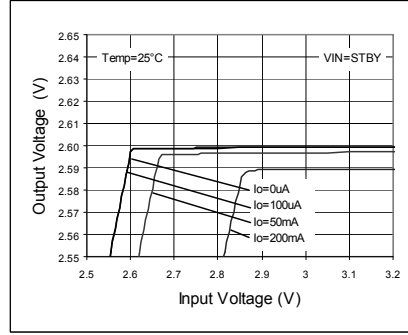

Fig.132. Line Regulation

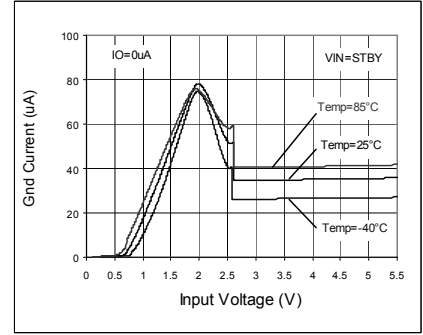

Fig.133. Circuit Current IGND

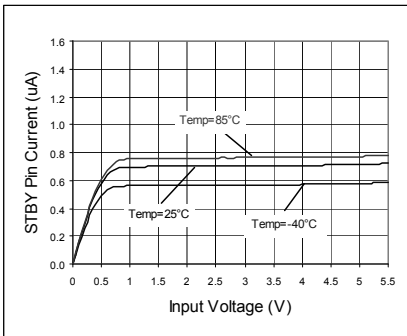

Fig.134. VSTBY - ISTBY

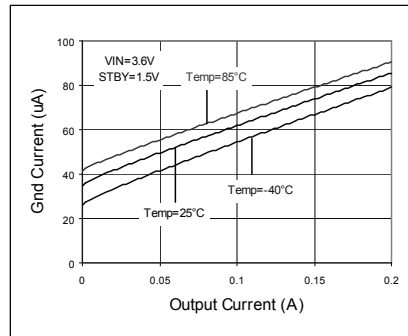

Fig.135. IOUT - IGDND

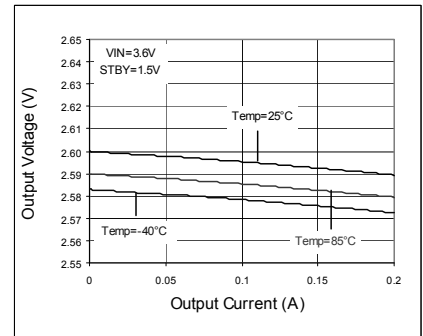

Fig.136. Load Regulation

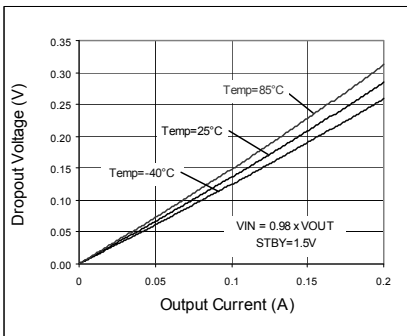

Fig.137. Dropout Voltage

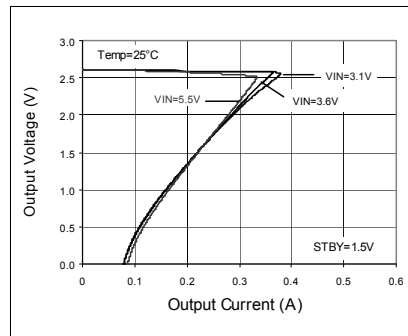

Fig.138. OCP Threshold

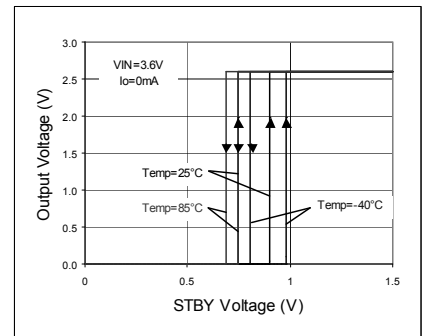

Fig.139. STBY Threshold

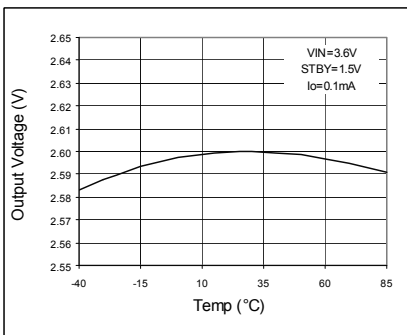

Fig.140. VOUT - Temp

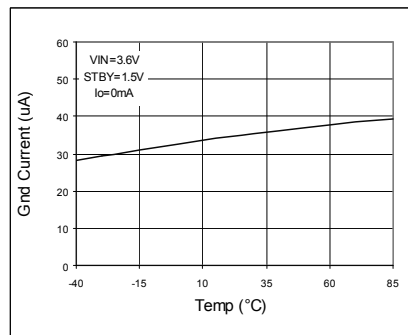

Fig.141. IGDND - Temp

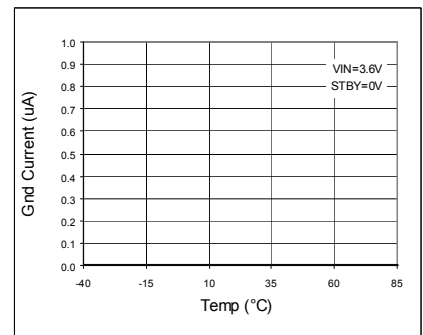

Fig.142. IGDND - Temp (STBY)

●Reference data BU26TD2WNVX (Ta=25°C unless otherwise specified.)

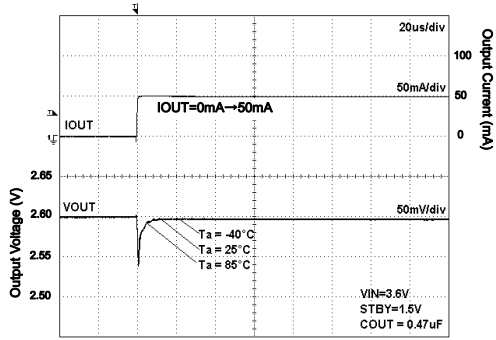

Fig. 143. Load Response

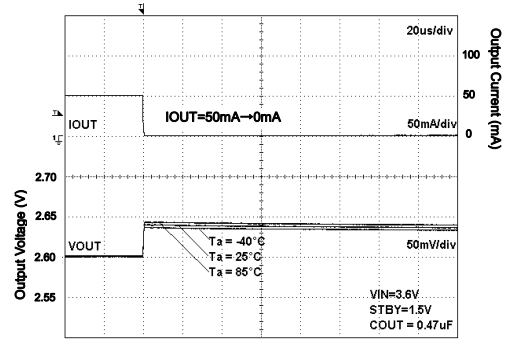

Fig. 144. Load Response

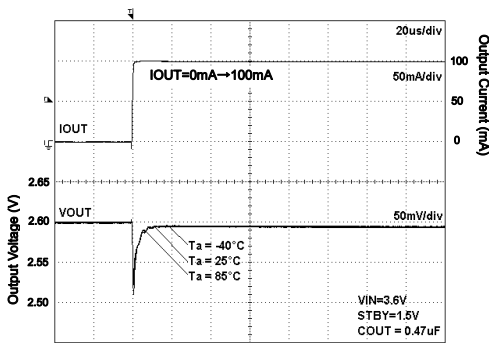

Fig. 145. Load Response

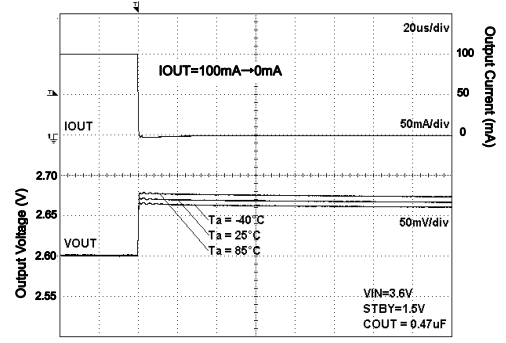

Fig. 146. Load Response

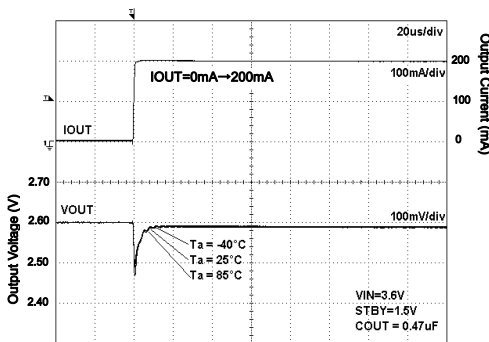

Fig. 147. Load Response

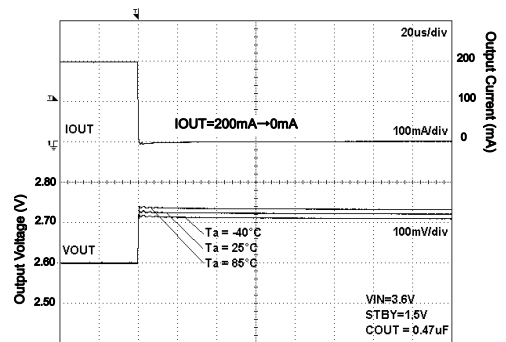

Fig. 148. Load Response

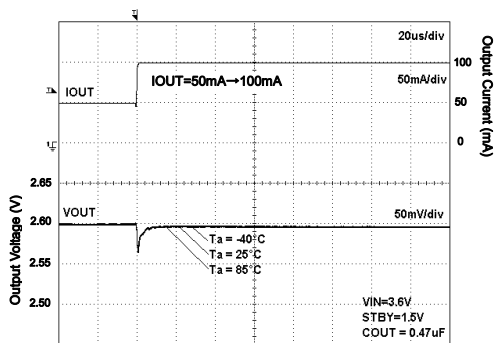

Fig. 149. Load Response

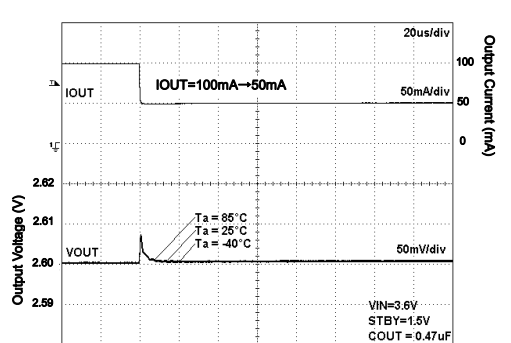

Fig. 150. Load Response

●Reference data BU26TD2WNVX (Ta=25°C unless otherwise specified.)

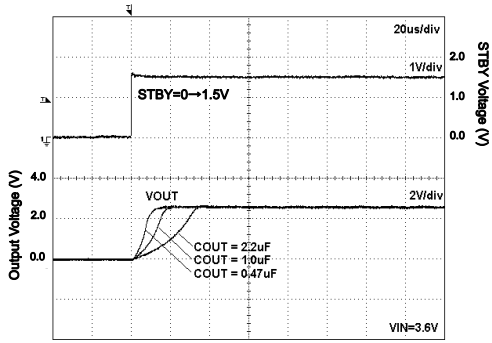

Fig.151. Start Up Time  
Iout=0mA

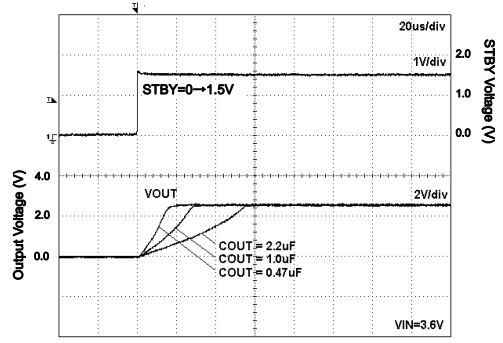

Fig.152. Start Up Time  
Iout=200mA

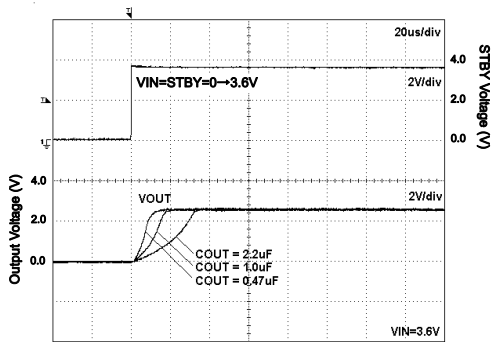

Fig.153. Start Up Time  
(VIN=STBY) Iout=0mA

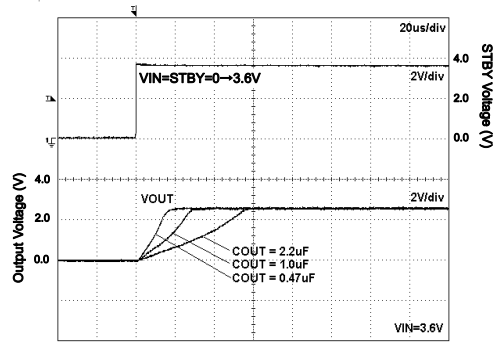

Fig.154. Start Up Time  
(VIN=STBY) Iout=200mA

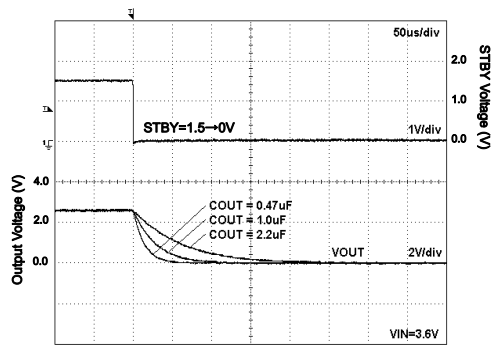

Fig.155. Discharge Time

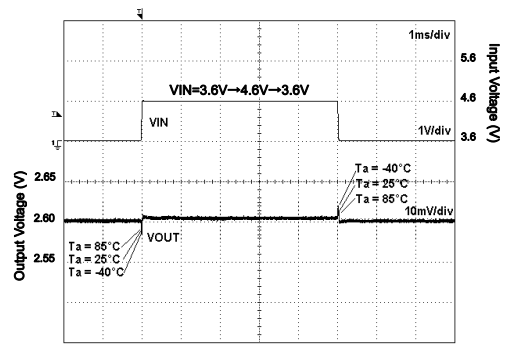

Fig.156. VIN Response

●Reference data BU27TD2WNVX (Ta=25°C unless otherwise specified.)

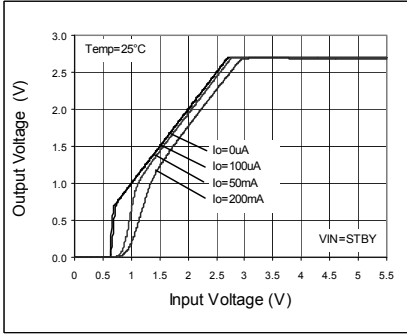

Fig.157. Output Voltage

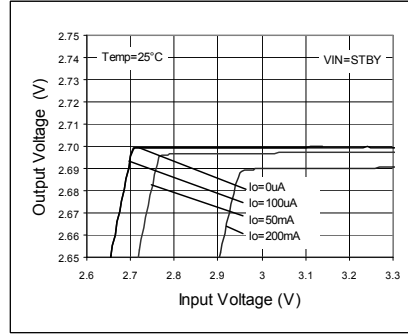

Fig.158. Line Regulation

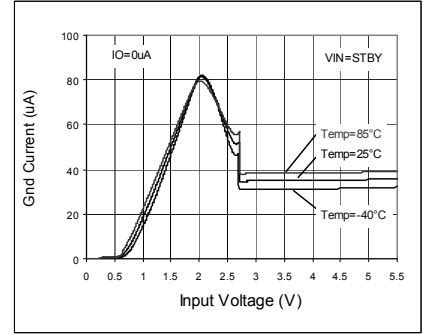

Fig.159. Circuit Current IGND

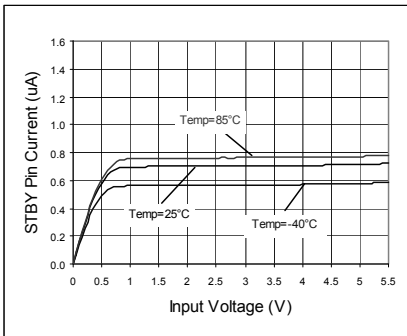

Fig.160. VSTBY - ISTBY

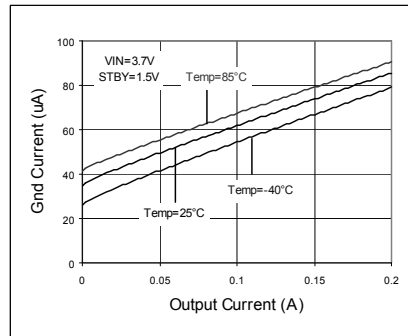

Fig.161. IOOUT - IGND

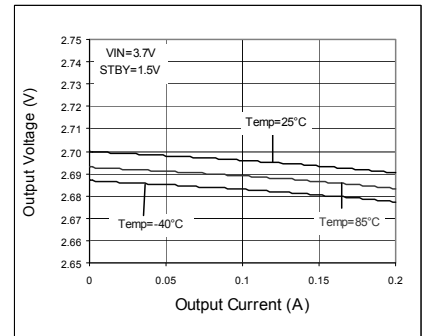

Fig.162. Load Regulation

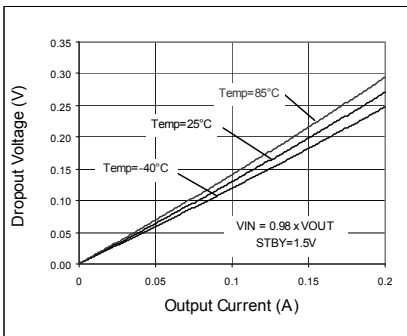

Fig.163. Dropout Voltage

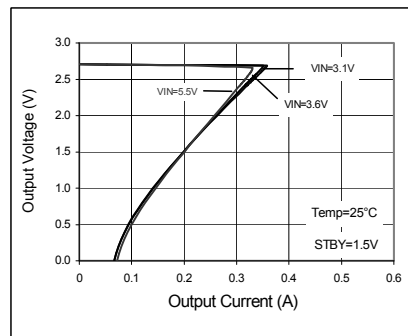

Fig.164. OCP Threshold

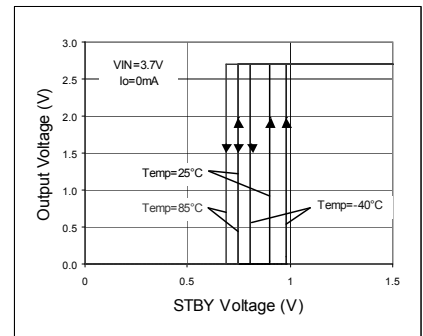

Fig.165. STBY Threshold

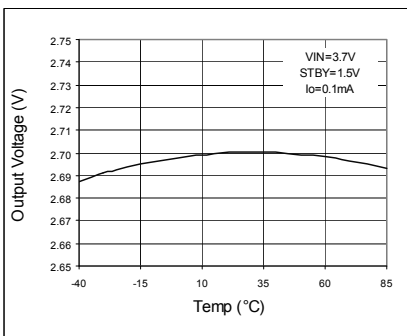

Fig.166. VOUT - Temp

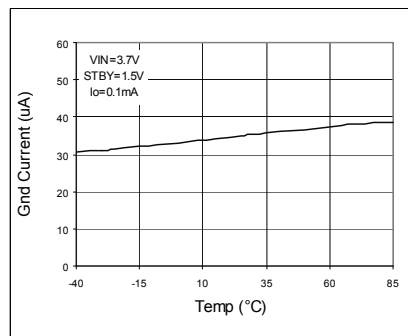

Fig.167. IGND - Temp

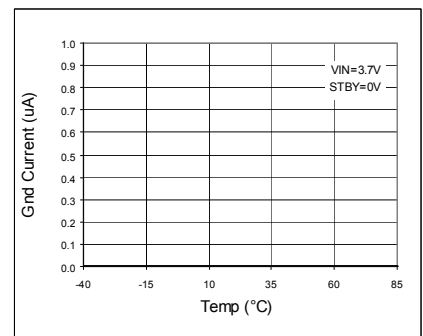

Fig.168. IGND - Temp (STBY)

●Reference data BU27TD2WNVX (Ta=25°C unless otherwise specified.)

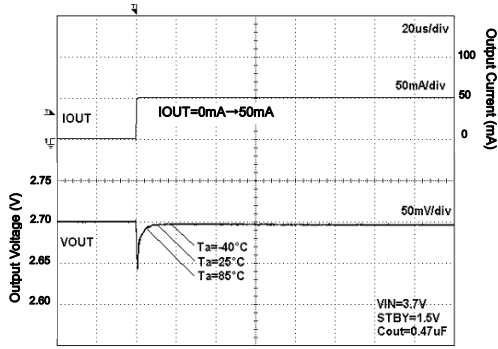

Fig.169. Load Response

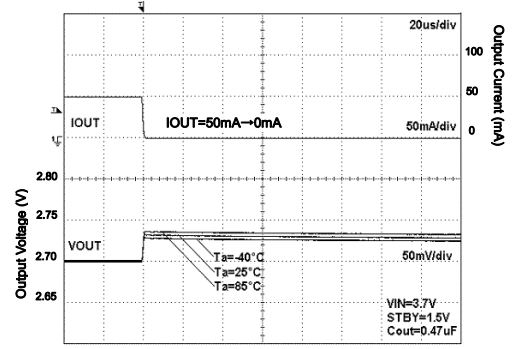

Fig.170. Load Response

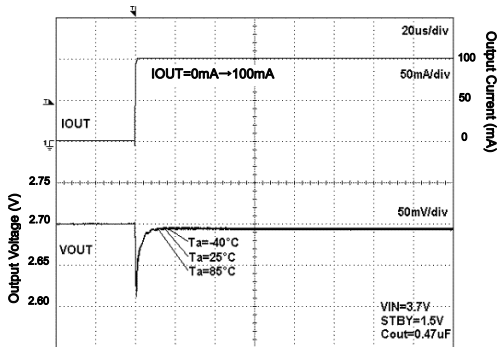

Fig.171. Load Response

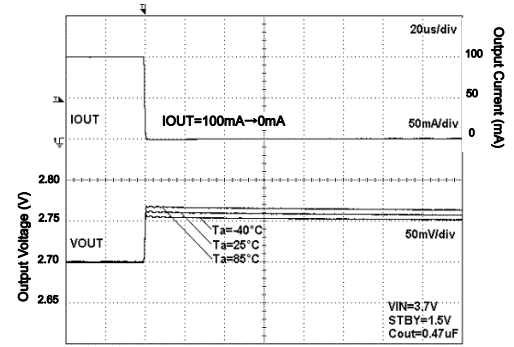

Fig.172. Load Response

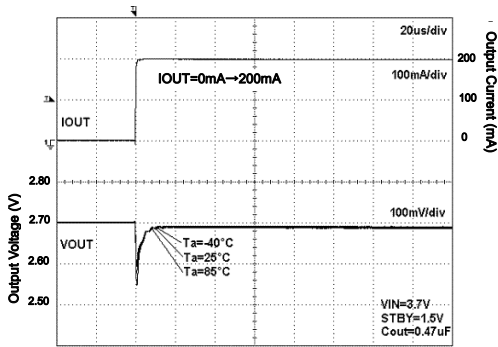

Fig.173. Load Response

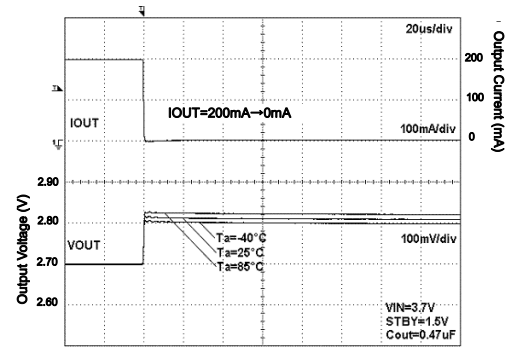

Fig.174. Load Response

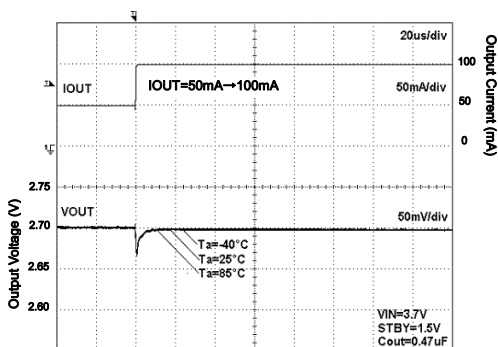

Fig.175. Load Response

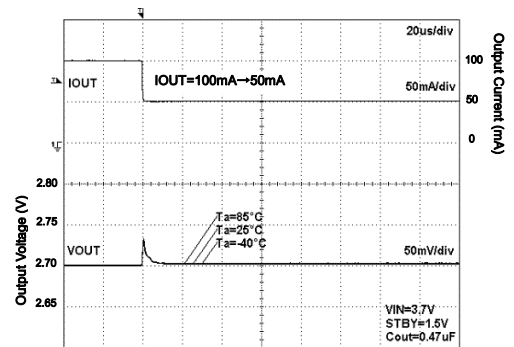

Fig.176. Load Response



●Reference data BU27TD2WNVX (Ta=25°C unless otherwise specified.)

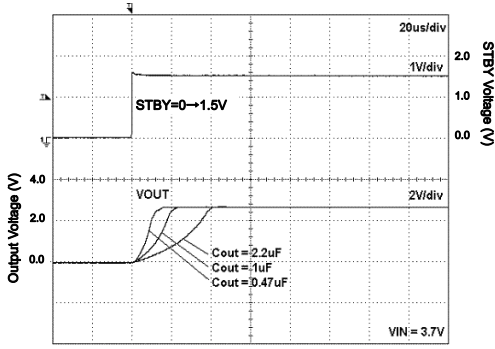

Fig.177. Start Up Time  
Iout=0mA

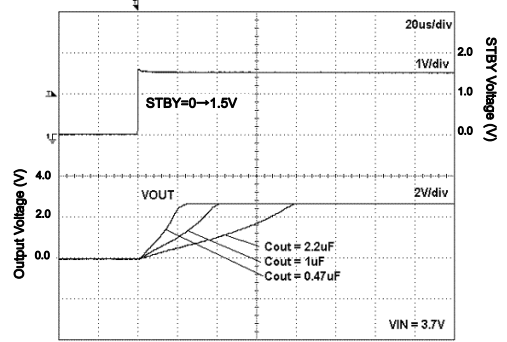

Fig.178. Start Up Time  
Iout=200mA

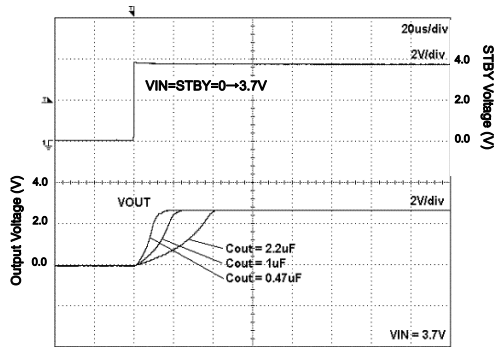

Fig.179. Start Up Time  
(VIN=STBY) Iout=0mA

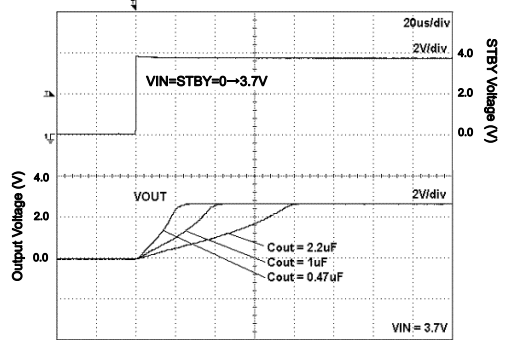

Fig.180. Start Up Time  
(VIN=STBY) Iout=200mA

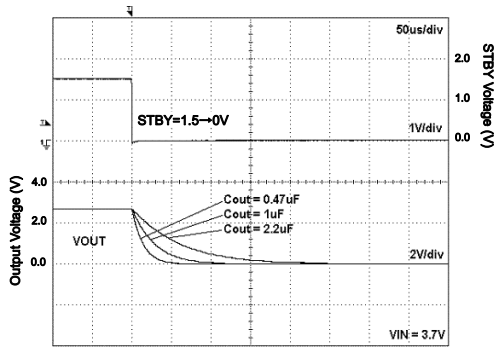

Fig.181. Discharge Time

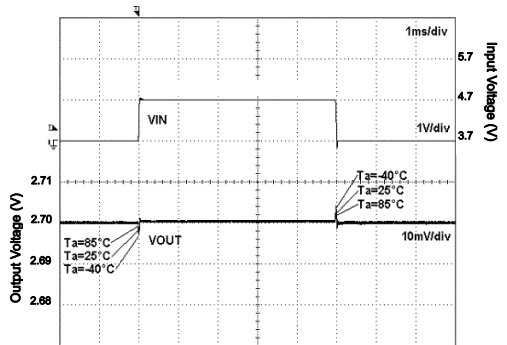

Fig.182. VIN Response

●Reference data BU28TD2WNVX (Ta=25°C unless otherwise specified.)

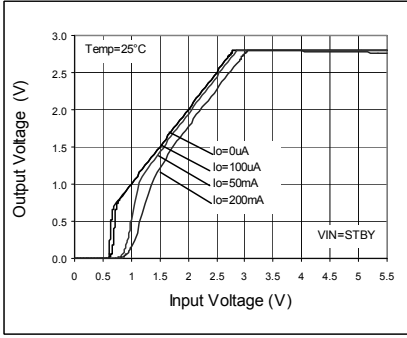

Fig. 183. Output Voltage

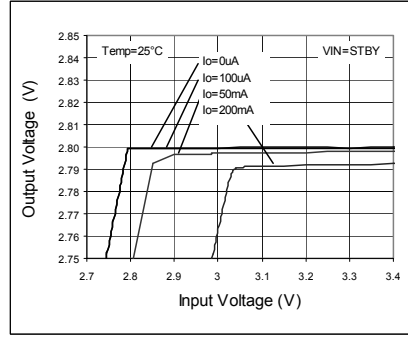

Fig. 184. Line Regulation

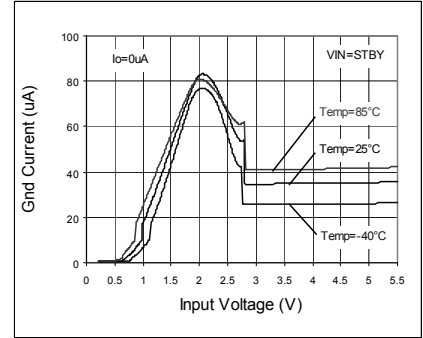

Fig. 185. Circuit Current IGND

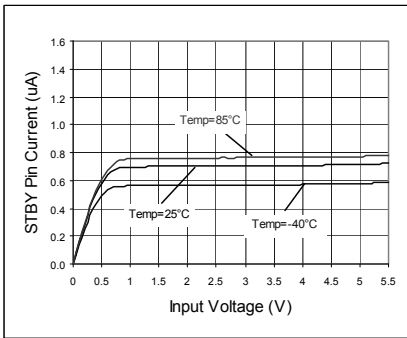

Fig. 186. VSTBY - ISTBY

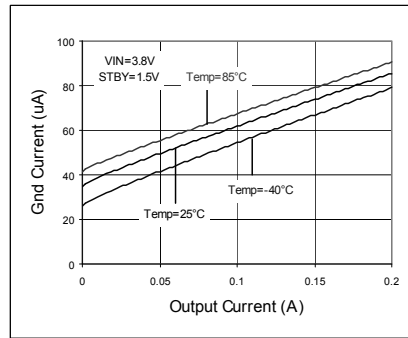

Fig. 187. IOUT - IIGND

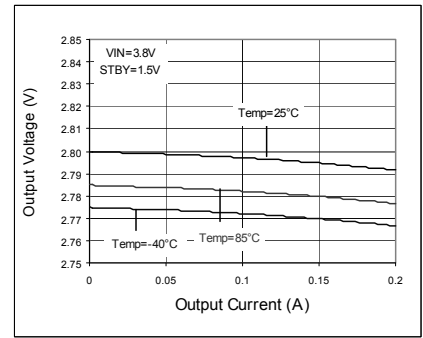

Fig. 188. Load Regulation

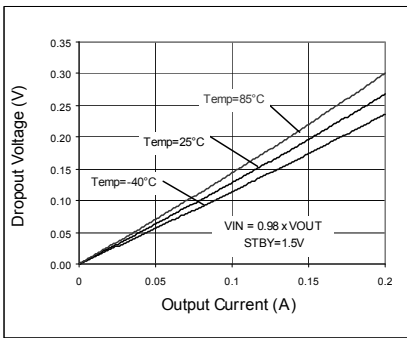

Fig. 189. Dropout Voltage

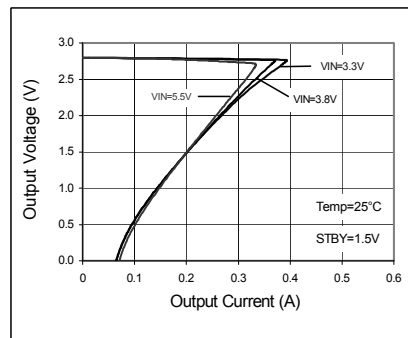

Fig. 190. OCP Threshold

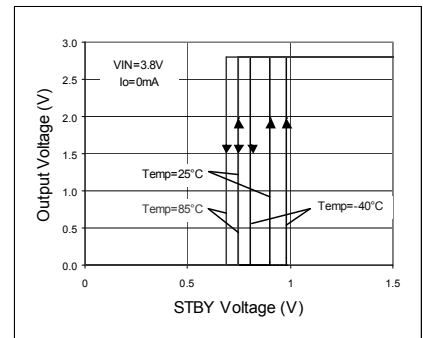

Fig. 191. STBY Threshold

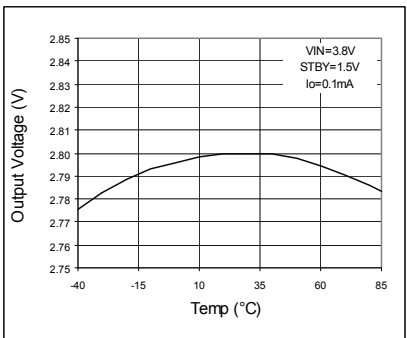

Fig. 192. VOUT - Temp

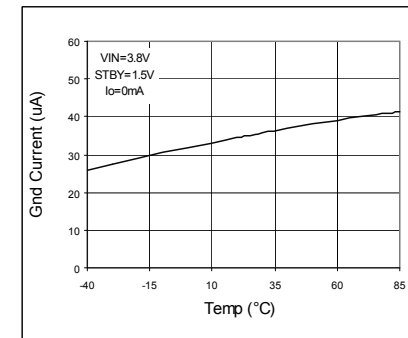

Fig. 193. IIGND - Temp

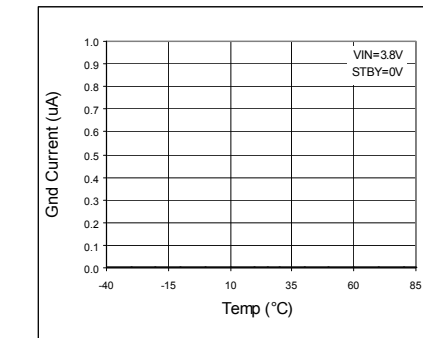

Fig. 194. IIGND - Temp (STBY)

●Reference data BU28TD2WNVX (Ta=25°C unless otherwise specified.)

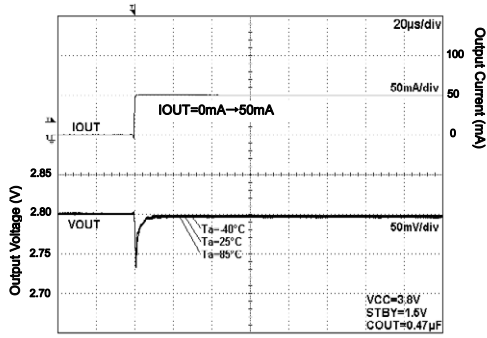

Fig.195. Load Response

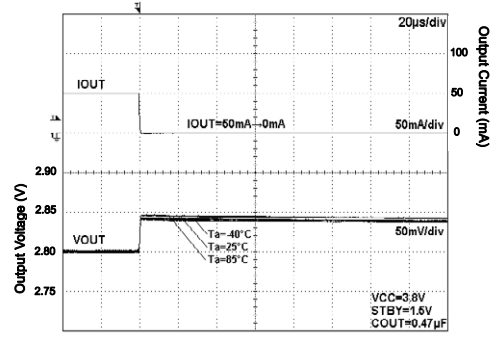

Fig.196. Load Response

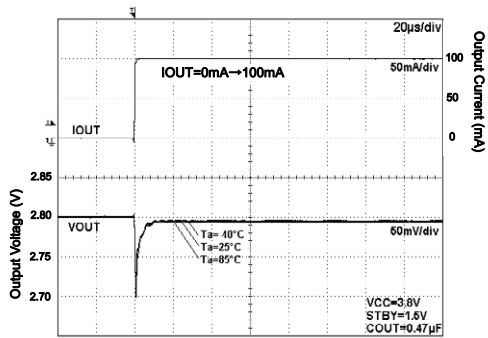

Fig.197. Load Response

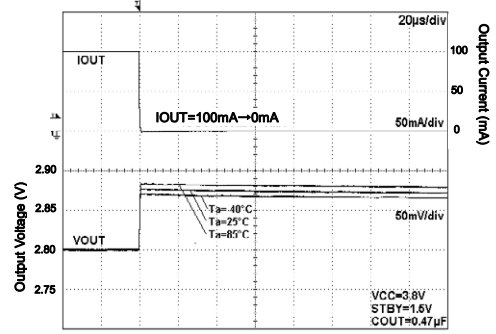

Fig.198. Load Response

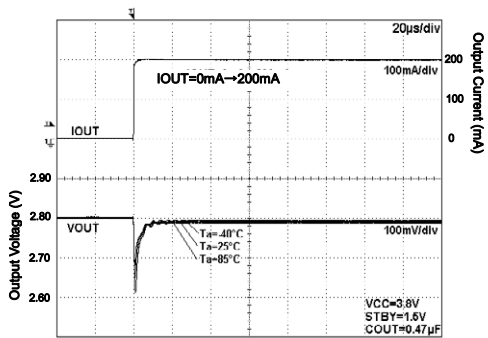

Fig.199. Load Response

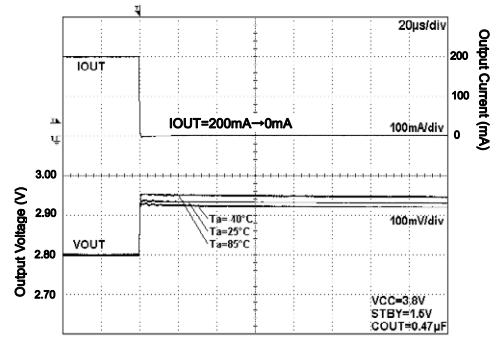

Fig.200. Load Response

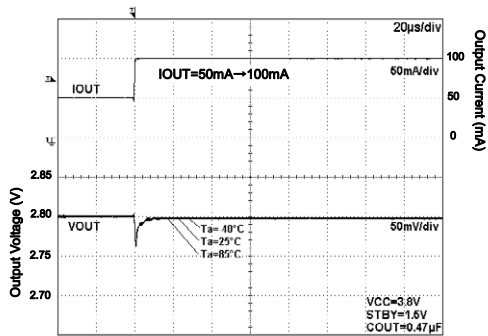

Fig.201. Load Response

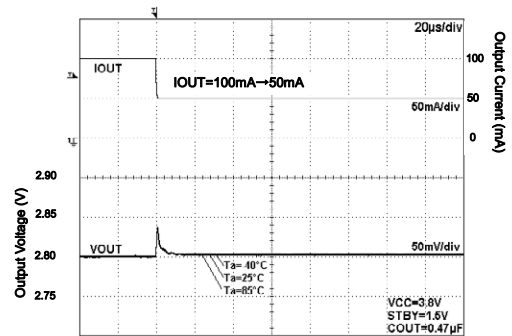

Fig.202. Load Response

●Reference data BU28TD2WNVX (Ta=25°C unless otherwise specified.)

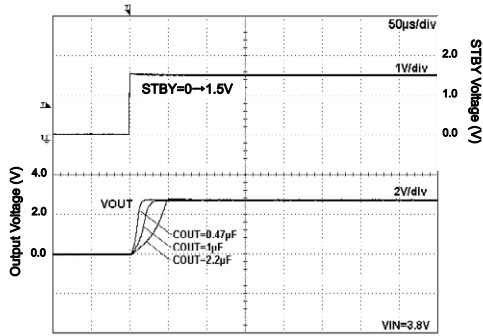

Fig.203. Start Up Time  
Iout=0mA

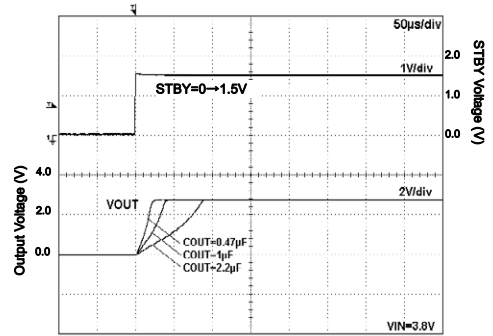

Fig.204. Start Up Time  
Iout=200mA

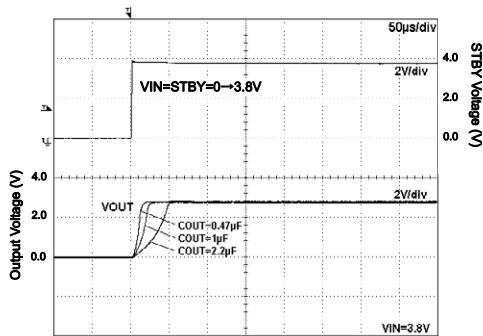

Fig.205. Start Up Time  
(VIN=STBY) Iout=0mA

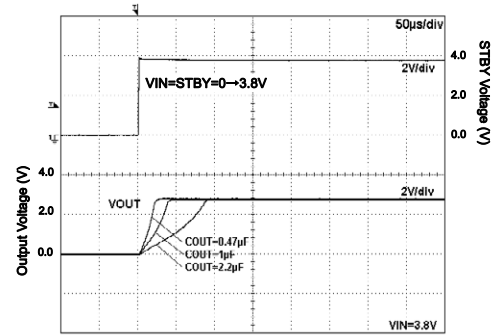

Fig.206. Start Up Time  
(VIN=STBY) Iout=200mA

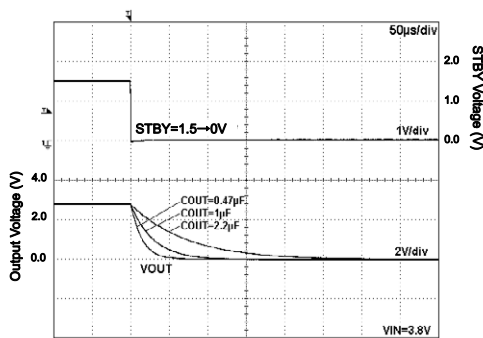

Fig.207. Discharge Time

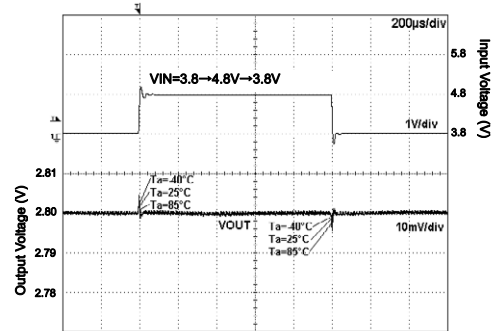

Fig.208. VIN Response

●Reference data BU30TD2WNVX (Ta=25°C unless otherwise specified.)

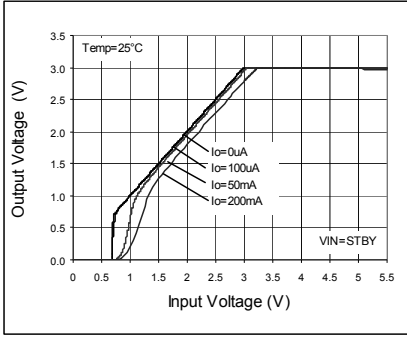

Fig.209. Output Voltage

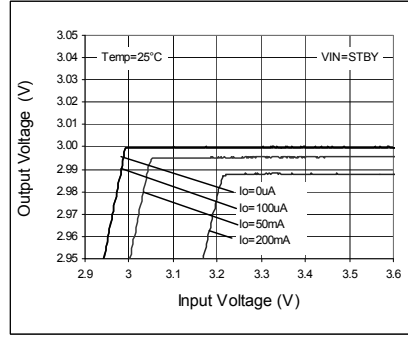

Fig.210. Line Regulation

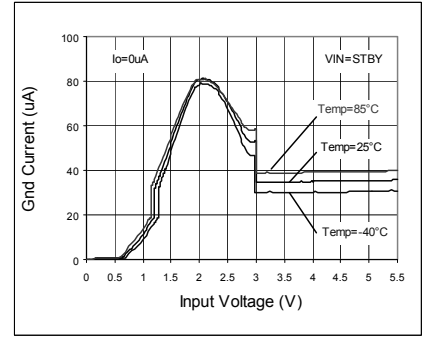

Fig.211. Circuit Current IGND

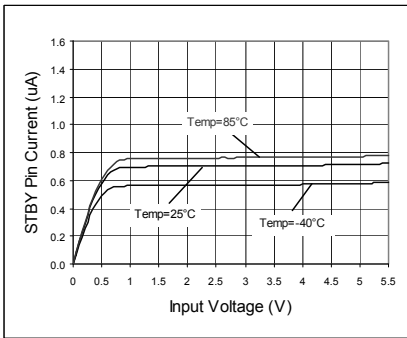

Fig.212. VSTBY - ISTBY

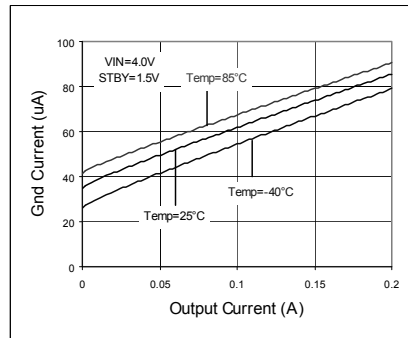

Fig.213. IOUT - IGND

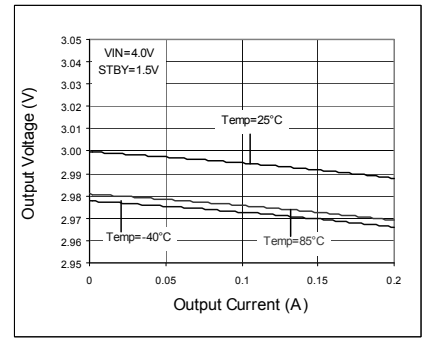

Fig.214. Load Regulation

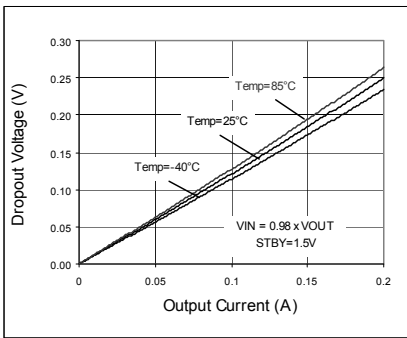

Fig.215. Dropout Voltage

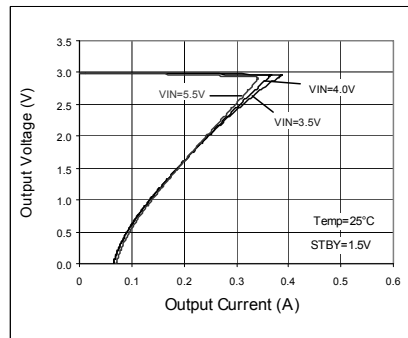

Fig.216. OCP Threshold

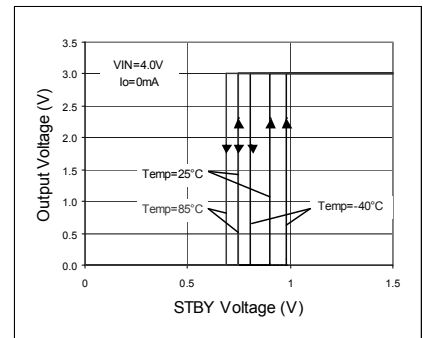

Fig.217. STBY Threshold

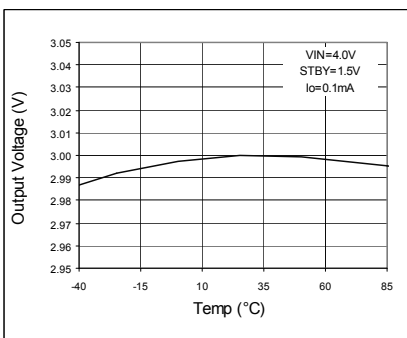

Fig.218. VOUT - Temp

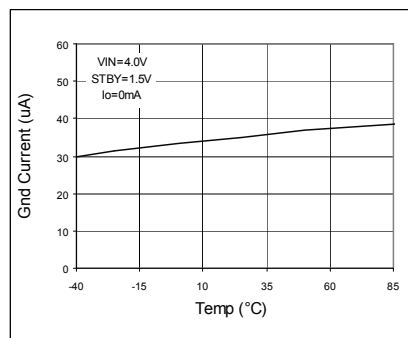

Fig.219. IGND - Temp

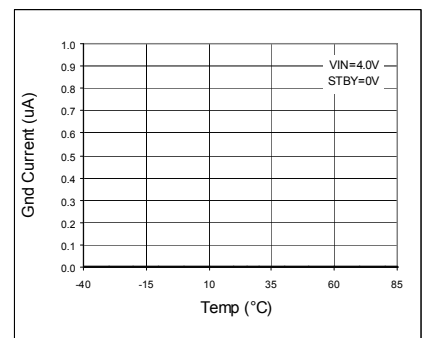

Fig.220. IGND - Temp (STBY)

●Reference data BU30TD2WNVX (Ta=25°C unless otherwise specified.)

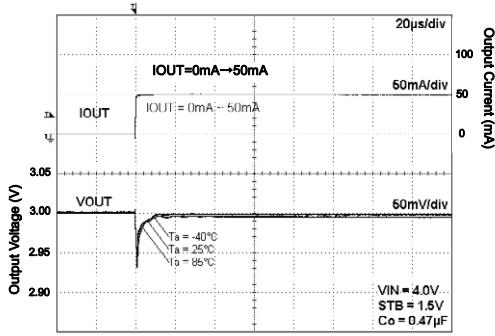

Fig.221. Load Response

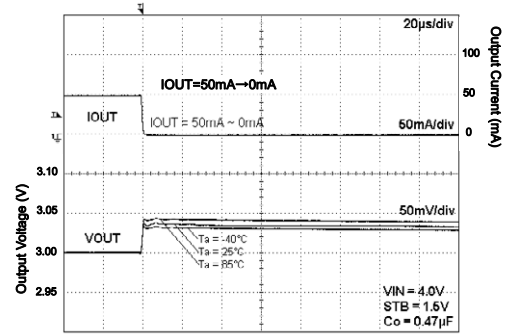

Fig.222. Load Response

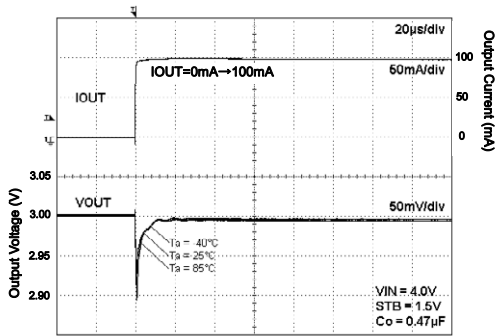

Fig.223. Load Response

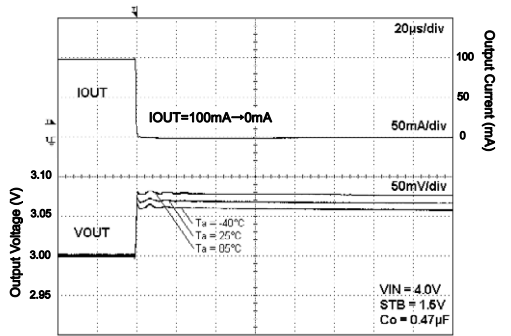

Fig.224. Load Response

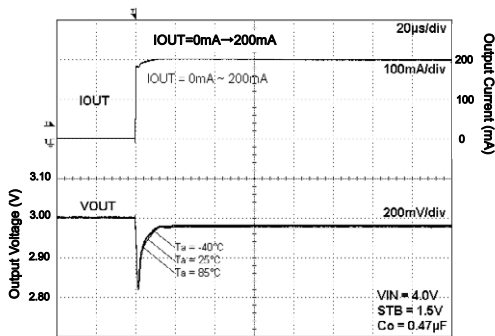

Fig.225. Load Response

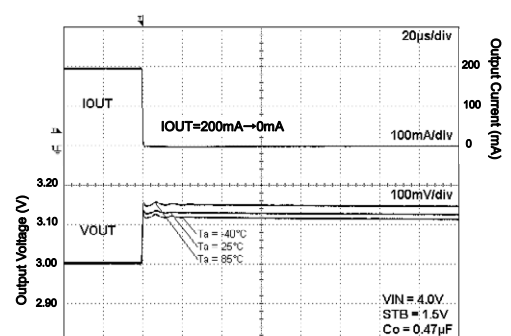

Fig.226. Load Response

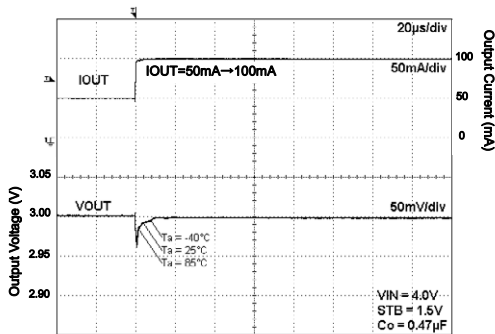

Fig.227. Load Response

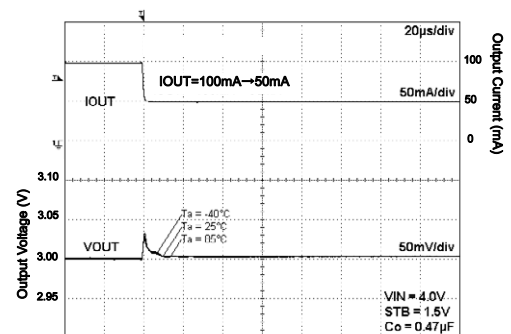

Fig.228. Load Response

●Reference data BU30TD2WNVX (Ta=25°C unless otherwise specified.)

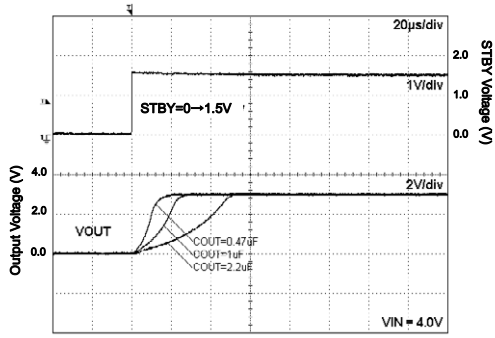

Fig.229. Start Up Time  
Iout=0mA

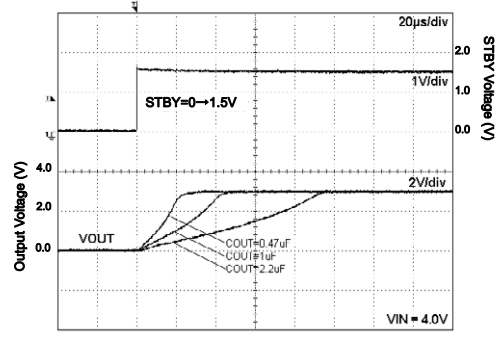

Fig.230. Start Up Time  
Iout=200mA

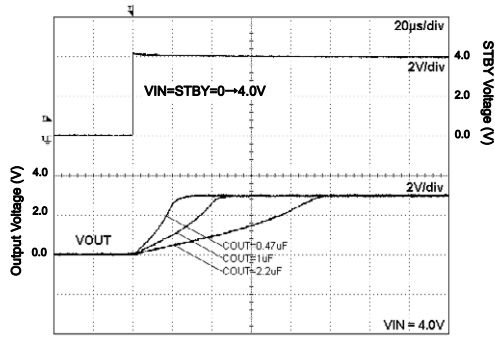

Fig.231. Start Up Time  
(VIN=STBY) Iout=0mA

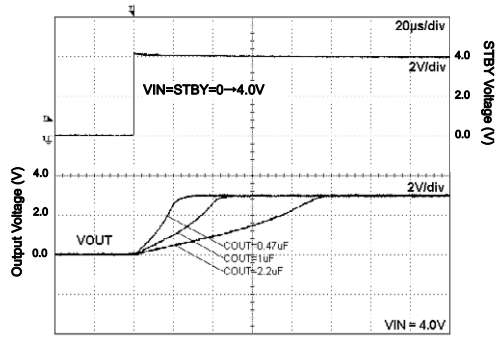

Fig.232. Start Up Time  
(VIN=STBY) Iout=200mA

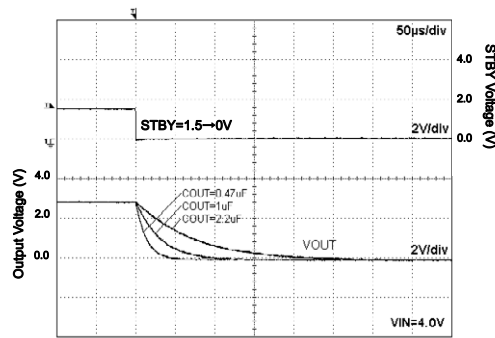

Fig.233. Discharge Time

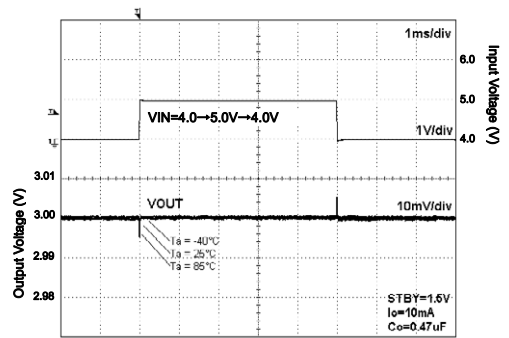

Fig.234. VIN Response

●Reference data BU31TD2WNVX (Ta=25°C unless otherwise specified.)

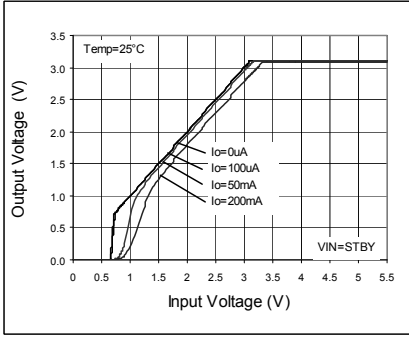

Fig.235. Output Voltage

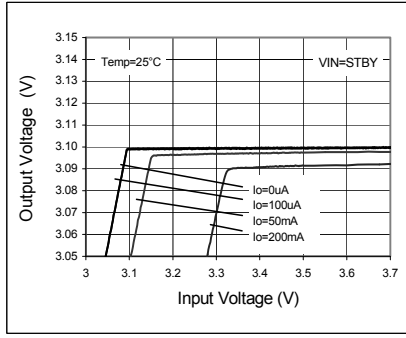

Fig.236. Line Regulation

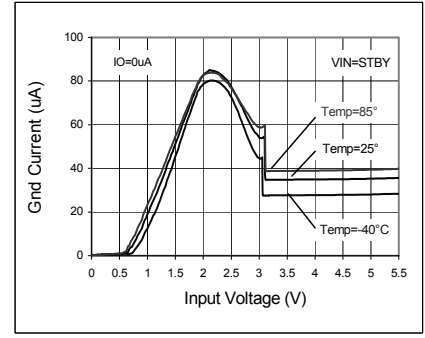

Fig.237. Circuit Current IGND

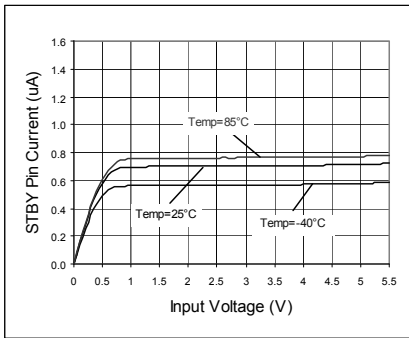

Fig.238. VSTBY - ISTBY

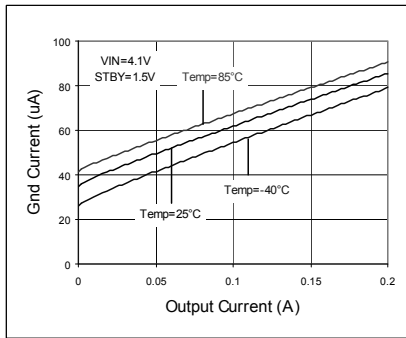

Fig.239. IOUT - IGND

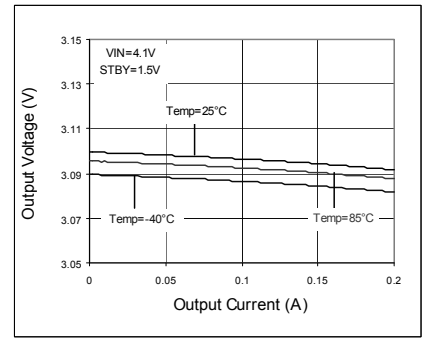

Fig.240. Load Regulation

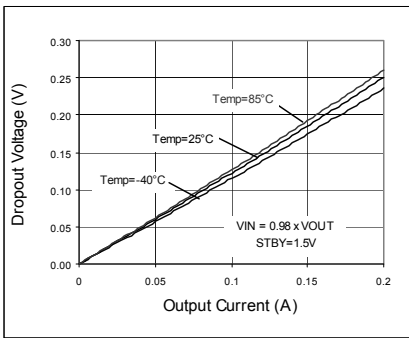

Fig.241. Dropout Voltage

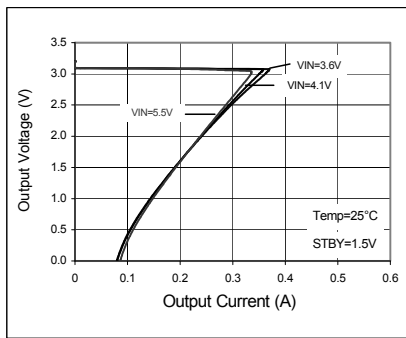

Fig.242. OCP Threshold

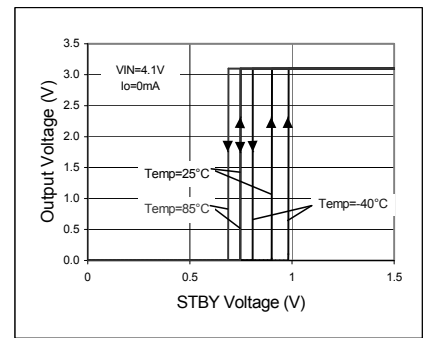

Fig.243. STBY Threshold

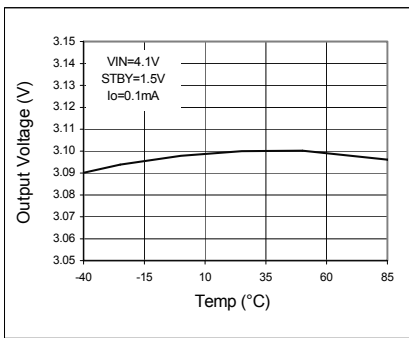

Fig.244. VOUT - Temp

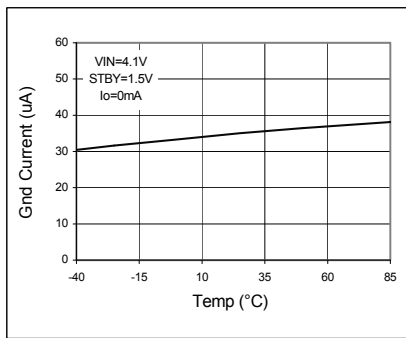

Fig.245. IGND - Temp

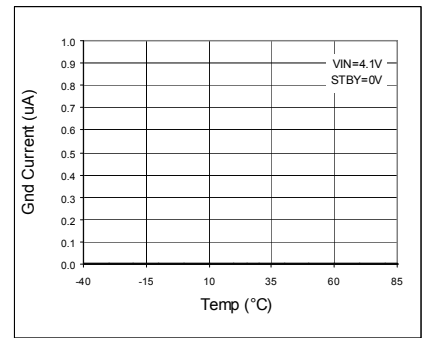

Fig.246. IGND - Temp (STBY)



●Reference data BU31TD2WNVX (Ta=25°C unless otherwise specified.)

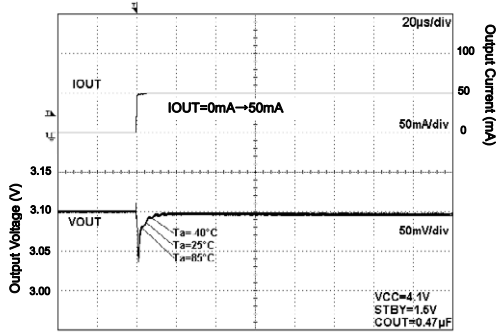

Fig.247. Load Response

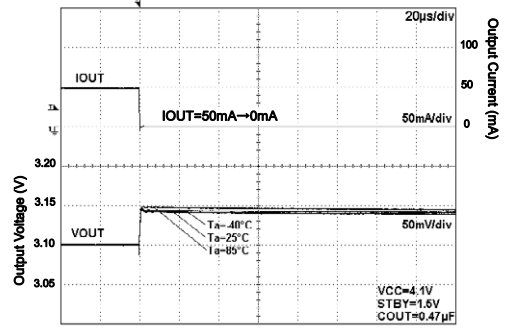

Fig.248. Load Response

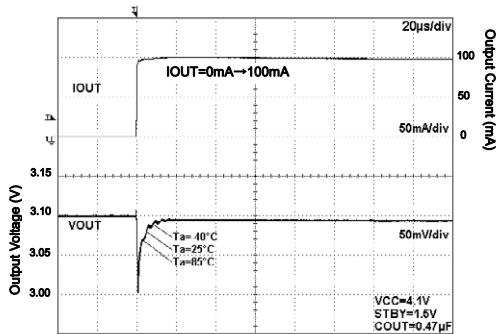

Fig.249. Load Response

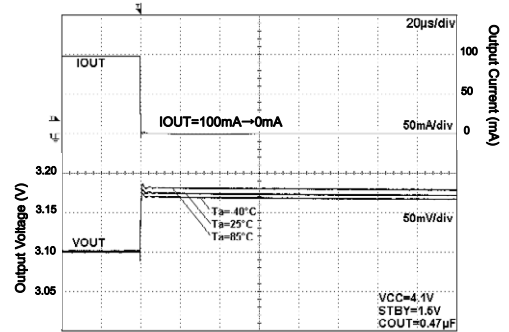

Fig.250. Load Response

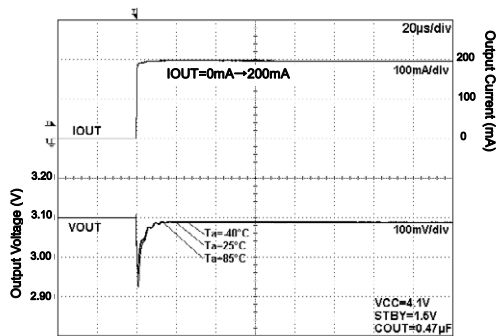

Fig.251. Load Response

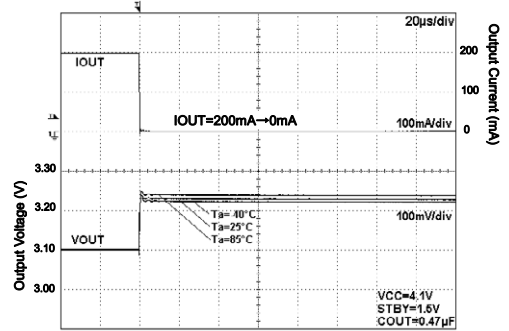

Fig.252. Load Response

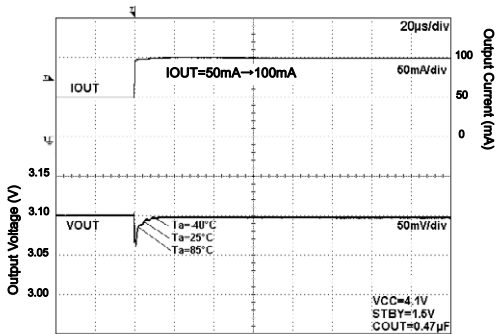

Fig.253. Load Response

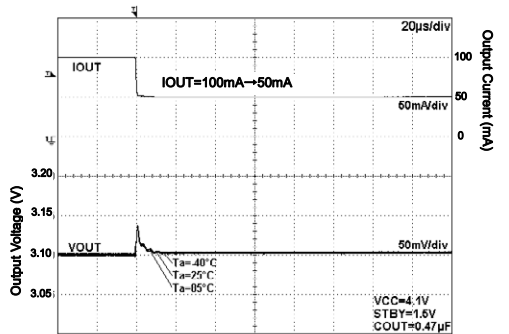

Fig.254. Load Response

●Reference data BU31TD2WNVX (Ta=25°C unless otherwise specified.)

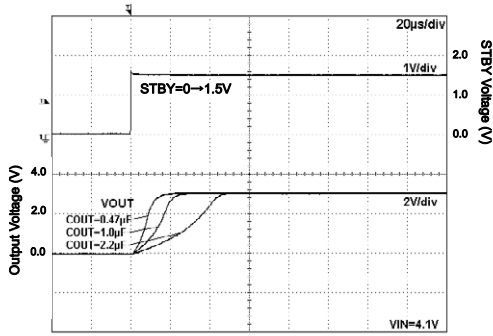

Fig.255. Start Up Time  
Iout=0mA

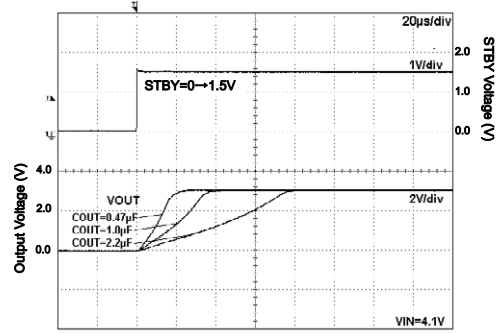

Fig.256. Start Up Time  
Iout=200mA

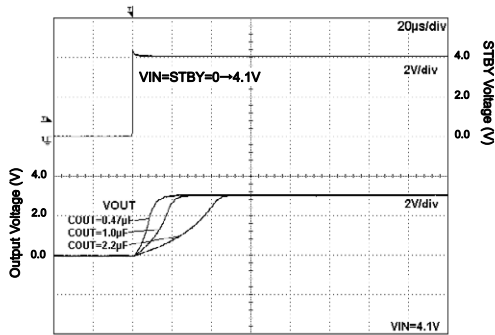

Fig.257. Start Up Time  
(VIN=STBY) Iout=0mA

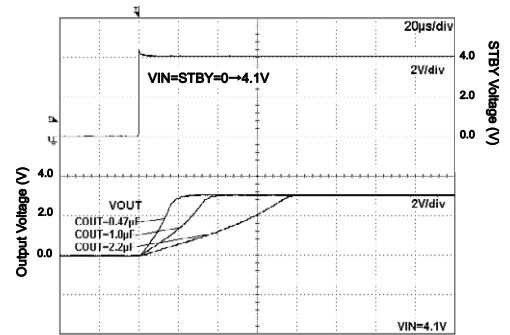

Fig.258. Start Up Time  
(VIN=STBY) Iout=200mA

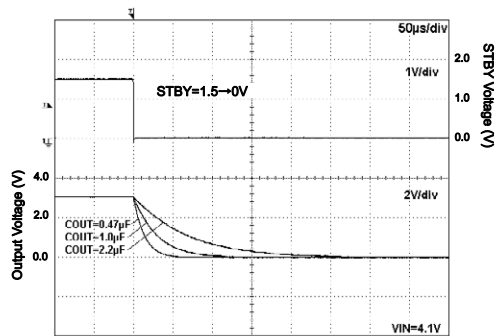

Fig.259. Discharge Time

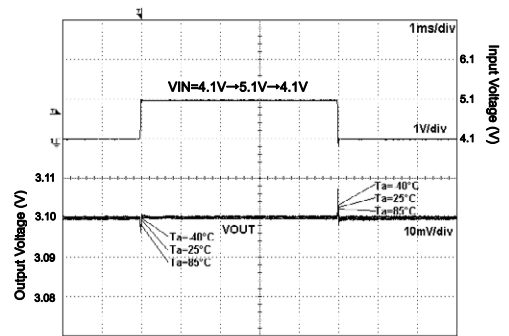

Fig.260. VIN Response

●Reference data BU33TD2WNVX (Ta=25°C unless otherwise specified.)

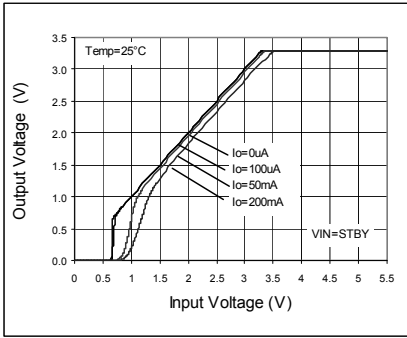

Fig.261. Output Voltage

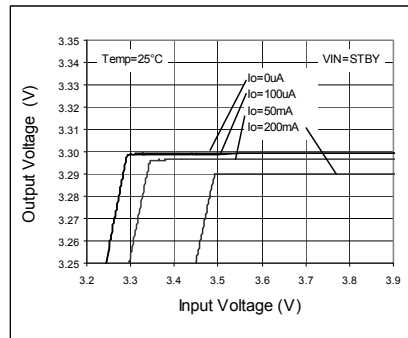

Fig.262. Line Regulation

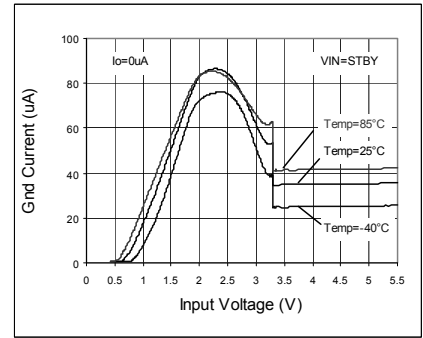

Fig.263. Circuit Current IGND

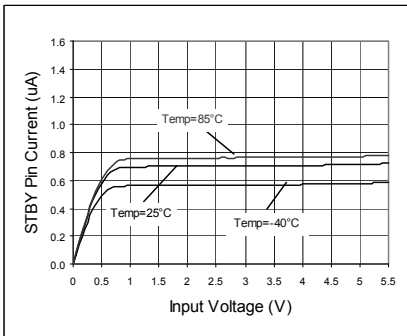

Fig.264. VSTBY - ISTBY

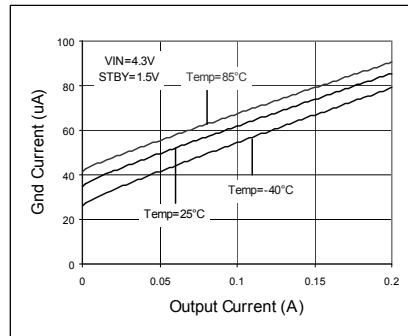

Fig.265. IOUT - IGND

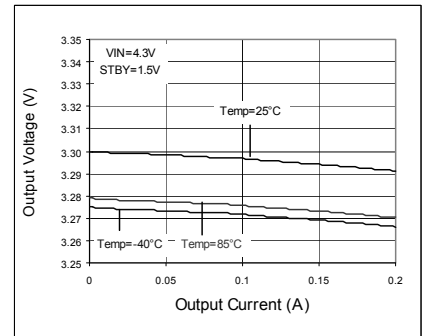

Fig.266. Load Regulation

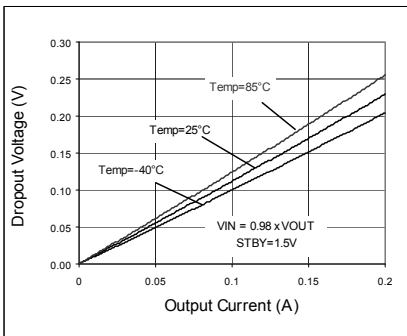

Fig.267. Dropout Voltage

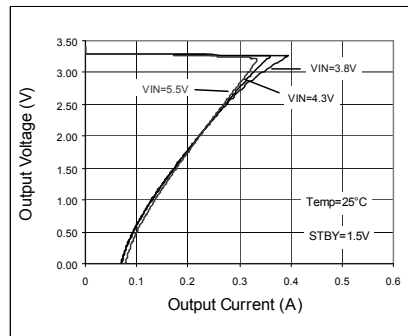

Fig.268. OCP Threshold

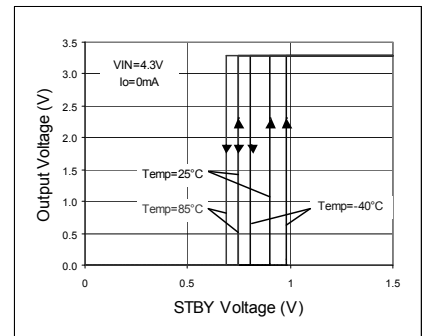

Fig.269. STBY Threshold

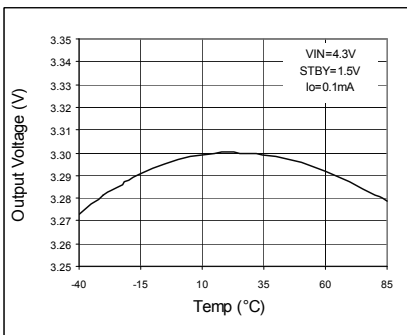

Fig.270. VOUT - Temp

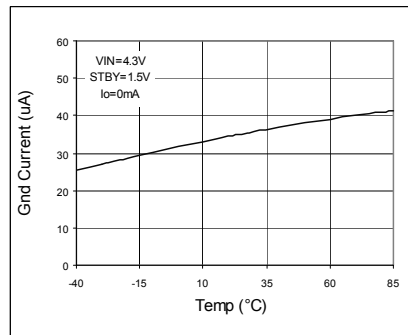

Fig.271. IGND - Temp

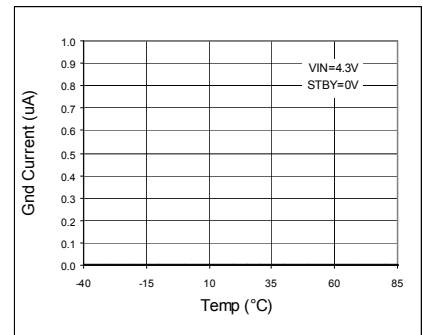

Fig.272. IGND - Temp (STBY)

●Reference data BU33TD2WNVX (Ta=25°C unless otherwise specified.)

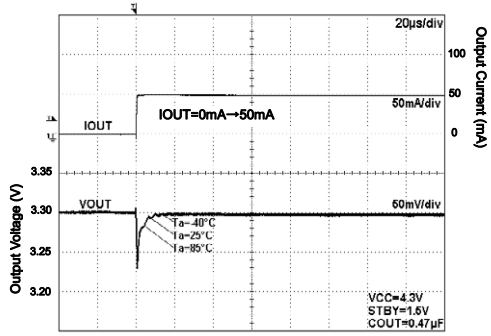

Fig.273. Load Response

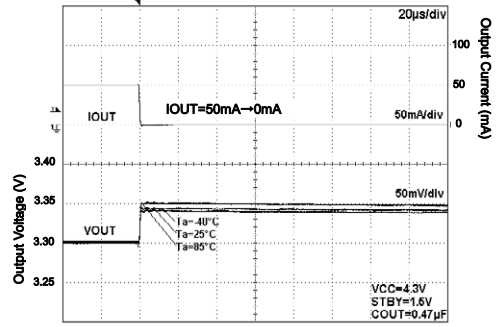

Fig.274. Load Response

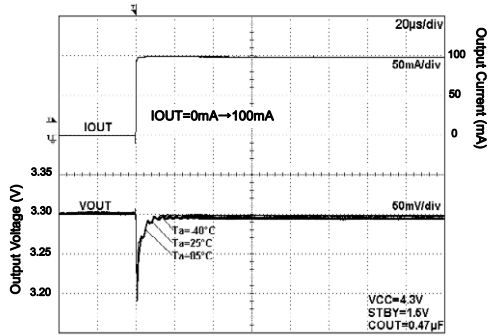

Fig.275. Load Response

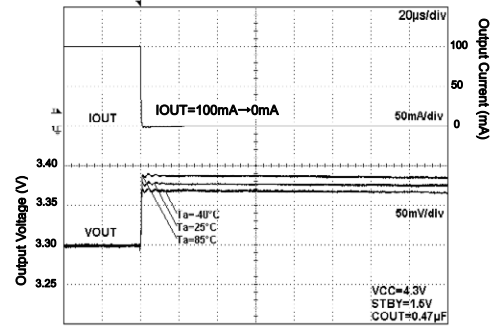

Fig.276. Load Response

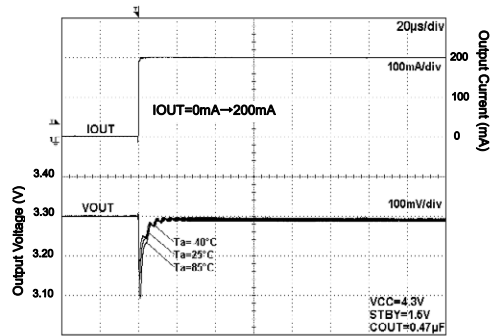

Fig.277. Load Response

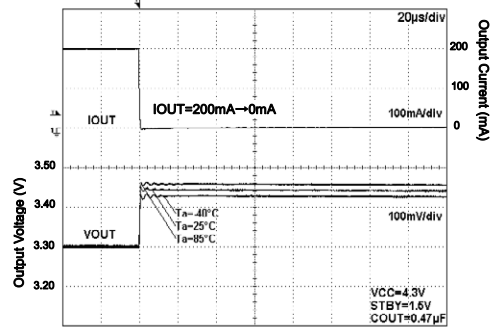

Fig.278. Load Response

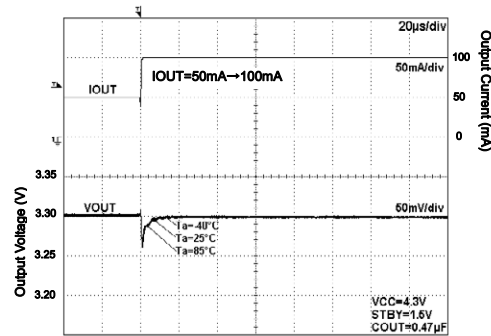

Fig.279. Load Response

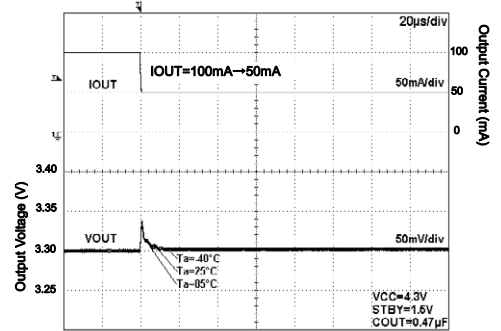

Fig.280. Load Response

●Reference data BU33TD2WNVX (Ta=25°C unless otherwise specified.)

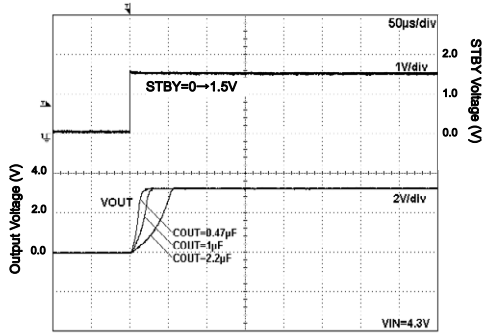

Fig.281. Start Up Time  
Iout=0mA

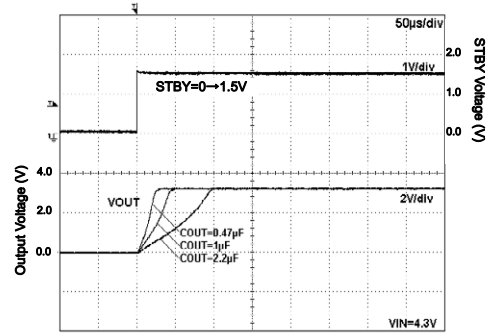

Fig.282. Start Up Time  
Iout=200mA

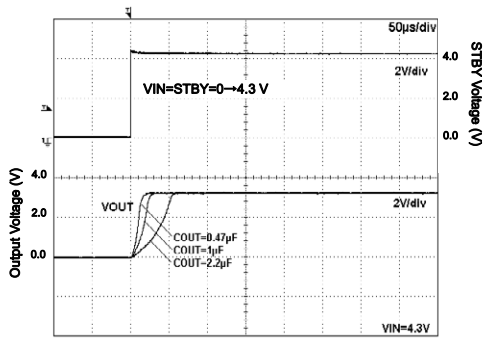

Fig.283. Start Up Time  
(VIN=STBY) Iout=0mA

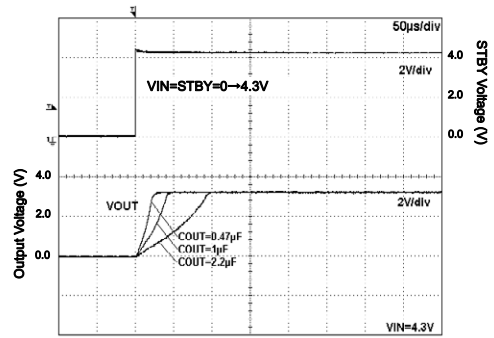

Fig.284. Start Up Time  
(VIN=STBY) Iout=200mA

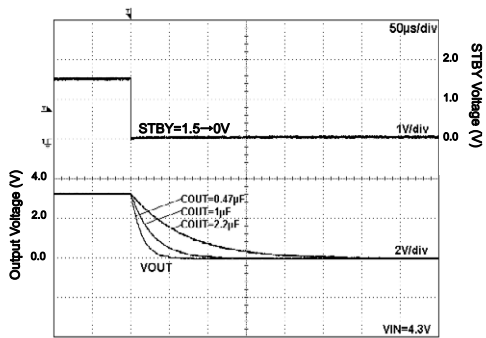

Fig.285. Discharge Time

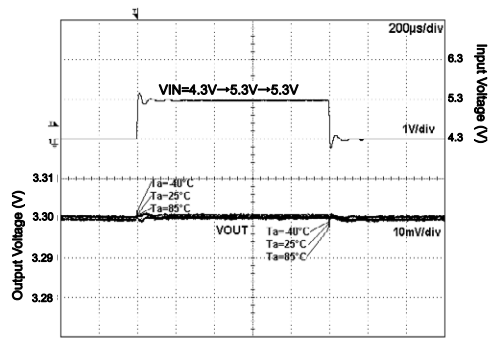

Fig.286. VIN Response

● About power dissipation (Pd)

As for power dissipation, an approximate estimate of the heat reduction characteristics and internal power consumption of IC are shown, so please use these for reference. Since power dissipation changes substantially depending on the implementation conditions (board size, board thickness, metal wiring rate, number of layers and through holes, etc.), it is recommended to measure Pd on a set board. Exceeding the power dissipation of IC may lead to deterioration of the original IC performance, such as causing operation of the thermal shutdown circuit or reduction in current capability. Therefore, be sure to prepare sufficient margin within power dissipation for usage.

Calculation of the maximum internal power consumption of IC (P<sub>MAX</sub>)

$$P_{MAX} = (V_{IN} - V_{OUT}) \times I_{OUT(MAX)}$$

(V<sub>IN</sub>: Input voltage V<sub>OUT</sub>: Output voltage I<sub>OUT(MAX)</sub>: Maximum output current)

○ Measurement conditions

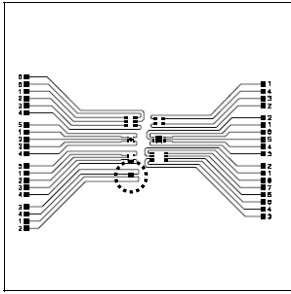
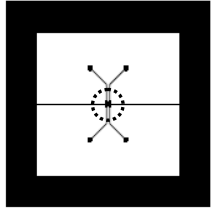
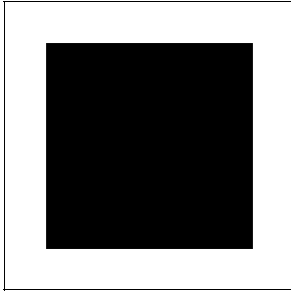
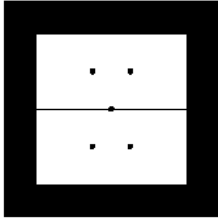
	Standard ROHM Board	Evaluation Board 1	
Layout of Board for Measurement   IC Implementation Position	 Top Layer (Top View)	 Top Layer (Top View)	
	 Bottom Layer (Top View)	 Bottom Layer (Top View)	
	Measurement State	With board implemented (Wind speed 0 m/s)	With board implemented (Wind speed 0 m/s)
Board Material	Glass epoxy resin (Double-side board)	Glass epoxy resin (Double-side board)	
Board Size	70 mm x 70 mm x 1.6 mm	40 mm x 40 mm x 1.6 mm	
Wiring Rate	Top layer	Metal (GND) wiring rate: Approx. 0%	Metal (GND) wiring rate: Approx. 50%
	Bottom layer	Metal (GND) wiring rate: Approx. 50%	Metal (GND) wiring rate: Approx. 50%
Through Hole	Diameter 0.5mm x 6 holes	Diameter 0.5mm x 25 holes	
Power Dissipation	0.56W	0.39W	
Thermal Resistance	θ <sub>ja</sub> =178.6°C/W	θ <sub>ja</sub> =256.4°C/W	

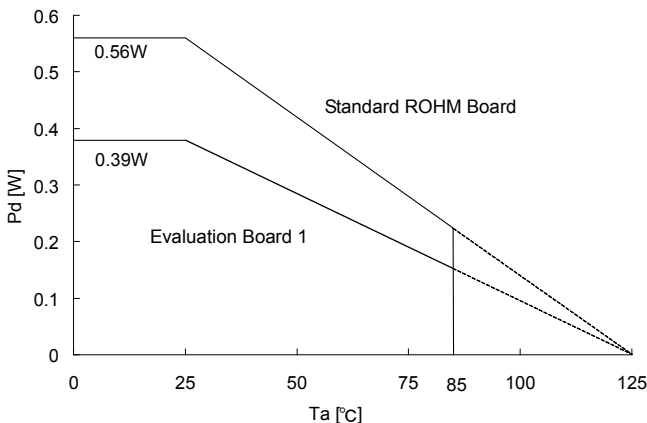

\* Please design the margin so that P<sub>MAX</sub> becomes is than Pd (P<sub>MAX</sub><Pd) within the usage temperature range.

Figure 287. SSON004X1010 Power dissipation heat reduction characteristics (Reference)

●Device Name and Marking

Device Name : BU□□TD2WNVX  
 ↑  
 a

Symbol	Description		Marking
	□□	Output Voltage	
a	10	1.0V typ.	A
	12	1.2V typ.	B
	15	1.5V typ.	C
	18	1.8V typ.	D
	1J	1.85V typ.	E
	19	1.9V typ.	F
	20	2.0V typ.	G
	2A	2.05V typ.	r
	21	2.1V typ.	0
	23	2.3V typ.	1
	25	2.5V typ.	H
	26	2.6V typ.	J
	27	2.7V typ.	K
	28	2.8V typ.	L
	2J	2.85V typ.	M
	29	2.9V typ.	N
	30	3.0V typ.	P
	31	3.1V typ.	Q
32	3.2V typ.	R	
33	3.3V typ.	U	
34	3.4V typ.	Y	

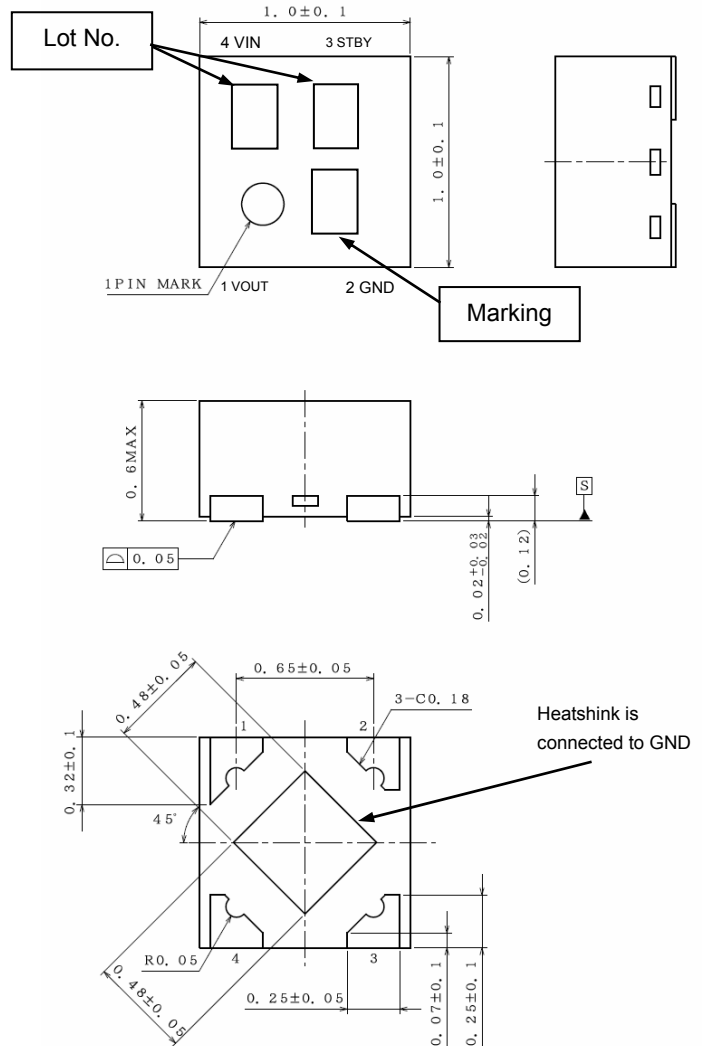

Fig.288. Package dimension and Marking

### ● Notes for use

- 1) About absolute maximum rating  
Breakage may occur when absolute maximum ratings such as applied voltage and operating temperature range are exceeded. Short mode or open mode cannot be specified at occurrence of a break, so please prepare physical safety measures (e.g., fuse) if such special mode in which the absolute maximum rating is exceeded can be assumed.
- 2) About GND potential  
Please be sure that the potential of the GND terminal is the lowest in any operating condition.
- 3) About thermal design  
Please provide thermal design with sufficient margin, taking power dissipation ( $P_d$ ) in actual usage conditions into consideration.
- 4) About short between pins and misattachment  
Please be careful regarding the IC direction and misalignment at attachment onto a printed circuit board. Misattachment may cause a break of IC. Short caused by foreign matter between outputs, output and power supply, or GNDs may also lead to a break.
- 5) About operation in a strong electromagnetic field  
Please note that usage in a strong electromagnetic field may cause malfunction.
- 6) About common impedance  
Please give due consideration to wiring of the power source and GND by reducing common-mode ripple or making ripple as small as possible (e.g., making the wiring as thick and short as possible, or reducing ripple by L-C), etc.
- 7) About STBY terminal voltage  
Set STBY terminal voltage to 0.3 V or less to put each channel into a standby state and to 1.2 V or more to put each channel into an operating state. Do not fix STBY terminal voltage to 0.3 V or more and 1.2 V or less or do not lengthen the transition time. This may cause malfunction or failure.  
When shorting the VIN terminal and STBY terminal for usage, the status will be "STBY=VIN=LOW" at turning the power OFF, and discharge of the VOUT terminal cannot operate, which means voltage may remain for a certain time in the VOUT terminal. Since turning the power ON again in this state may cause overshoot, turn the power ON for use after the VOUT terminal is completely discharged.
- 8) About overcurrent protection circuit  
Output has a built-in overcurrent protection circuit, which prevents IC break at load short. Note that this protection circuit is effective for prevention of breaks due to unexpected accidents. Please avoid usage by which the protection circuit operates continuously.
- 9) About thermal shutdown  
Output is OFF when the thermal circuit operates since a temperature protection circuit is built in to prevent thermal breakdown. However, it recovers when the temperature returns to a certain temperature. The thermal circuit operates at emergency such as overheating of IC. Since it is prepared to prevent IC breakdown, please do not use it in a state in which protection works.

### ● About reverse current

For applications on which reverse current is assumed to flow into IC, it is recommended to prepare a path to let the current out putting a bypass diode between the VIN-VOUT terminals.

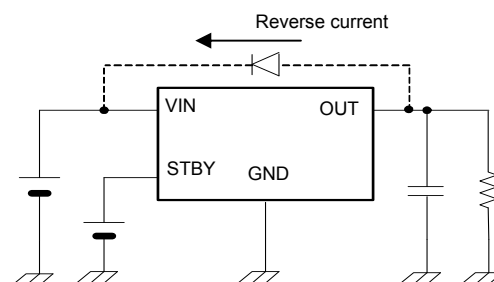

Fig. 289. Example of bypass diode connection

### ● About testing on a set board

When connecting a capacitor to a terminal with low impedance for testing on a set board, please be sure to discharge for each process since IC may be stressed. As a countermeasure against static electricity, prepare grounding in the assembly process and take sufficient care in transportation and storage. In addition, when connecting a capacitor to a jig in a testing process, please do so after turning the power OFF and remove it after turning the power OFF.



●Ordering part number

B	U	1	2	T	D	2	W	N	V	X	-	T	L
Part No.		Output Voltage		Line up				Package			Packaging and forming specification		
		10 : 1.0V 12 : 1.2V 15 : 1.5V 18 : 1.8V 1J : 1.85V 19 : 1.9V 20 : 2.0V 2A : 2.05V 21 : 2.1V 23 : 2.3V 25 : 2.5V 26 : 2.6V 27 : 2.7V 28 : 2.8V 2J : 2.85V 29 : 2.9V 30 : 3.0V 31 : 3.1V 32 : 3.2V 33 : 3.3V 34 : 3.4V						NVX : SSON004X1010			TL: Embossed tape and reel		

SSON004X1010

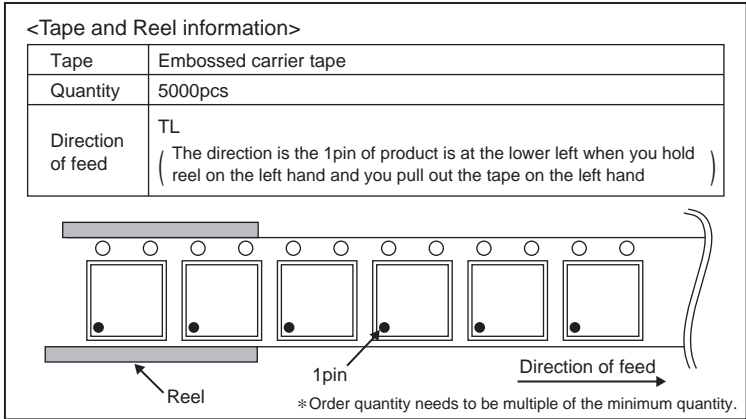
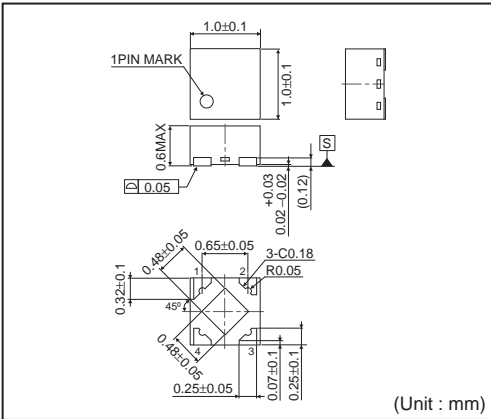

## Notes

No copying or reproduction of this document, in part or in whole, is permitted without the consent of ROHM Co.,Ltd.

The content specified herein is subject to change for improvement without notice.

The content specified herein is for the purpose of introducing ROHM's products (hereinafter "Products"). If you wish to use any such Product, please be sure to refer to the specifications, which can be obtained from ROHM upon request.

Examples of application circuits, circuit constants and any other information contained herein illustrate the standard usage and operations of the Products. The peripheral conditions must be taken into account when designing circuits for mass production.

Great care was taken in ensuring the accuracy of the information specified in this document. However, should you incur any damage arising from any inaccuracy or misprint of such information, ROHM shall bear no responsibility for such damage.

The technical information specified herein is intended only to show the typical functions of and examples of application circuits for the Products. ROHM does not grant you, explicitly or implicitly, any license to use or exercise intellectual property or other rights held by ROHM and other parties. ROHM shall bear no responsibility whatsoever for any dispute arising from the use of such technical information.

The Products specified in this document are intended to be used with general-use electronic equipment or devices (such as audio visual equipment, office-automation equipment, communication devices, electronic appliances and amusement devices).

The Products specified in this document are not designed to be radiation tolerant.

While ROHM always makes efforts to enhance the quality and reliability of its Products, a Product may fail or malfunction for a variety of reasons.

Please be sure to implement in your equipment using the Products safety measures to guard against the possibility of physical injury, fire or any other damage caused in the event of the failure of any Product, such as derating, redundancy, fire control and fail-safe designs. ROHM shall bear no responsibility whatsoever for your use of any Product outside of the prescribed scope or not in accordance with the instruction manual.

The Products are not designed or manufactured to be used with any equipment, device or system which requires an extremely high level of reliability the failure or malfunction of which may result in a direct threat to human life or create a risk of human injury (such as a medical instrument, transportation equipment, aerospace machinery, nuclear-reactor controller, fuel-controller or other safety device). ROHM shall bear no responsibility in any way for use of any of the Products for the above special purposes. If a Product is intended to be used for any such special purpose, please contact a ROHM sales representative before purchasing.

If you intend to export or ship overseas any Product or technology specified herein that may be controlled under the Foreign Exchange and the Foreign Trade Law, you will be required to obtain a license or permit under the Law.



Thank you for your accessing to ROHM product informations.  
More detail product informations and catalogs are available, please contact us.

### ROHM Customer Support System

<http://www.rohm.com/contact/>