

$V_{RSM}$	=	4000 V
$I_{F(AV)M}$	=	4140 A
$I_{F(RMS)}$	=	6500 A
$I_{FSM}$	=	$46 \times 10^3$ A
$V_{F0}$	=	0.905 V
$r_F$	=	0.109 mW

# Rectifier Diode

## 5SDD 40H4000

Doc. No. 5SYA1176-00 March 05

- Very low on-state losses
- Optimum power handling capability

### Blocking

*Maximum rated values* <sup>1)</sup>

Parameter	Symbol	Conditions	Value	Unit
Repetitive peak reverse voltage	$V_{RRM}$	$f = 50$ Hz, $t_p = 10$ ms, $T_j = -40 \dots 160$ °C	4000	V
Non - repetitive peak reverse voltage	$V_{RSM}$	$f = 5$ Hz, $t_p = 10$ ms, $T_j = -40 \dots 160$ °C	4000	V

*Characteristic values*

Parameter	Symbol	Conditions	min	typ	max	Unit
Max. (reverse) leakage current	$I_{RRM}$	$V_{RRM}$ , $T_j = 160$ °C			100	mA

### Mechanical data

*Maximum rated values* <sup>1)</sup>

Parameter	Symbol	Conditions	min	typ	max	Unit
Mounting force	$F_M$		45	50	55	kN
Acceleration	a	Device unclamped			50	m/s <sup>2</sup>
Acceleration	a	Device clamped			100	m/s <sup>2</sup>

*Characteristic values*

Parameter	Symbol	Conditions	min	typ	max	Unit
Weight	m			0.9		kg
Housing thickness	H	$F_M = 50$ kN, $T_a = 25$ °C	25.5		26.5	mm
Surface creepage distance	$D_S$		40			mm
Air strike distance	$D_a$		20			mm

1) Maximum rated values indicate limits beyond which damage to the device may occur

ABB Switzerland Ltd, Semiconductors reserves the right to change specifications without notice.



## On-state

### Maximum rated values <sup>1)</sup>

Parameter	Symbol	Conditions	min	typ	max	Unit
Max. average on-state current	$I_{F(AV)M}$	50 Hz, Half sine wave, $T_C = 85^\circ\text{C}$			4140	A
Max. RMS on-state current	$I_{F(RMS)}$				6500	A
Max. peak non-repetitive surge current	$I_{FSM}$	$t_p = 10\text{ ms}$ , $T_j = 160^\circ\text{C}$ , $V_R = 0\text{ V}$			$46 \times 10^3$	A
Limiting load integral	$I^2t$				$10.58 \times 10^6$	$\text{A}^2\text{s}$
Max. peak non-repetitive surge current	$I_{FSM}$	$t_p = 8.3\text{ ms}$ , $T_j = 160^\circ\text{C}$ , $V_R = 0\text{ V}$			$49 \times 10^3$	A
Limiting load integral	$I^2t$				$10.02 \times 10^6$	$\text{A}^2\text{s}$

### Characteristic values

Parameter	Symbol	Conditions	min	typ	max	Unit
On-state voltage	$V_F$	$I_F = 4000\text{ A}$ , $T_j = 160^\circ\text{C}$			1.310	V
Threshold voltage	$V_{(T0)}$	$T_j = 160^\circ\text{C}$			0.905	V
Slope resistance	$r_T$	$I_T = 6000 \dots 19000\text{ A}$			0.109	$\text{m}\Omega$

## Switching

### Characteristic values

Parameter	Symbol	Conditions	min	typ	max	Unit
Recovery charge	$Q_{rr}$	$di_F/dt = -30\text{ A}/\mu\text{s}$ , $V_R = 100\text{ V}$ $I_{FRM} = 2000\text{ A}$ , $T_j = 160^\circ\text{C}$		4600		$\mu\text{As}$

# Thermal

Maximum rated values <sup>1)</sup>

Parameter	Symbol	Conditions	min	typ	max	Unit
Operating junction temperature range	T <sub>vj</sub>		-40		160	°C
Storage temperature range	T <sub>stg</sub>		-40		160	°C

## Characteristic values

Parameter	Symbol	Conditions	min	typ	max	Unit
Thermal resistance junction to case	R <sub>th(j-c)</sub>	Double-side cooled F <sub>m</sub> = 45...55 kN			8	K/kW
	R <sub>th(j-c)A</sub>	Anode-side cooled F <sub>m</sub> = 45...55 kN			14.5	K/kW
	R <sub>th(j-c)C</sub>	Cathode-side cooled F <sub>m</sub> = 45...55 kN			18.0	K/kW
Thermal resistance case to heatsink	R <sub>th(c-h)</sub>	Double-side cooled F <sub>m</sub> = 45...55 kN			2.5	K/kW
	R <sub>th(c-h)</sub>	Single-side cooled F <sub>m</sub> = 45...55 kN			5.0	K/kW

Analytical function for transient thermal impedance:

$$Z_{th(j-c)}(t) = \sum_{i=1}^n R_{th i} (1 - e^{-t/t_i})$$

i	1	2	3	4
R <sub>th i</sub> (K/kW)	4.533	2.255	0.868	0.345
τ <sub>i</sub> (s)	0.4406	0.1045	0.0092	0.0022

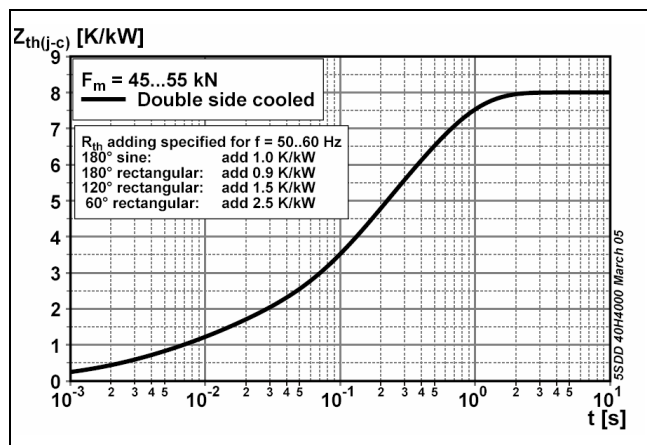

Fig. 1 Transient thermal impedance junction-to-case.

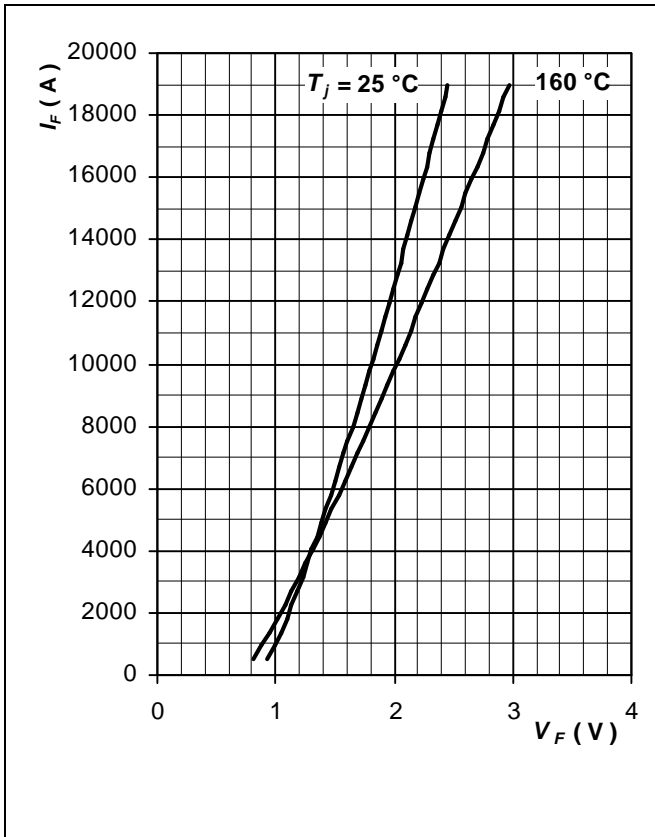

Fig. 2 Max. on-state characteristics.

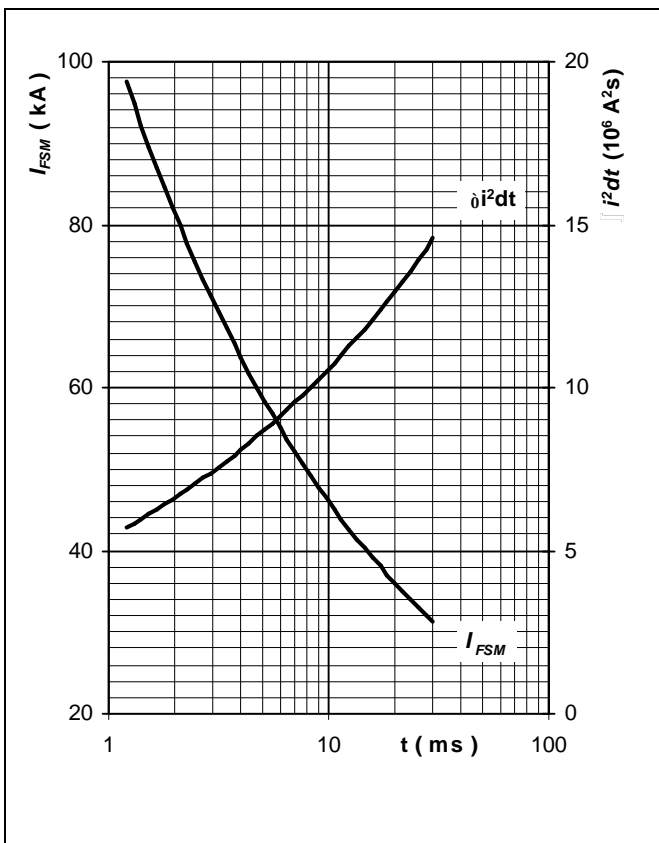

Fig. 3 Surge forward current vs. pulse length. Half sine wave, single pulse,  $V_R = 0\text{ V}$

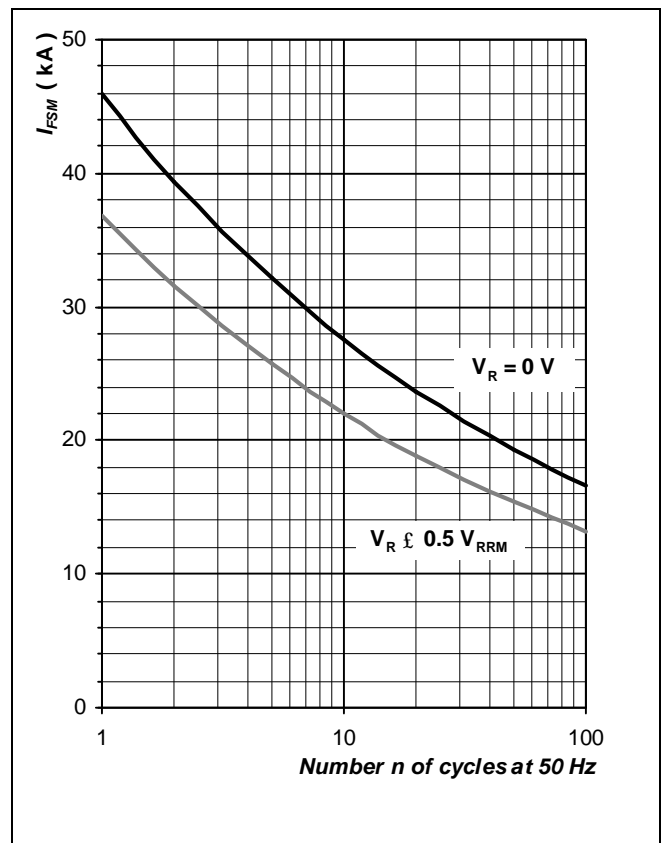
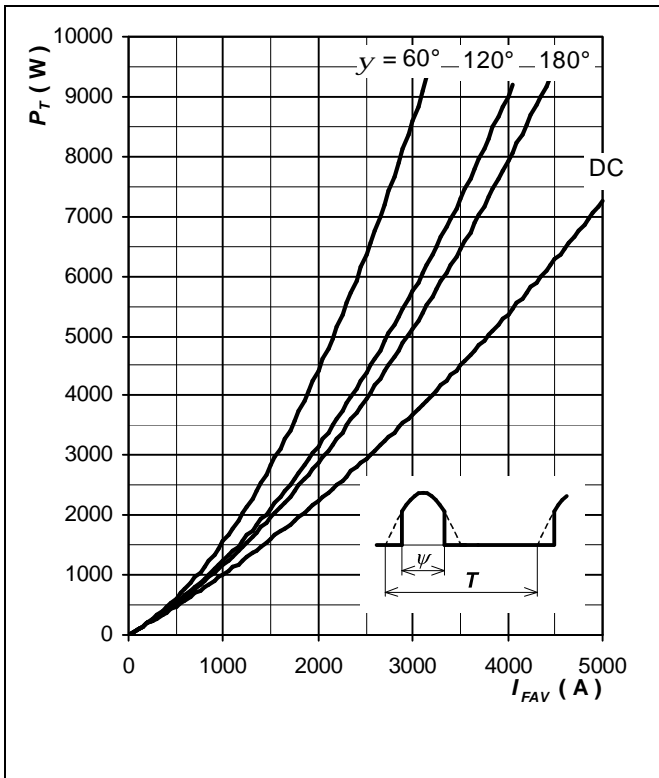
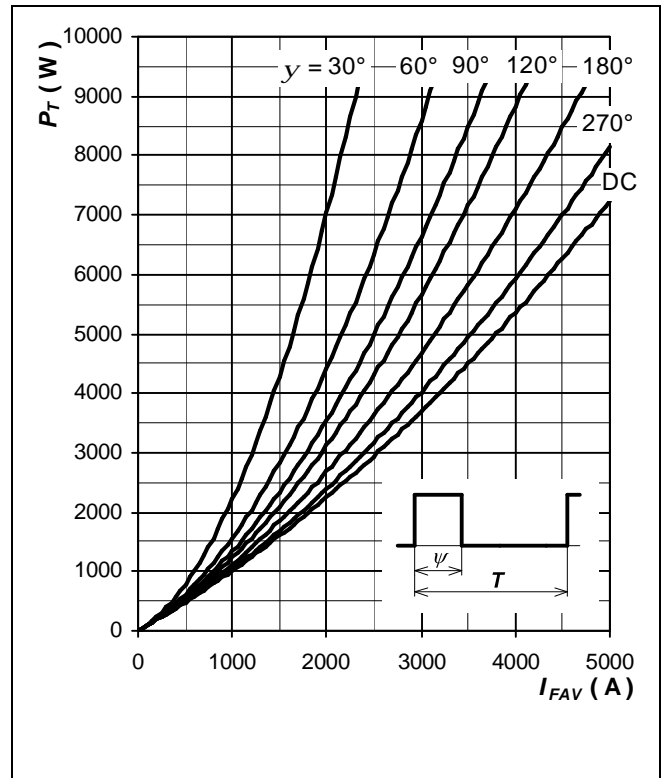

Fig. 4 Surge forward current vs. number of pulses. Half sine wave,  $V_R = 0\text{ V}$



**Fig. 5** Forward power loss vs. average forward current, sine waveform,  $f = 50$  Hz



**Fig. 6** Forward power loss vs. average forward current, square waveform,  $f = 50$  Hz

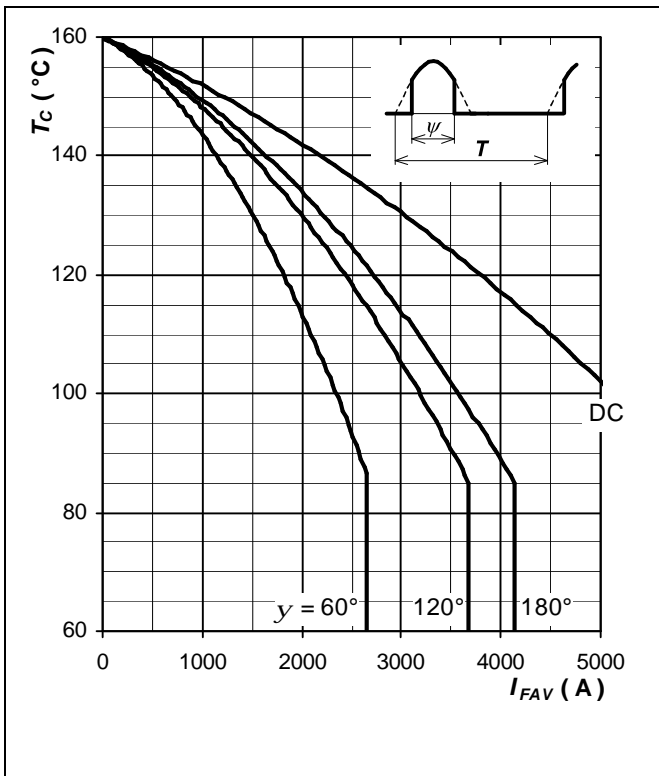

**Fig. 7** Max. case temperature vs. aver. forward current, sine waveform,  $f = 50$  Hz

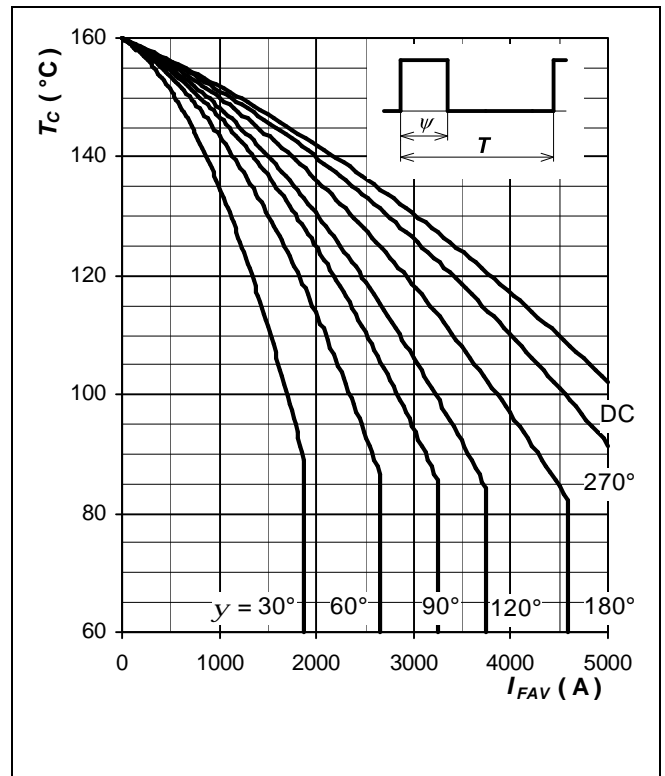

**Fig. 8** Max. case temperature vs. aver. forward current, square waveform,  $f = 50$  Hz

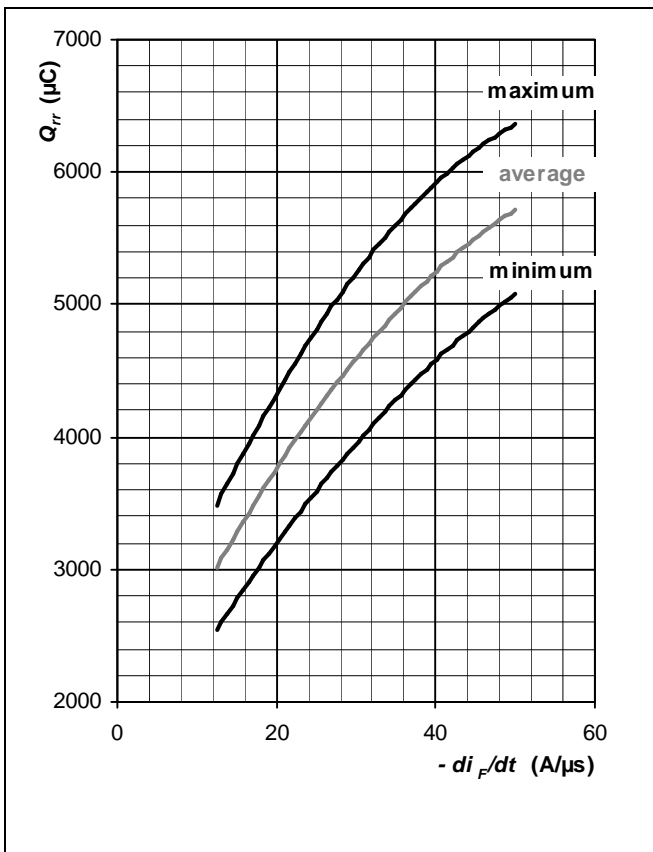

**Fig. 9** Reverse recovery charge vs.  $di_F/dt$ ,  $I_F = 2000 \text{ A}$ ,  $V_R = 100 \text{ V}$ ,  $T_j = T_{j\text{max}}$ , limit values

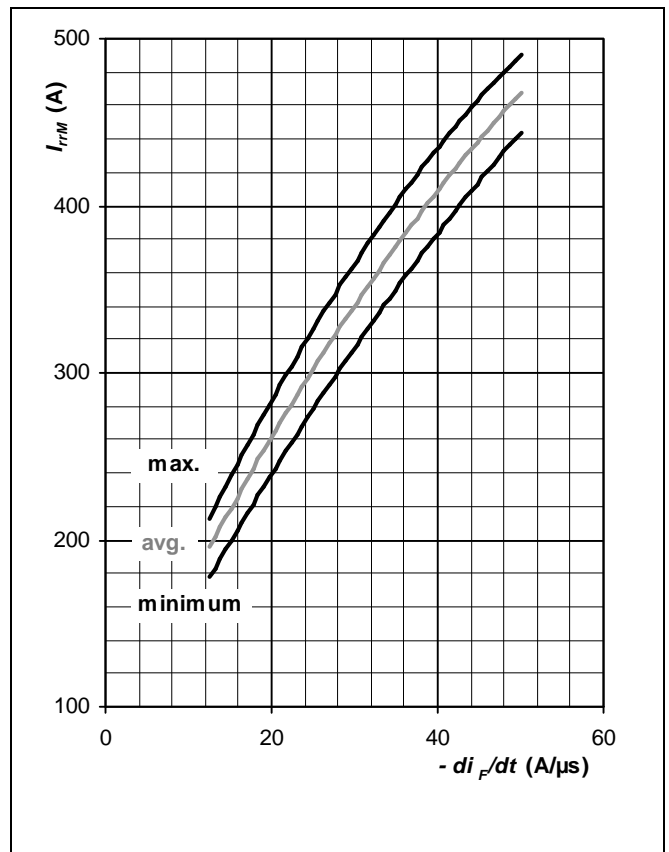

**Fig. 10** Peak reverse recovery current vs.  $di_F/dt$ ,  $I_F = 2000 \text{ A}$ ,  $V_R = 100 \text{ V}$ ,  $T_j = T_{j\text{max}}$ , limit values

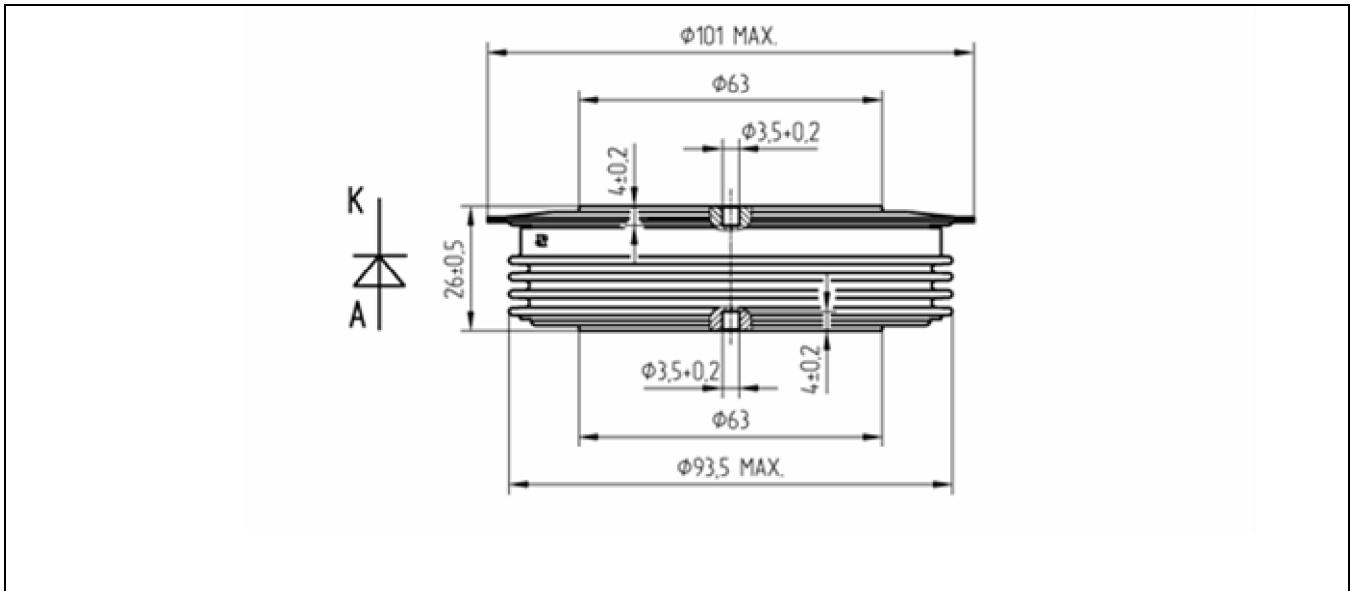

**Fig. 11** Outline drawing. All dimensions are in millimeters and represent nominal values unless stated otherwise.

### Related application notes:

Doc. Nr	Titel
5SYA 2020	Design of RC-Snubbers for Phase Control Applications
5SYA 2029	Designing Large Rectifiers with High Power Diodes
5SYA 2036	Recommendations regarding mechanical clamping of Press Pack High Power Semiconductors

Please refer to <http://www.abb.com/semiconductors> for actual versions.

ABB Switzerland Ltd, Semiconductors reserves the right to change specifications without notice.



**ABB Switzerland Ltd**  
**Semiconductors**  
 Fabrikstrasse 3  
 CH-5600 Lenzburg, Switzerland

Doc. No. 5SYA1176-00 March 05

Telephone +41 (0)58 586 1419  
 Fax +41 (0)58 586 1306  
 Email [abbsem@ch.abb.com](mailto:abbsem@ch.abb.com)  
 Internet [www.abb.com/semiconductors](http://www.abb.com/semiconductors)