

HFS15(JGX-1505FB)**SOLID STATE RELAY****CRUS**

File No: E133481



File No.: B050453286001(D-240 type)



File No: CQC02001001936

**Features**

- 4000V dielectric strength
- Photo isolation
- Removable finger proof cover available
- Built-in snubber
- Zero cross or random turn-on
- TRIAC AC output
- Panel mount
- DC or AC control
- With LED indicator or not
- RoHS compliant

INPUT (TA = 25°C)

Control voltage range (DC input)	3 to 32VDC (Without LED) 4 to 32VDC (With LED)
Control voltage range (AC input)	85 to 132VAC (110V input) 175 to 264VAC (220V input) 19.2 to 28.8VAC (24V input)
Must operate voltage (DC input)	Max. 3VDC (Without LED) Max. 4VDC (With LED)
Must operate voltage (AC input)	85VAC (110V input) 175VAC (220V input) 19.2VAC (24V input)
Must release voltage (DC input)	1.0VDC
Must release voltage (AC input)	10VAC (110V, 220V input) 2VAC (24V input)
Max. input current	25mA (DC input) 15mA (AC input)
Max. reverse protection voltage (DC input)	-32VDC

GENERAL (TA = 25°C)

Type	D-□A10□	D-□A15□	D-□A20□	D-□A25□	D-□A40□
Dielectric strength (input to output)	4000VAC, 50/60Hz, 1min				
Insulation resistance	1000MΩ (at 500VDC)				
Ambient temperature	Operating	-30°C to 80°C			
	Storage	-30°C to 100°C			
Unit weight	Approx. 88g				

Notes: All parameters at 25°C.

DESCRIPTION

The HFS15 offer 3-32VDC, 24VAC, 110VAC or 220VAC input control, with outputs rated at 10A, 15A, 20A, 25A or 40A. All models include an internal snubber. The relays provide 4000VAC opto-isolation, between input and output. Outline dimension is 58.4mmX45.7mmX22.9mm.

PRECAUTIONS

1. When choosing a SSR, please notice the actual load current and working ambient temperature. To use the SSR correctly, please refer to CHARACTERISTIC DATA and make sure the heat sink size when it works in full load current.
2. Apply heat-radiation silicon grease or a heat conductive sheet between the SSR and heat sink. There will be a space between the SSR and heat sink. Attached to the SSR. Therefore, the generated heat of the SSR cannot be radiated properly without the grease. As a result, the SSR may be overheated and damaged or deteriorated.
3. Tighten the SSR terminal screws properly. If the screws are not tight, the SSR will be Damaged by heat generated when the power in ON. Perform wiring using the tightening torque shown in the following table.

Screw size	Recommended tightened torque
M3	0.58 to 0.98 N·m
M4	0.98 to 1.37 N·m

OUTPUT (TA = 25°C)

Type	D-□A10□	D-□A15□	D-□A20□	D-□A25□	D-□A40□
Load voltage range (at 47-63Hz)	D-240A□□		48 to 280VAC		
	D-380A□□		48 to 440VAC		
Max. transient overvoltage	D-240A□□		600Vpk		
	D-380A□□		800Vpk		
Load current range (A)	0.1 to 10	0.1 to 15	0.1 to 20	0.1 to 25	0.1 to 40
Max. I ² t for fusing(10ms, A ² s)	78	144	312	312	880
Max. surge current (10ms)	100Apk	150Apk	200Apk	250Apk	400Apk
Max. leakage current	5mA	5mA	5mA	5mA	5mA
Max. on-state voltage drop	1.5Vrms				
Max. turn-on time	Zero cross turn on: 1/2 cycle+1ms				
	Random turn-on: 1ms				
Max. turn-off time	1/2 cycle+1ms				
Min. off-state dv/dt	200V/μs				
Min. power factor	0.5				



HONGFA RELAY

ISO9001、ISO/TS16949、ISO14001、OHSAS18001 CERTIFIED

2007 Rev. 1.00

ORDERING INFORMATION

Type	HFS15 / D- 240 A 10 Z -L (XXX)						
Input voltage	D: 3 to 32VDC (Without LED) 4 to 32VDC (With LED) 24A: 24VAC 110A: 110VAC 220A: 220VAC						
Load voltage	240: 240V 380: 380V						
Load voltage form	A: AC						
Load current	10: 10A 15: 15A 20: 20A 25: 25A 40: 40A						
Zero cross function	Z: Zero cross turn-on P: Random turn-on						
LED indicator	L: With LED Nil: Without LED						
Customer special code	Only for special requirements, e.g. (555) stands for RoHS compliant						

Notes: HFS15 is an environmental friendly product, please mark special code (555) when order.

OUTLINE DIMENSIONS, WIRING DIAGRAM AND MOUNTING HOLES

Unit: mm

Outline Dimensions

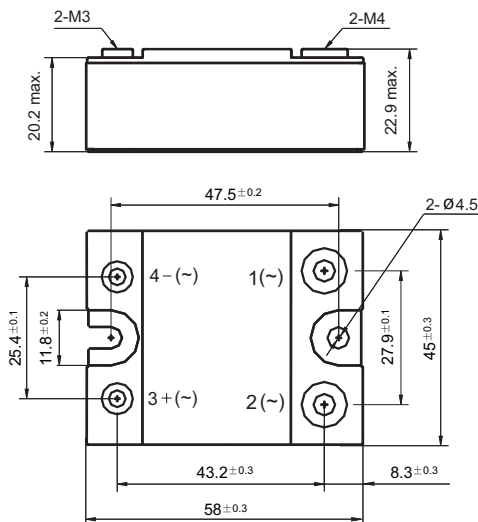

Mounting Hole Layout

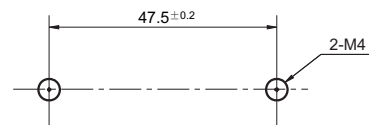

Wiring Diagram

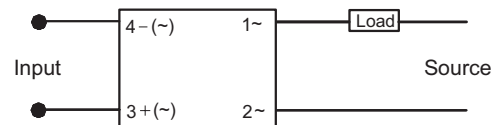

CHARACTERISTIC CURVES

Max. Permissible Non-repetitive Peak Surge Current vs. Number of Cycles

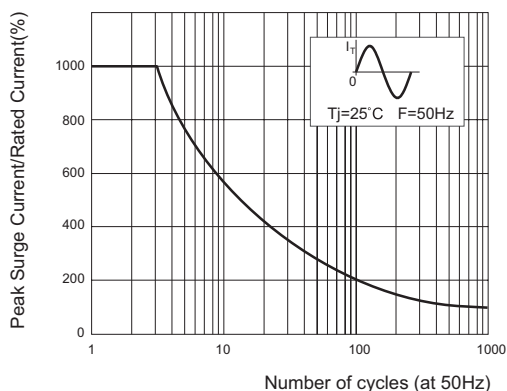

Max. Load Current vs. Ambient Temp. (10A)

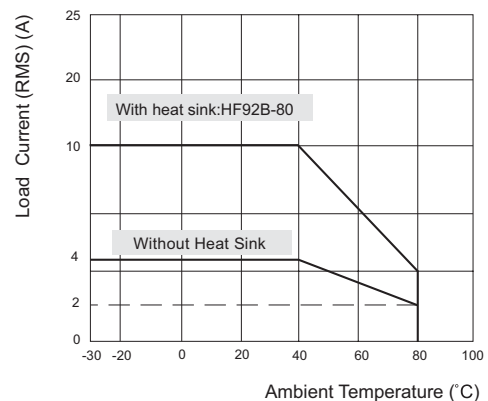

CHARACTERISTICS CURVES

Max. Load Current vs. Ambient Temp. (15A)

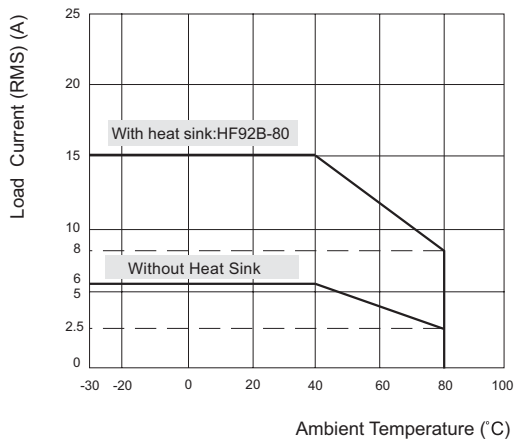

Max. Load Current vs. Ambient Temp. (20A)

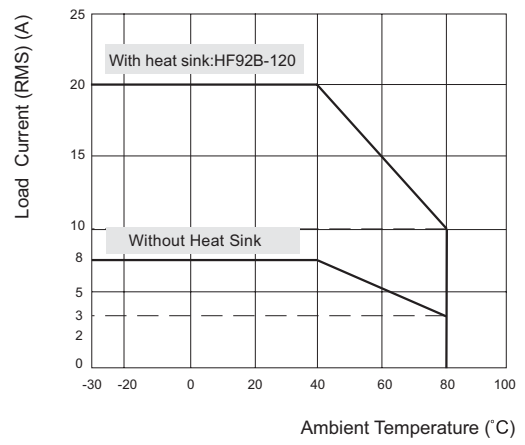

Max. Load Current vs. Ambient Temp. (25A)

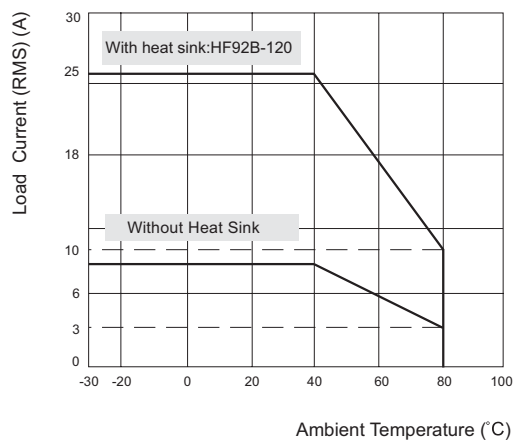

Max. Load Current vs. Ambient Temp. (40A)

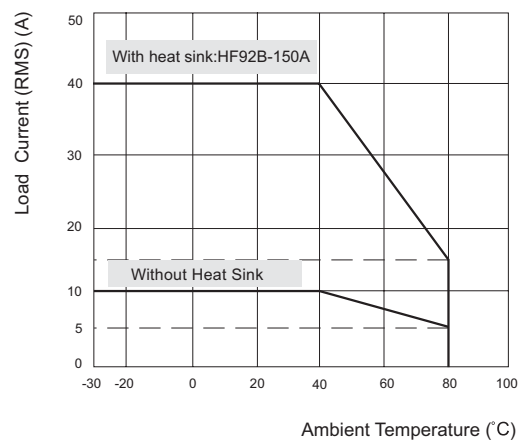

Disclaimer

This datasheet is for the customers' reference. All the specifications are subject to change without notice.

We could not evaluate all the performance and all the parameters for every possible application. Thus the user should be in a right position to choose the suitable product for their own application. If there is any query, please contact Hongfa for the technical service. However, it is the user's responsibility to determine which product should be used only.