

P-Channel Enhancement Mode MOSFET

### Features

- 30V/-13A,  $R_{DS(ON)} = 8m\Omega(\text{typ.}) @ V_{GS} = -20V$   
 $R_{DS(ON)} = 9m\Omega(\text{typ.}) @ V_{GS} = -10V$   
 $R_{DS(ON)} = 13m\Omega(\text{typ.}) @ V_{GS} = -4.5V$
- Super High Density Cell Design
- Reliable and Rugged
- SO-8 Package

### Pin Description

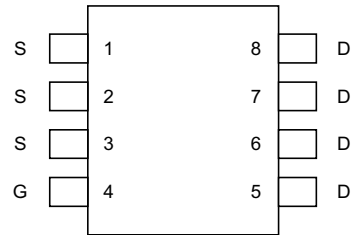

SO-8

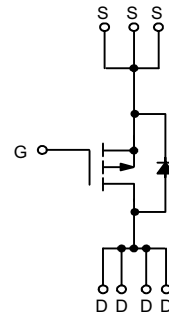

P-Channel MOSFET

### Applications

- Power Management in Notebook Computer, Portable Equipment and Battery Powered Systems

### Ordering and Marking Information

<p>APM4429 □□-□□□</p>	<p>Package Code K : SO-8</p> <p>Operation Junction Temp. Range C : -55 to 150°C</p> <p>Handling Code TU : Tube                      TR : Tape &amp; Reel</p> <p>Lead Free Code L : Lead Free Device      Bland : Orginal Device</p>
<p>APM4429 K:      <span style="border: 1px solid black; padding: 2px;">APM4429 XXXXX</span></p>	<p>XXXXX - Date Code</p>

### Absolute Maximum Ratings ( $T_A = 25^\circ C$ unless otherwise noted)

Symbol	Parameter	Rating	Unit
$V_{DSS}$	Drain-Source Voltage	-30	V
$V_{GSS}$	Gate-Source Voltage	$\pm 20$	
$I_D^*$	Maximum Drain Current – Continuous	-13	A
	$T_A = 25^\circ C$		
$I_{DM}$	Maximum Drain Current – Pulsed	-50	

\* Surface Mounted on FR4 Board,  $t \leq 10$  sec.

ANPEC reserves the right to make changes to improve reliability or manufacturability without notice, and advise customers to obtain the latest version of relevant information to verify before placing orders.

**Absolute Maximum Ratings** ( $T_A = 25^\circ\text{C}$  unless otherwise noted)

Symbol	Parameter	Rating	Unit	
$P_D$	Maximum Power Dissipation	$T_A = 25^\circ\text{C}$	2.5	W
		$T_A = 100^\circ\text{C}$	1.0	
$T_J, T_{STG}$	Maximum Operating and Storage Junction Temperature	-55 to 150	$^\circ\text{C}$	
$R_{\theta JA}^*$	Thermal Resistance - Junction to Ambient	62.5	$^\circ\text{C/W}$	

**Electrical Characteristics** ( $T_A = 25^\circ\text{C}$  unless otherwise noted)

Symbol	Parameter	Test Condition	APM4429			Unit
			Min.	Typ <sup>a</sup> .	Max.	
<b>Static</b>						
$BV_{DSS}$	Drain-Source Breakdown Voltage	$V_{GS}=0V, I_{DS}=-250\mu A$	-30			V
$I_{DSS}$	Zero Gate Voltage Drain Current	$V_{DS}=-24V, V_{GS}=0V$			-1	$\mu A$
$V_{GS(th)}$	Gate Threshold Voltage	$V_{DS}=V_{GS}, I_{DS}=-250\mu A$	-1	-1.5	-2	V
$I_{GSS}$	Gate Leakage Current	$V_{GS}=\pm 20V, V_{DS}=0V$			$\pm 100$	nA
$R_{DS(ON)}$	Drain-Source On-state Resistance <sup>b</sup>	$V_{GS}=-20V, I_{DS}=-13A$		8	11	m $\Omega$
		$V_{GS}=-10V, I_{DS}=-13A$		9	12	
		$V_{GS}=-4.5V, I_D=-12A$		13	17	
$V_{SD}$	Diode Forward Voltage <sup>b</sup>	$I_{SD}=-3A, V_{GS}=0V$		-0.7	-1.3	V
<b>Dynamic<sup>a</sup></b>						
$Q_g$	Total Gate Charge	$V_{DS}=-15V, V_{GS}=-10V$ $I_D=-13A$		105	135	nC
$Q_{gs}$	Gate-Source Charge			10.8		
$Q_{gd}$	Gate-Drain Charge			13.6		
$t_{d(ON)}$	Turn-on Delay Time	$V_{DD}=-15V, I_D=-1A,$ $V_{GEN}=-10V, R_G=6\Omega$ $R_L=15\Omega$		15	30	ns
$T_r$	Turn-on Rise Time			20	30	
$t_{d(OFF)}$	Turn-off Delay Time			55	85	
$T_f$	Turn-off Fall Time			40	65	
$C_{iss}$	Input Capacitance	$V_{GS}=0V$		4730		pF
$C_{oss}$	Output Capacitance	$V_{DS}=-25V$		800		
$C_{rss}$	Reverse Transfer Capacitance	Frequency=1.0MHz		240		

**Notes**

<sup>a</sup> : Pulse test ; pulse width  $\leq 300\mu s$ , duty cycle  $\leq 2\%$

<sup>b</sup> : Guaranteed by design, not subject to production testing

## Typical Characteristics

Output Characteristics

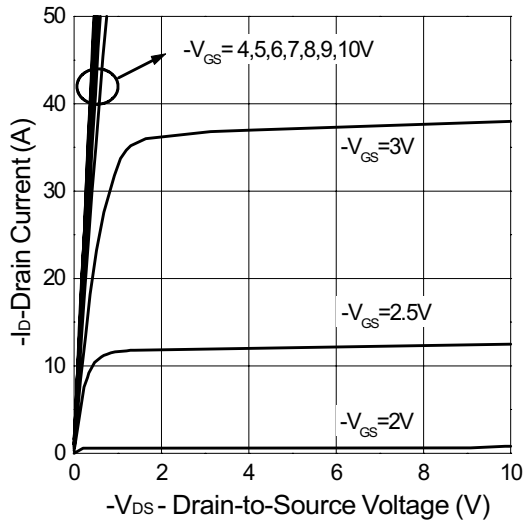

Transfer Characteristics

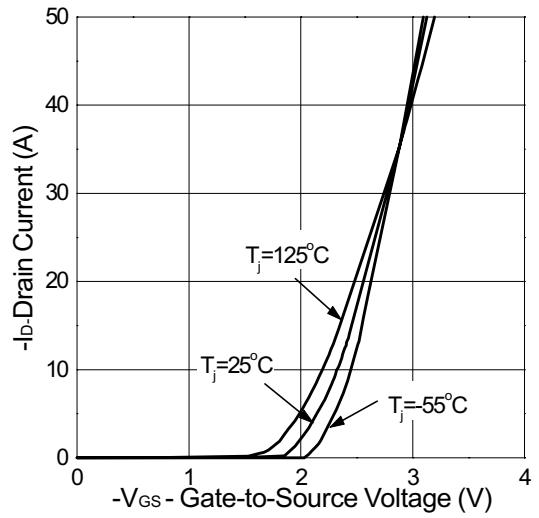

Threshold Voltage vs. Junction Temperature

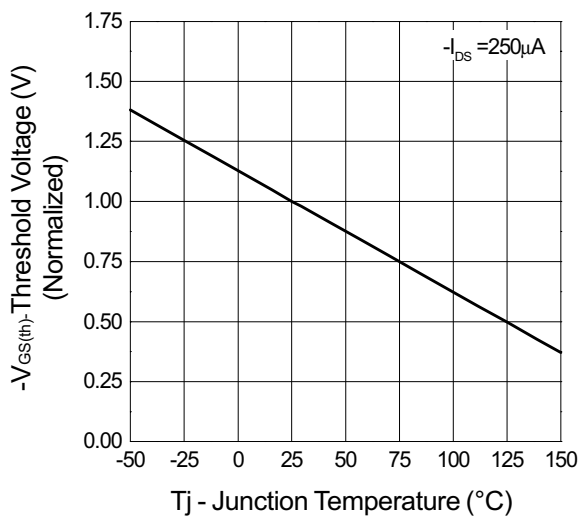

On-Resistance vs. Drain Current

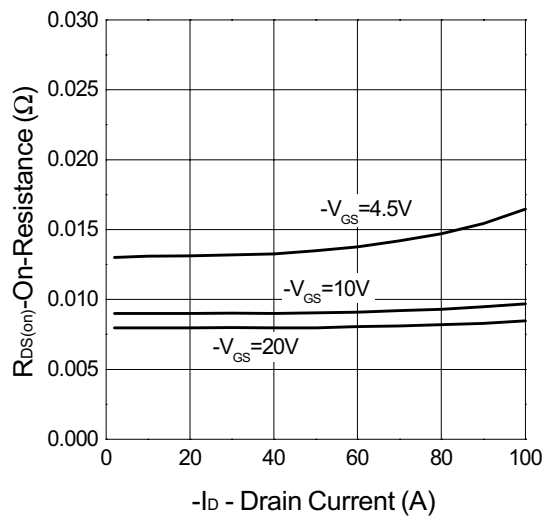

## Typical Characteristics

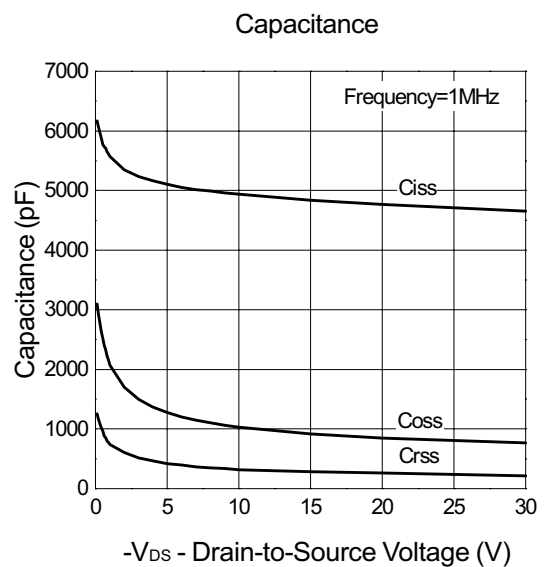
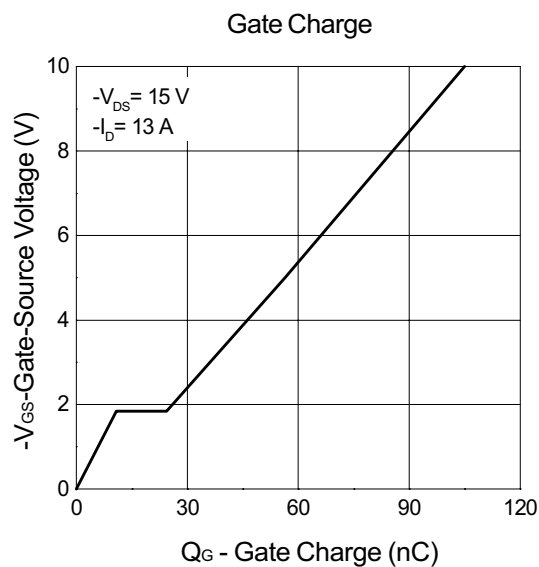
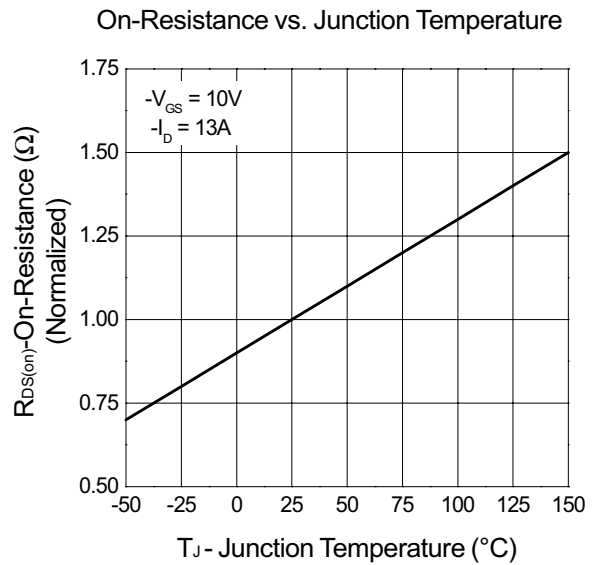
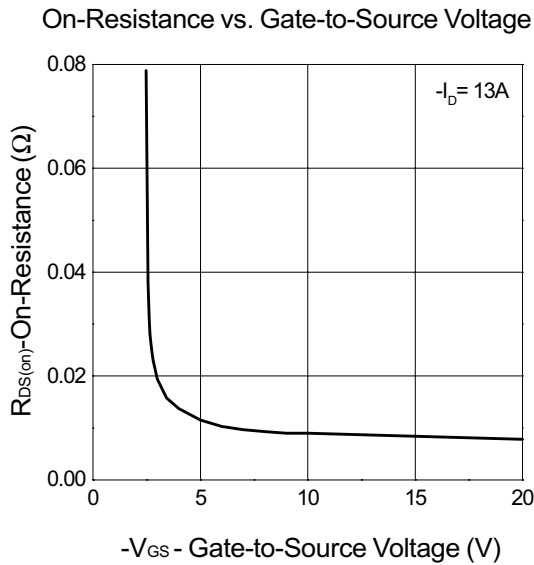

### Typical Characteristics

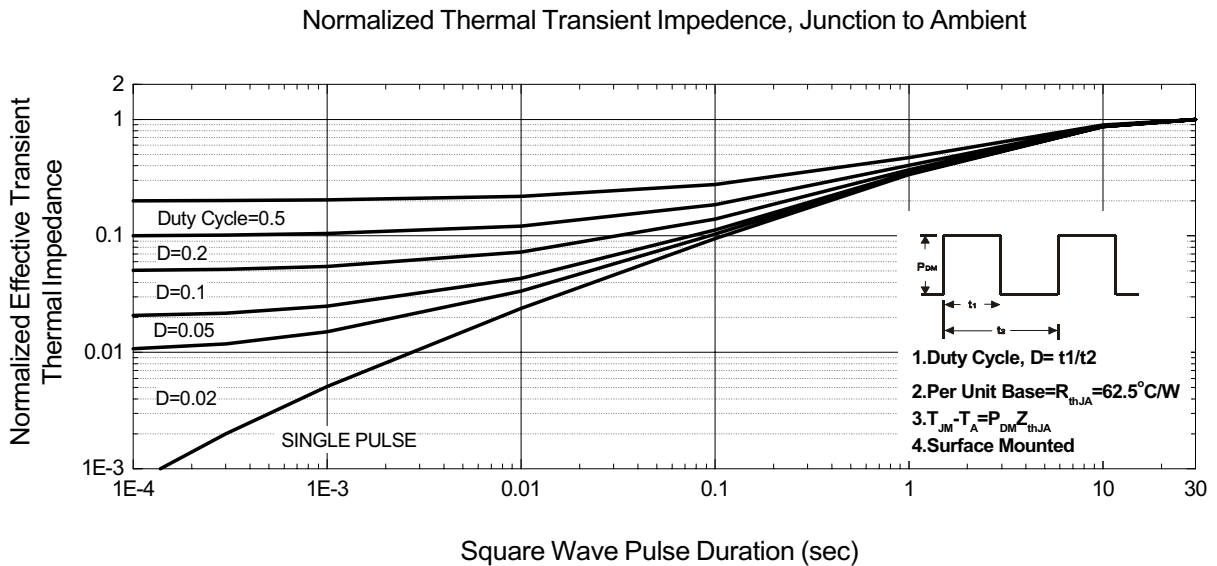
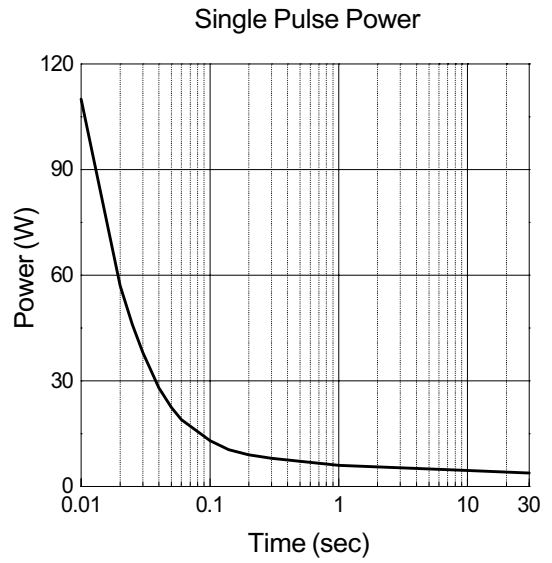
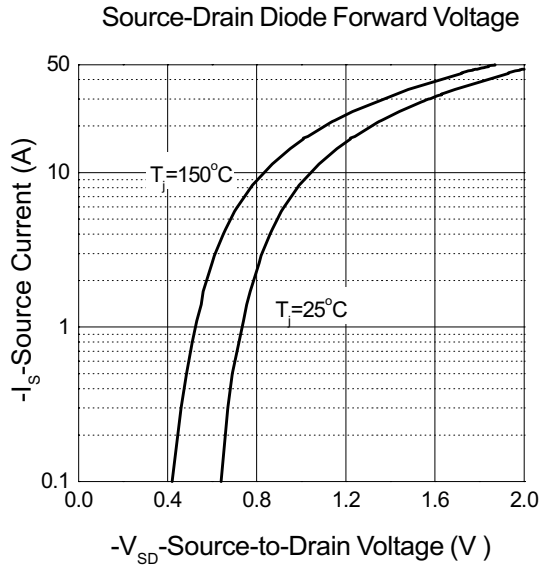

## Packaging Information

SOP-8 pin ( Reference JEDEC Registration MS-012)

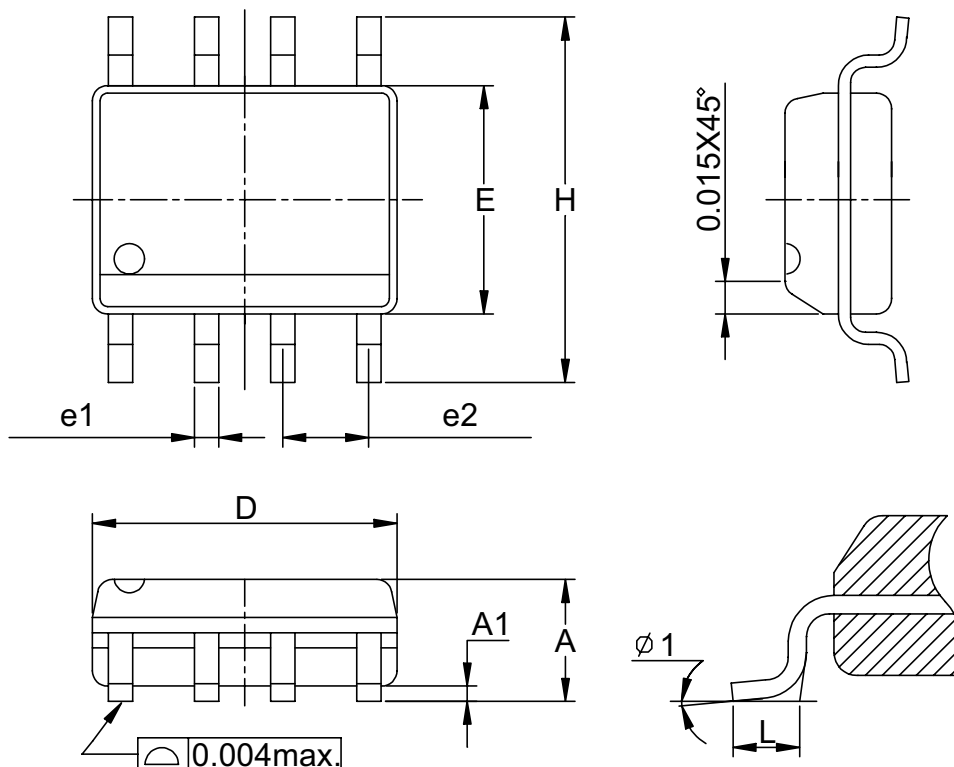

Dim	Millimeters		Inches	
	Min.	Max.	Min.	Max.
A	1.35	1.75	0.053	0.069
A1	0.10	0.25	0.004	0.010
D	4.80	5.00	0.189	0.197
E	3.80	4.00	0.150	0.157
H	5.80	6.20	0.228	0.244
L	0.40	1.27	0.016	0.050
e1	0.33	0.51	0.013	0.020
e2	1.27BSC		0.50BSC	
$\phi 1$	8°		8°	

## Physical Specifications

Terminal Material	Solder-Plated Copper (Solder Material : 90/10 or 63/37 SnPb)
Lead Solderability	Meets EIA Specification RSI86-91, ANSI/J-STD-002 Category 3.

## Reflow Condition (IR/Convection or VPR Reflow)

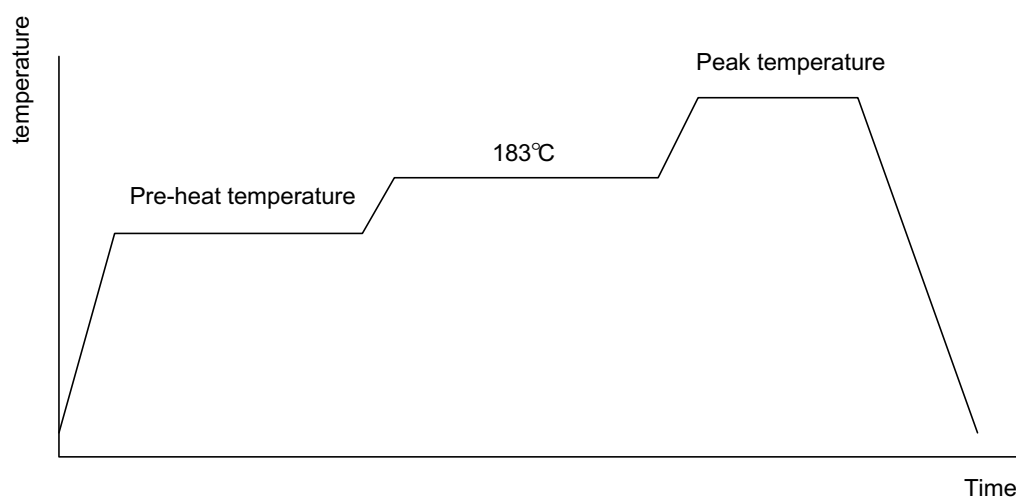

## Classification Reflow Profiles

	Convection or IR/ Convection	VPR
Average ramp-up rate(183°C to Peak)	3°C/second max.	10 °C /second max.
Preheat temperature 125 ± 25°C)	120 seconds max	
Temperature maintained above 183°C	60 – 150 seconds	
Time within 5°C of actual peak temperature	10 –20 seconds	60 seconds
Peak temperature range	220 +5/-0°C or 235 +5/-0°C	215-219°C or 235 +5/-0°C
Ramp-down rate	6 °C /second max.	10 °C /second max.
Time 25°C to peak temperature	6 minutes max.	

## Package Reflow Conditions

pkg. thickness ≥ 2.5mm and all bgas	pkg. thickness < 2.5mm and pkg. volume ≥ 350 mm <sup>3</sup>	pkg. thickness < 2.5mm and pkg. volume < 350mm <sup>3</sup>
Convection 220 +5/-0 °C		Convection 235 +5/-0 °C
VPR 215-219 °C		VPR 235 +5/-0 °C
IR/Convection 220 +5/-0 °C		IR/Convection 235 +5/-0 °C

## Reliability test program

Test item	Method	Description
SOLDERABILITY	MIL-STD-883D-2003	245°C, 5 SEC
HOLT	MIL-STD 883D-1005.7	1000 Hrs Bias @ 125°C
PCT	JESD-22-B, A102	168 Hrs, 100% RH, 121°C
TST	MIL-STD 883D-1011.9	-65°C ~ 150°C, 200 Cycles

## Carrier Tape & Reel Dimensions

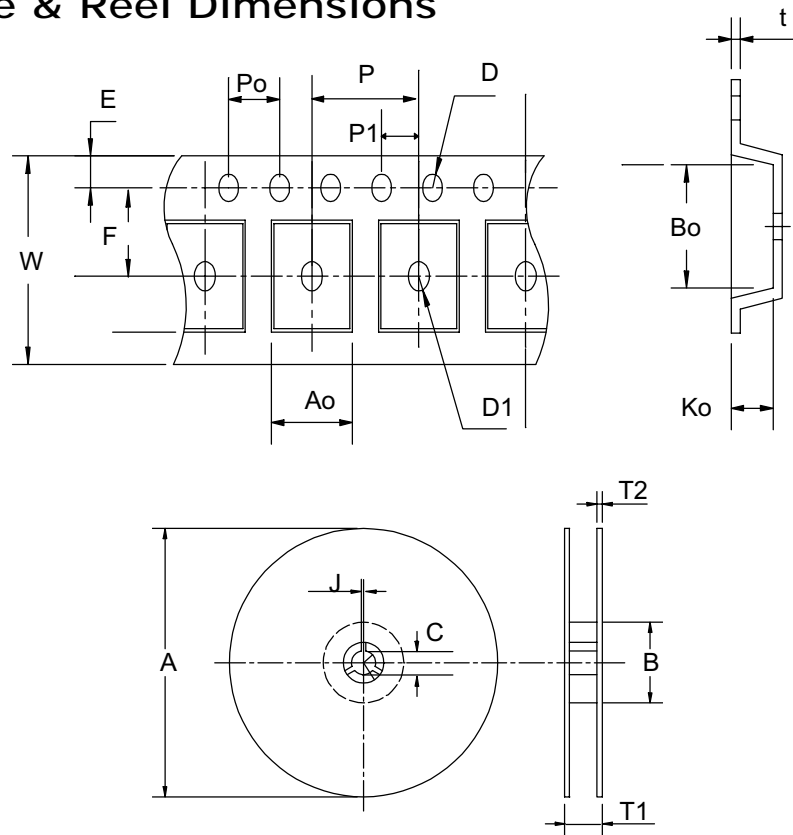

Application	A	B	C	J	T1	T2	W	P	E
SOP-8	330 ± 1	62 +1.5	12.75+ 0.15	2 ± 0.5	12.4 ± 0.2	2 ± 0.2	12 ± 0.3	8 ± 0.1	1.75 ± 0.1
	F	D	D1	Po	P1	Ao	Bo	Ko	t
	5.5 ± 1	1.55 +0.1	1.55 + 0.25	4.0 ± 0.1	2.0 ± 0.1	6.4 ± 0.1	5.2 ± 0.1	2.1 ± 0.1	0.3 ± 0.013



## Cover Tape Dimensions

Application	Carrier Width	Cover Tape Width	Devices Per Reel
SOP- 8	12	9.3	2500

## Customer Service

### Anpec Electronics Corp.

Head Office :

5F, No. 2 Li-Hsin Road, SBIP,

Hsin-Chu, Taiwan, R.O.C.

Tel : 886-3-5642000

Fax : 886-3-5642050

Taipei Branch :

7F, No. 137, Lane 235, Pac Chiao Rd.,

Hsin Tien City, Taipei Hsien, Taiwan, R. O. C.

Tel : 886-2-89191368

Fax : 886-2-89191369