

FEATURES

- Output Current of 3A
- Fast Transient Response
- 0.04% Line Regulation
- 0.2% Load Regulation
- Internal Thermal and Current Limiting
- Adjustable or Fixed Output Voltage(1.5V, 1.8V, 2.5V, 3.3V, 5.0V)
- Surface Mount Package TO-263 3LD & TO-252 3L
- 100% Thermal Limit Burn-in
- Low Dropout Voltage 1.5V at 3A Output Current
- Moisture Sensitivity Level 3

APPLICATIONS

- High Efficiency Linear Regulators / Power Supply
- High Efficiency "Green" Computer Systems
- Constant Current Regulators
- Portable Instrumentation
- SMPS Post-Regulator
- Adjustable Power Supplies
- Powering VGA & Sound Card

DESCRIPTION

The LM1085 series of positive adjustable and fixed regulators are designed to provide 3A with high efficient. All internal circuitry is designed to operate down to 1.5V input to output differential. On-chip trimming adjusts the reference voltage to 1%. It's low dropout voltage and fast transient response make it ideal for low voltage microprocessor applications. Internal current and thermal limiting provides protection against any overload condition that would create excessive junction temperature.

TEST & TYPICAL APPLICATION CIRCUIT

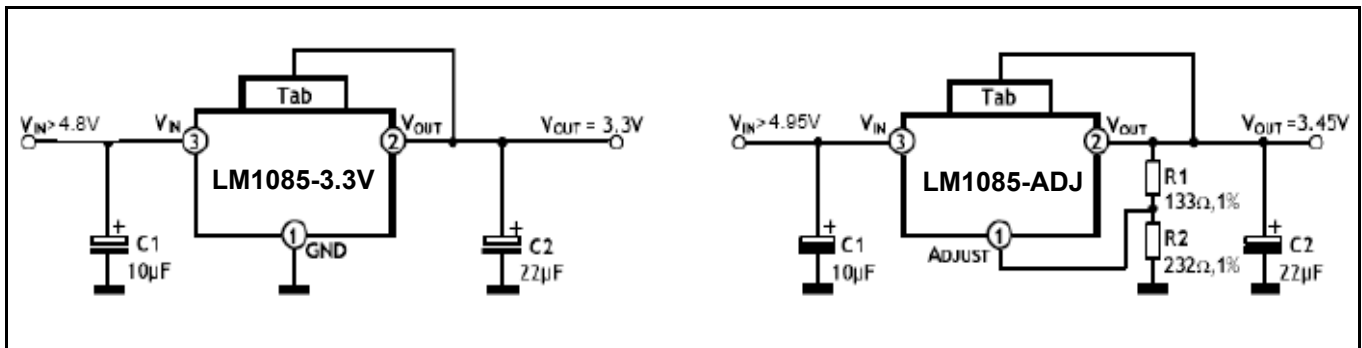

Note

- (1) C1 needed if device is far away from filter capacitors.
 (2) C2 minimum value required for stability

$$V_{REF} = V_{OUT} - V_{ADJ} = 1.25V(\text{Typ.}) \quad I_{ADJ} = 55\mu A(\text{Typ.})$$

$$V_{OUT} = V_{REF} \times (1 + R2/R1) + I_{ADJ} \times R2$$

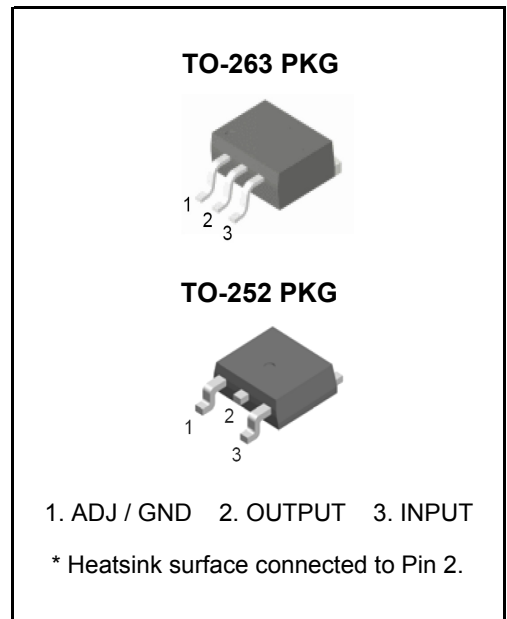

ORDERING INFORMATION

Device	Package
LM1085R-X.X	TO-263 3LD
LM1085RS-X.X	TO-252 3LD

(X.X=VOUT=1.5V, 1.8V, 2.5V, 3.3V, 5.0V, ADJ)

BLOCK DIAGRAM

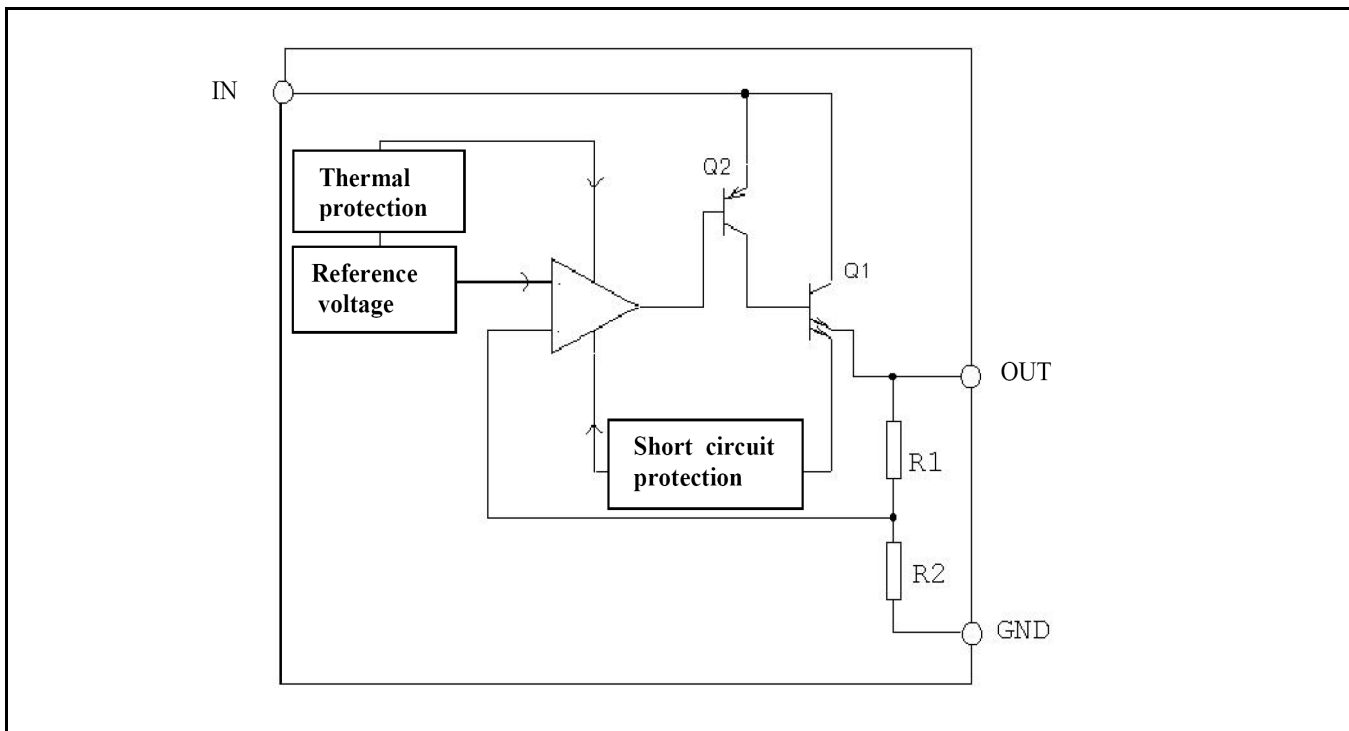

ABSOLUTE MAXIMUM RATINGS

CHARACTERISTIC	SYMBOL	VALUE	UNIT
Supply Voltage	V_{IN}	12	V
Operating Temperature Range	T_A	-10 ~ 70	°C
Junction Temperature	T_J	0 ~ 125	°C
Storage Temperature Range	T_{stg}	-65 ~ 150	°C
Thermal Resistance Junction to Case TO-263	T_{jc}	3	C/W
Thermal Resistance Junction to Ambient TO-263	T_{ja}	60	C/W
Lead Temperature (Soldering) 10 sec.	T_{sol}	300	°C
Maximum Output Current	I_{max}	3	A

3A L.D.O. VOLTAGE REGULATOR (Adjustable & Fixed)

LM1085

ELECTRICAL CHARACTERISTICS $I_{OUT}=100mA$, $T_A=25^{\circ}C$, unless otherwise specified

PARAMETER	TEST CONDITIONS	MIN	TYP	MAX	UNIT
1.5V Version					
Output Voltage	$0 < I_{OUT} < 3A$, $2.75V < V_{IN}$	1.470	1.5	1.530	V
1.8V Version					
Output Voltage	$0 < I_{OUT} < 3A$, $2.75V < V_{IN}$	1.764	1.8	1.836	V
2.5V Version					
Output Voltage	$0 < I_{OUT} < 3A$, $3.5V < V_{IN}$	2.450	2.5	2.550	V
3.3V Version					
Output Voltage	$0 < I_{OUT} < 3A$, $4.75V < V_{IN}$	3.234	3.3	3.366	V
5.0V Version					
Output Voltage	$0 \leq I_{OUT} \leq 3A$, $5.5V \leq V_{IN}$	4.900	5.0	5.100	V
All Voltage Options					
Reference Voltage (V_{REF})	$V_{IN} \leq 7V$, $P \leq P_{MAX}$	1.238	1.25	1.263	V
	$1.5V \leq (V_{IN} - V_{OUT}) \leq 5.75V$, $10mA \leq I_{OUT} \leq 3A$	1.225	1.25	1.275	
Min. Load Current(Note 3)	$1.5V \leq (V_{IN} - V_{OUT}) \leq 5.75V$		5	13	mA
Line Regulation ($\Delta V_{REF}(V_{IN})$)	$2.75V \leq V_{IN} \leq 7V$, $I_{OUT}=10mA$, $T_J=25^{\circ}C$		0.05	0.3	%
Load Regulation ($\Delta V_{REF}(V_{OUT})$)	$10mA \leq I_{OUT} \leq 3A$, $(V_{IN} - V_{OUT})=3V$, $T_J=25^{\circ}C$		0.1	0.4	%
Dropout Voltage	$\Delta V_{REF}=1\%$, $I_{OUT}=3A$		1.3	1.5	V
Current Limit $I_{OUT}(MAX)$	$V_{IN} - V_{OUT}=3V$	3.2	4.5		A
	$1.4V \leq (V_{IN} - V_{OUT})$ Adjustable Only				
Long Term Stability	$T_A=125^{\circ}C$, 1000Hrs		0.3	1	%
Thermal Regulation ($\Delta V_{OUT}(Pwr)$)	$T_A=25^{\circ}C$, 30ms pulse		0.01	0.02	%/W
Output Noise, RMS	10Hz to 10KHz $T_A=25^{\circ}C$	0.003			%/Vo
Thermal Resistance	Junction to Tab			3	$^{\circ}C/W$
	Junction to Ambient			60	

TYPICAL PERFORMANCE CHARACTERISTICS

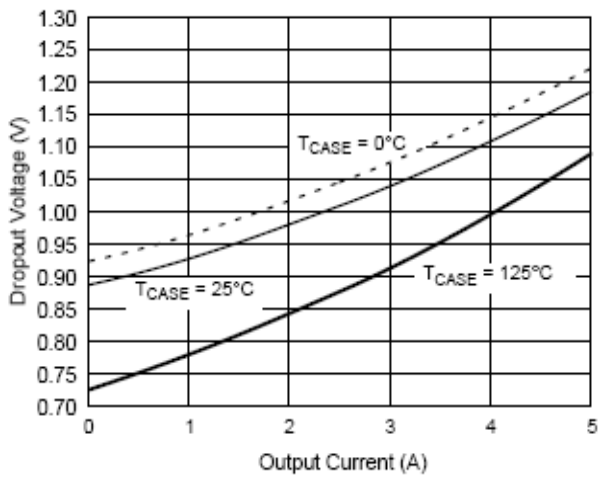

Figure 1. Dropout Voltage vs Output Current

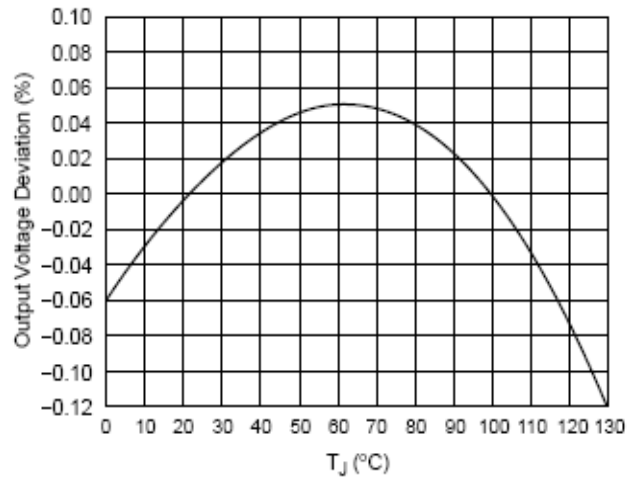

Figure 2. Reference Voltage vs Temperature

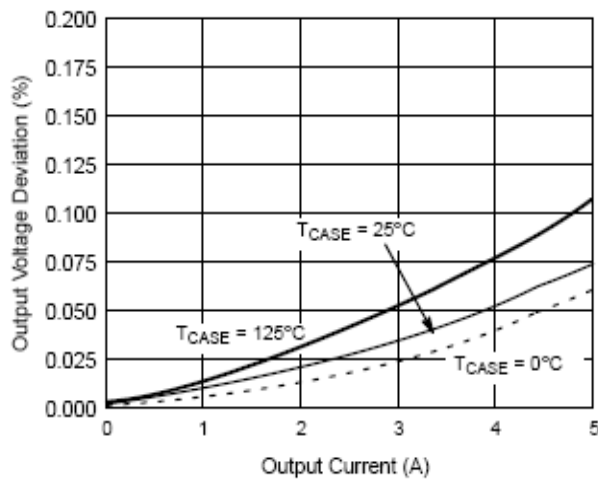

Figure 3. Load Regulation vs. Output Current

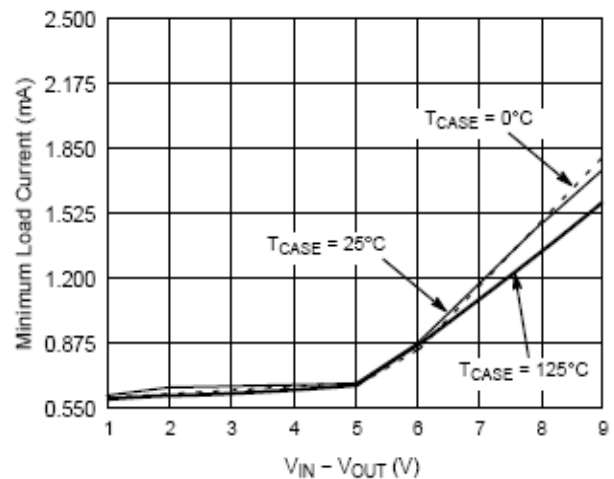

Figure 4. Minimum Load Current

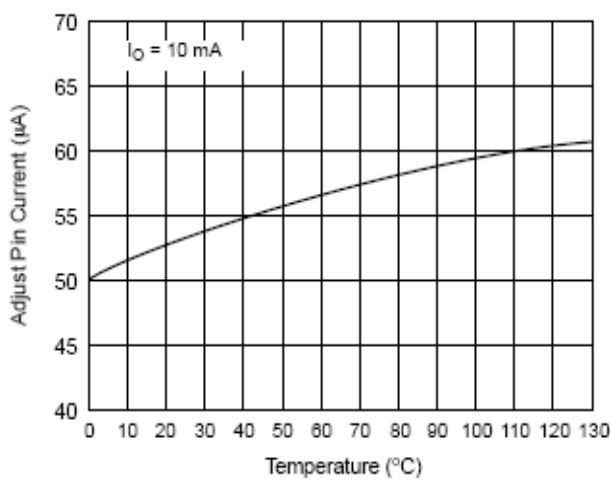

Figure 5. Adjust Pin Current vs Temperature

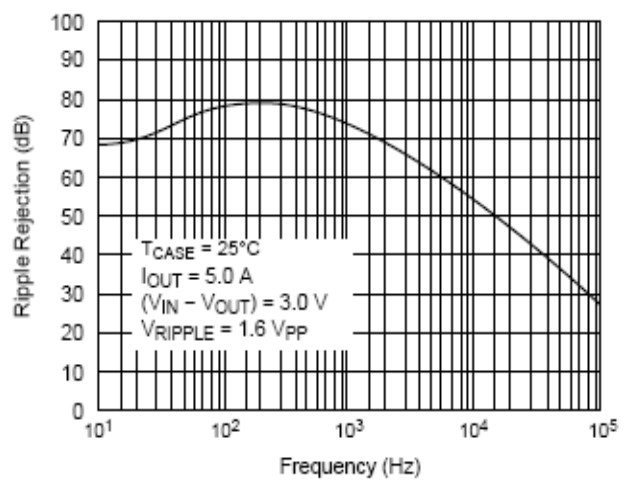

Figure 6. Ripple Rejection vs. Frequency (Fixed Versions)

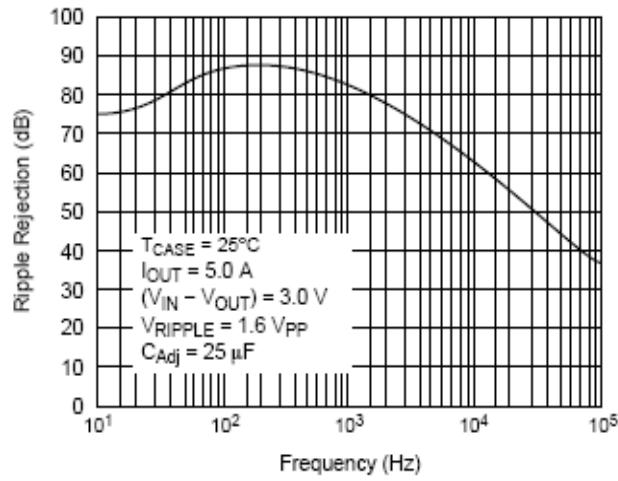

Figure 7. Ripple Rejection vs. Frequency (Adjustable Versions)

APPLICATIONS INFORMATION

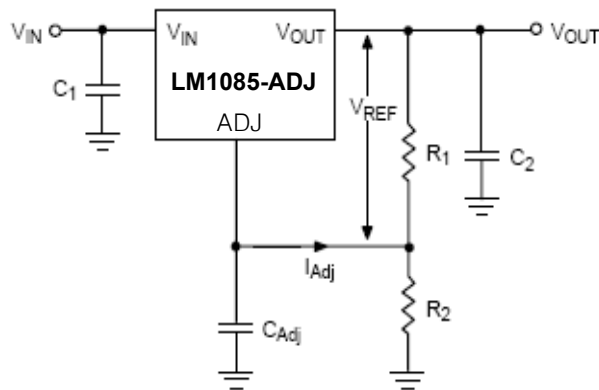

Figure 8. Resistor Divider Scheme for the Adjustable Version

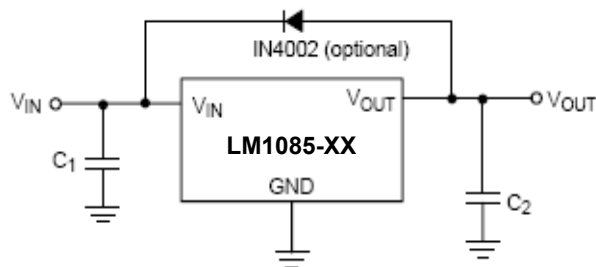

Figure 9. Protection Diode Scheme for Fixed Output Regulators

APPLICATION INFORMATION

The LM1085 series of adjustable and fixed regulators are easy to use and have all the protection features expected in high performance voltage regulators : short circuit protection and thermal shut-down. Pin compatible with older three terminal adjustable regulators, these devices offer the advantage of a lower dropout voltage, more precies reference tolerance and improved reference stability with temperature.

STABILITY

The circuit design used in the LM1085 series requires the use of an output capacitor as part of the device frequency compensation.

The addition of 150uF aluminum electrolytic or a 22uF solid tantalum on the output will ensure stability for all operating conditions. When the adjustment terminal is bypassed with a capacitor to improve the ripple rejection, the requirement for an output capacitor increases. The value of 22uF tantalum or 150uF aluminum covers all cases of bypassing the adjustment terminal. Without bypassing the adjustment terminal smaller capacitors can be used with equally good results.

To ensure good transient response with heavy load current changes capacitor values on the order of 100uF are used in the output of many regulators. To further improve stability and transient response of these devices larger values of output capacitor can be used.

PROTECTION DIODES

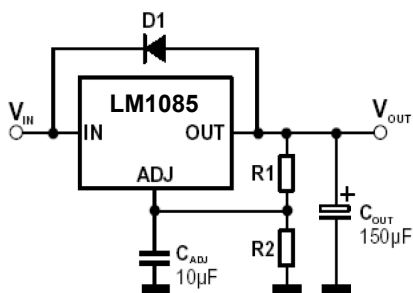

Figure 10.

Unlike older regulators, the LM1085 family does not need any protection diodies between the adjustment pin and the output and from the output tu the input to prevent over-stressing the die.

Internal resistors are limiting the internal current paths on the LM1085 adjustment pin, therefore even with capacitors on the adjustment pin no protection diode is needed to ensure device safety under short-circuit conditions.

Diodes between the input and output are not usually needed.

Microsecond surge currents of 50A to 100A can be handled by the internal diode between the input and output pins of the device. In norminal operations it is difficult to get those values of surge currents even with the use of large output capacitances. If high value output capacitors are used, such as 1000uF to 5000uF and the input pin is instantaneously shorted to ground, damage can occur. A diode from output to input is recommended, when a crowbar circuit at the input of the LM1085 is used. Normal power supply cycling or even plugging and unplugging in the system will not generate current large enough to do any damage.

The adjustment pin can be driven on a transient basis $\pm 25V$, with respect to the output without any device degradation. As with any IC regulator, none the protection circuitry will be functional and the internal transistors will break dwin if the maximum inout to output voltage differential is exceeded.

RIPPLE REJECTION

The ripple rejection values are measured with the adjustment pin bypassed. The impedance of the adjust pin capacitor at the ripple frequency should be less than the value of R1 (normally 100Ω to 120Ω) for a proper bypassing and ripple rejection approaching the values shown. The size of the required adjust pin capacitor is a function of the input ripple frequency. If R1=100Ω at 120Hz the adjust pin capacitor should be 25uF. At 100kHz only 0.22uF is needed.

The ripple rejection will be a function of output voltage, in circuits without an adjust pin bypass capacitor. The output ripple will increase directly as a ratio of the output voltage to the reference voltage (V_{OUT}/V_{REF})

OUTPUT VOLTAGE

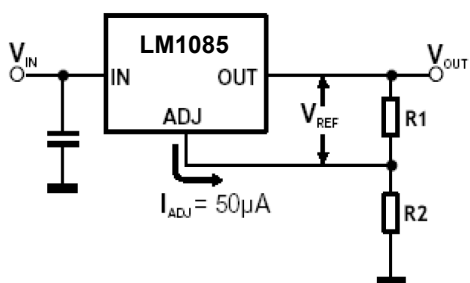

Figure 11.

The LM1085 series develops a 1.25V reference voltage between the output and the adjust terminal. Placing a resistor between these two terminals causes a constant current to flow through R1 and down through R2 to set the overall output voltage.

This current is normally the specified minimum load current of 10mA. Because I_{ADJ} is very small and constant it represents a small error and it can usually be ignored.

LOAD REGULATION

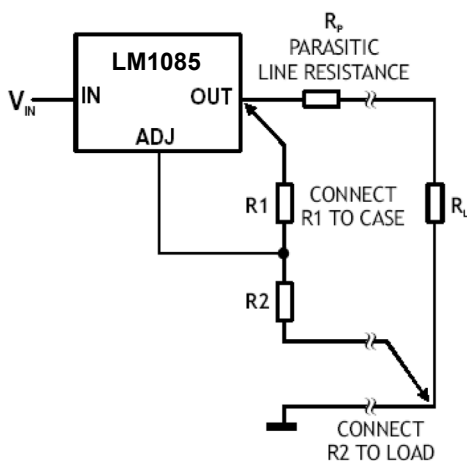

Figure 12.

True remote sheet specification it is not possible to provide, because the LM1085 is a three terminal device.

The resistance of the wire connecting the regulator to the load will limit the load regulation.

The data sheet specification for load regulation is measured at the bottom of the package. Negative side sensing is a true Kelvin connection, with the bottom of the output divider returned to the negative side of the load.

The best load regulation is obtained when the top of the resistor divider R1 is connected directly to the case not to the load. If R1 were connected to the load, the effective resistance between the regulator and the load would be:

$$[R_p \times (R_2 + R_1)] / R_1, R_p = \text{Parasitic Line Resistance}$$

Connected as shown Figure.12 R_p is not multiplied by the divider ratio. Using 16-gauge wire the parasitic line resistance is about 0.004Ω per foot, translating to 4mV/ft at 1A load current.

THERMAL CONSIDERATIONS

The LM1085 series have internal power and thermal limiting circuitry designed to protect the device under overload conditions. However maximum junction temperature ratings should not be exceeded under continuous normal load conditions.

Careful consideration must be given to all sources of thermal resistance from junction to ambient, including junction-to-case, case-to-heat sink interface and heat sink resistance itself. To ensure safe operating temperatures and reflect more accurately the device temperature, new thermal resistance specifications have been developed. Unlike older regulators with a single junction-to-case thermal resistance specification, the data section for these new regulators provides a separate thermal resistance and maximum junction temperature for both the Control Section and the Power Transistor. Calculations for both temperatures under certain conditions of ambient temperature and heat sink resistance and to ensure that both thermal limits are met.

Junction-to-case thermal resistance is specified from the IC junction to the bottom of the case directly below the die. This is the lowest resistance path for the heat flow. In order to ensure the best possible thermal flow from this area of the package to the heat sink proper mounting is required. Thermal compound at the case-to-heat sink interface is recommended. A thermally conductive spacer can be used, if the case of the device must be electrically isolated, but its added contribution to thermal resistance has to be considered. A thermally conductive spacer can be used, if the case of the device must be electrically isolated, but its added contribution to thermal resistance has to be considered.