

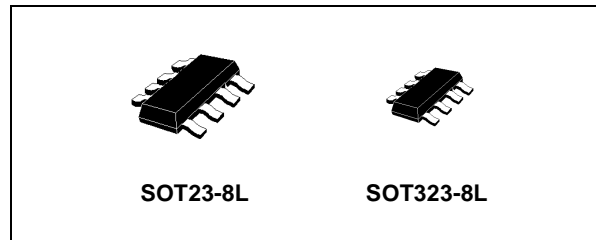

DUAL HIGH SPEED BUS SWITCH

- HIGH SPEED: $t_{PD} = 0.5ns$ (TYP.) at $V_{CC} = 5V$
- LOW POWER DISSIPATION:
 $I_{CC} = 1\mu A$ (MAX.) at $T_A=25^\circ C$
- LOW "ON" RESISTANCE at $V_{CC}=5.0V$:
 $R_{ON} = 7\Omega$ (TYP), $V_{IN}=0V$, $I_{I/O}=30mA$
 $R_{ON} = 20\Omega$ (TYP), $V_{IN}=2.4V$, $I_{I/O}=10mA$
- OPERATING VOLTAGE RANGE:
 V_{CC} (OPR.) = 3.0V TO 5.5V
- 5V TOLERANT ON CONTROL PIN
- HIGH NOISE IMMUNITY:
 $V_{NIH} = V_{NIL} = 28\% V_{CC}$ (MIN.)



DESCRIPTION

The 74V2G384 is an advanced high-speed CMOS DUAL HIGH SPEED BUS SWITCH fabricated in silicon gate C²MOS technology. It's designed to operate from 3V to 5.5V, making this device ideal for portable applications. It offers 7Ω Resistance typical value at $V_{CC}=4.5V$. Additional key features are fast switching speed ($t_{ON}=3.8ns$, $t_{OFF}=3.3ns$ Typical) and Low Power Consumption.

The OE input is provided to control the switch; the switch is ON when the \overline{OE} input is held low and OFF when \overline{OE} is held high.

ORDER CODES

PACKAGE	T & R
SOT23-8L	74V2G384STR
SOT323-8L	74V2G384CTR

It's available in the commercial and extended temperature range in SOT23-8L and SC-70-8L package.

PIN CONNECTION AND IEC LOGIC SYMBOLS

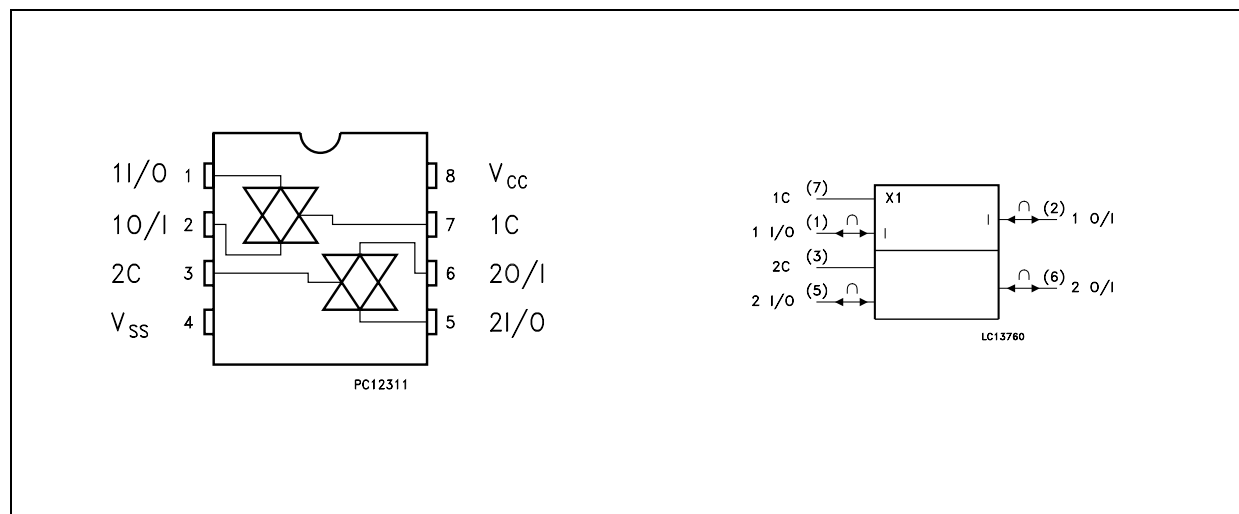

INPUT EQUIVALENT CIRCUIT

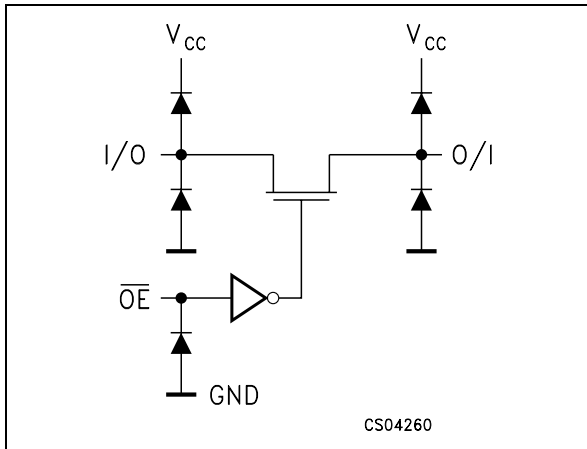

PIN DESCRIPTION

PIN No	SYMBOL	NAME AND FUNCTION
1, 5	1I/O, 2I/O	Independent Input/Output
2, 6	1O/I, 2O/I	Independent Output/Input
7, 3	$\overline{1OE}$, $\overline{2OE}$	Enable Input (Active HIGH)
4	GND	Ground (0V)
8	V _{CC}	Positive Supply Voltage

TRUTH TABLE

\overline{OE}	SWITCH FUNCTION
L	ON
H	OFF *

* High Impedance State

ABSOLUTE MAXIMUM RATINGS

Symbol	Parameter	Value	Unit
V _{CC}	Supply Voltage	-0.5 to +7.0	V
V _I	DC Input Voltage	-0.5 to V _{CC} + 0.5	V
V _{IC}	DC Control Input Voltage	-0.5 to +7.0	V
V _O	DC Output Voltage	-0.5 to V _{CC} + 0.5	V
I _{IK}	DC Input Diode Current	± 20	mA
I _{IK}	DC Control Input Diode Current	- 20	mA
I _{OK}	DC Output Diode Current	± 20	mA
I _O	DC Output Current	± 50	mA
I _{CC} or I _{GND}	DC V _{CC} or Ground Current	± 50	mA
T _{stg}	Storage Temperature	-65 to +150	°C
T _L	Lead Temperature (10 sec)	300	°C

Absolute Maximum Ratings are those values beyond which damage to the device may occur. Functional operation under these conditions is not implied.

RECOMMENDED OPERATING CONDITIONS

Symbol	Parameter	Value	Unit
V _{CC}	Supply Voltage	3 to 5.5	V
V _I	Input Voltage	0 to V _{CC}	V
V _{IC}	Control Input Voltage	0 to 5.5	V
V _O	Output Voltage	0 to V _{CC}	V
T _{op}	Operating Temperature	-55 to 125	°C
dt/dv	Input Rise and Fall Time (note 1) V _{CC} = 5.0V	0 to 20	ns/V

1) V_{IN} from 30% to 70% of V_{CC} on control pin

DC SPECIFICATIONS

Symbol	Parameter	Test Condition		Value						Unit	
		V _{CC} (V)		T _A = 25°C			-40 to 85°C		-55 to 125°C		
				Min.	Typ.	Max.	Min.	Max.	Min.		Max.
V _{IH}	High Level Input Voltage	2.0		1.5			1.5		1.5		V
		3.0 to 5.5		0.7V _{CC}			0.7V _{CC}		0.7V _{CC}		
V _{IL}	Low Level Input Voltage	2.0				0.5		0.5		0.5	V
		3.0 to 5.5				0.3V _{CC}		0.3V _{CC}		0.3V _{CC}	
R _{ON}	ON Resistance	3.0	V _{IC} = V _{IL} V _{I/O} = GND I _{I/O} ≤ 30 mA		9			13		20	Ω
		4.5	V _{IC} = V _{IL} V _{I/O} = GND I _{I/O} ≤ 30 mA		7			10		15	Ω
R _{ON}	ON Resistance	3.0	V _{IC} = V _{IL} V _{I/O} = 1.5V I _{I/O} ≤ 10 mA		32			60		80	Ω
		4.5	V _{IC} = V _{IL} V _{I/O} = 2.4V I _{I/O} ≤ 10 mA		20			40		60	Ω
I _{OFF}	Input/Output Leakage Current (SWITCH OFF)	5.5	V _{OS} = V _{CC} to GND V _{IS} = V _{CC} to GND V _{IC} = V _{IH}			±0.1		± 1		± 10	μA
I _{IN}	Control Input Leakage Current	0 to 5.5	V _{IC} = 5.5V or GND			± 0.1		± 1.0		± 1.0	μA
I _{CC}	Quiescent Supply Current	5.5	V _I = V _{CC} or GND			1		10		20	μA

AC ELECTRICAL CHARACTERISTICS (C_L = 50pF, Input t_r = t_f = 3ns)

Symbol	Parameter	Test Condition		Value						Unit	
		V _{CC} (V)		T _A = 25°C			-40 to 85°C		-55 to 125°C		
				Min.	Typ.	Max.	Min.	Max.	Min.		Max.
t _{PD}	Delay Time	3.3 ^(*)	t _r = t _f = 6ns		0.8	1.2		1.5		2.0	ns
		5.0 ^(**)	t _r = t _f = 6ns		0.5	0.8		1.0		1.5	
t _{PLZ} t _{PHZ}	Output Disable Time	3.3 ^(*)	R ₁ = 500Ω V _{IN} = 1.5V		8.5	12.0		14.0		16.0	ns
		5.0 ^(**)	R ₁ = 500 Ω V _{IN} = 2.4V		3.8	6.5		9.0		10.0	
t _{PZL} t _{PZH}	Output Enable Time	3.3 ^(*)	R ₁ = 1KΩ V _{IN} = 1.5V		7.3	12.0		14.0		16.0	ns
		5.0 ^(**)	R ₁ = 1KΩ V _{IN} = 2.4V		3.3	5.0		7.5		8.5	

(*) Voltage range is 3.3V ± 0.3V

(**) Voltage range is 5.0V ± 0.5V

CAPACITIVE CHARACTERISTICS

Symbol	Parameter	Test Condition		Value						Unit	
				T _A = 25°C			-40 to 85°C		-55 to 125°C		
		V _{CC} (V)		Min.	Typ.	Max.	Min.	Max.	Min.		Max.
C _{IN}	Input Capacitance				4	10		10		10	pF
C _{I/O}	Output Capacitance				7						pF
C _{PD}	Power Dissipation Capacitance (note 1)	3.3			2.5						pF
		5.0			3						

1) C_{PD} is defined as the value of the IC's internal equivalent capacitance which is calculated from the operating current consumption without load. (Refer to Test Circuit). Average operating current can be obtained by the following equation. $I_{CC(opr)} = C_{PD} \times V_{CC} \times f_{IN} + I_{CC}$

SOT23-8L MECHANICAL DATA

DIM.	mm.			mils		
	MIN.	TYP	MAX.	MIN.	TYP.	MAX.
A	0.90		1.45	35.4		57.1
A1	0.00		0.15	0.0		5.9
A2	0.90		1.30	35.4		51.2
b	0.22		0.38	8.6		14.9
C	0.09		0.20	3.5		7.8
D	2.80		3.00	110.2		118.1
E	2.60		3.00	102.3		118.1
E1	1.50		1.75	59.0		68.8
e	0	.65			25.6	
e1		1.95			76.7	
L	0.35		0.55	13.7		21.6

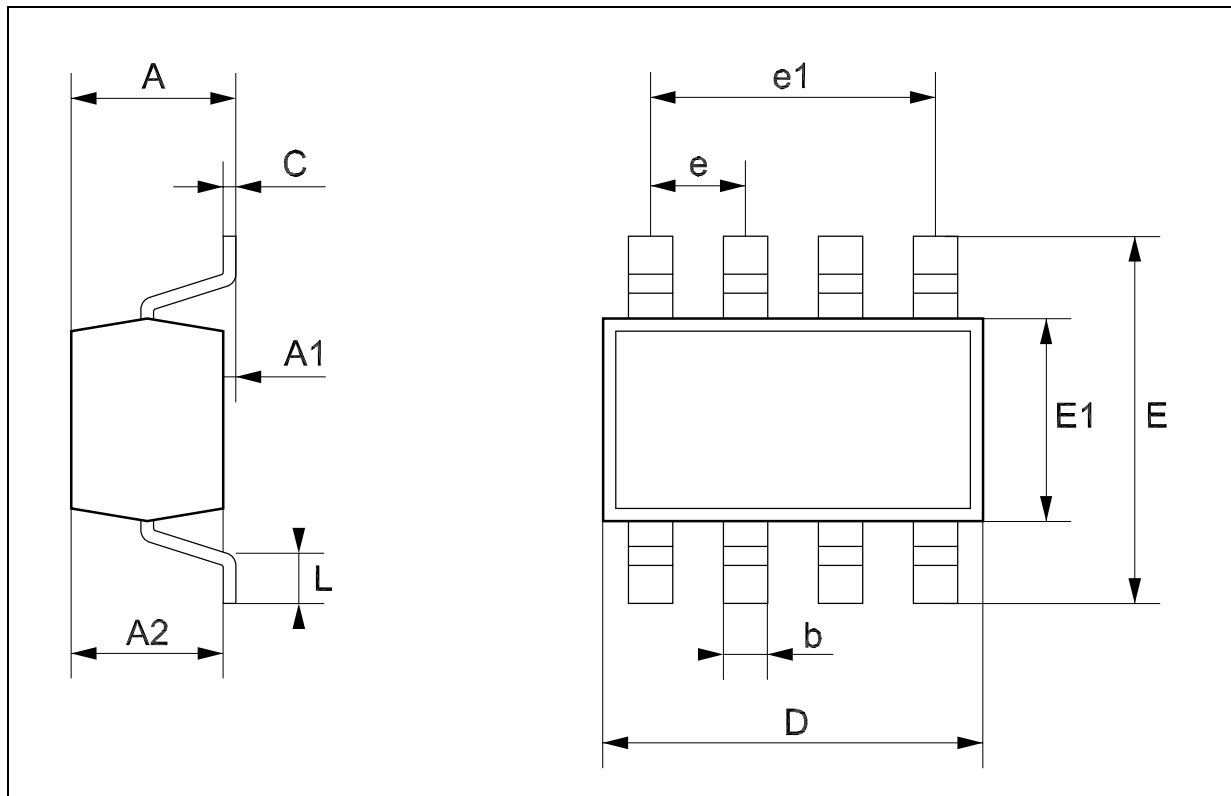

SOT323-8L MECHANICAL DATA

DIM.	mm.			mils		
	MIN.	TYP	MAX.	MIN.	TYP.	MAX.
A	0.80		1.10	31.5		43.3
A1	0.00		0.10	0.0		3.9
A2	0.80		1.00	31.5		34.9
b	0.13		0.28	5.1		11.0
C	0.10		0.18	3.9		7.1
D	1.80		2.20	70.9		86.6
E	1.80		2.40	70.9		94.5
E1	1.15		1.35	45.3		53.1
e		0.5			19.7	
e1		1.5			59.0	
L	0.10		0.30	3.9		11.8

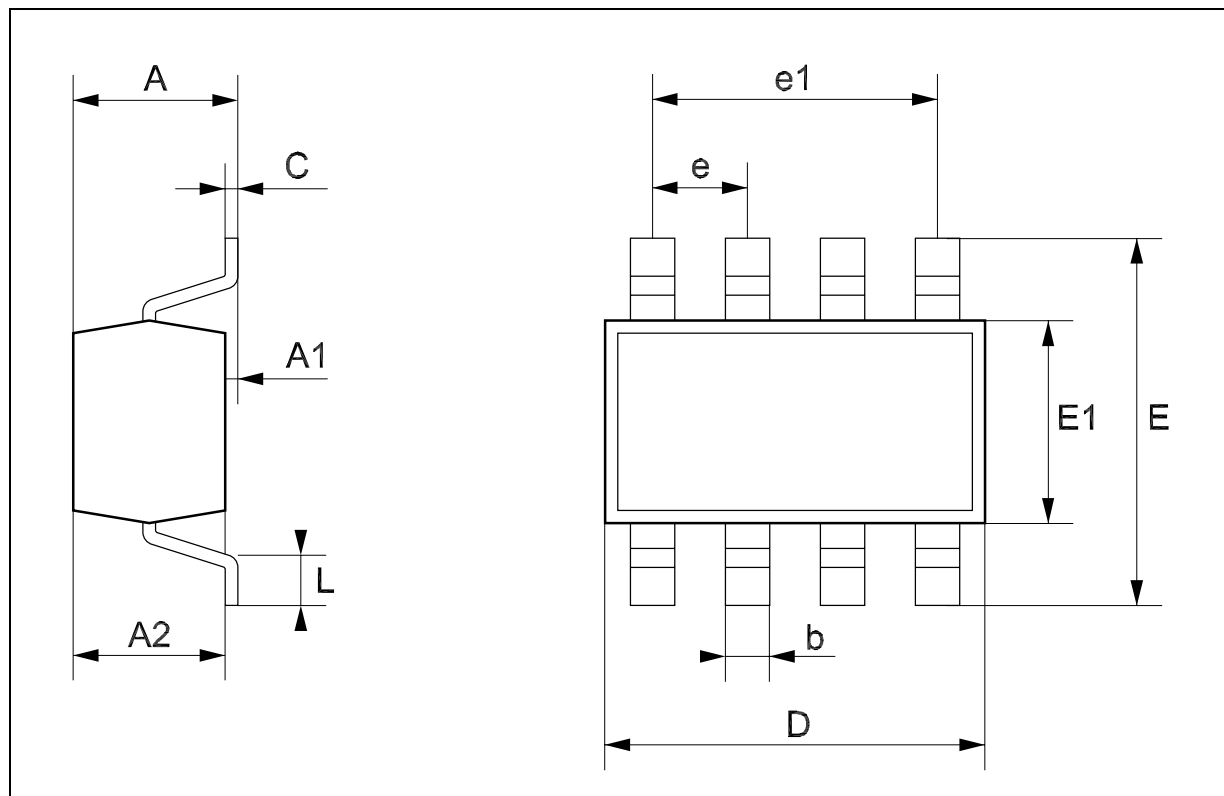

Tape & Reel SOT23-xL MECHANICAL DATA

DIM.	mm.			inch		
	MIN.	TYP	MAX.	MIN.	TYP.	MAX.
A			180			7.086
C	12.8	13.0	13.2	0.504	0.512	0.519
D	20.2			0.795		
N	60			2.362		
T			14.4			0.567
Ao	3.13	3.23	3.33	0.123	0.127	0.131
Bo	3.07	3.17	3.27	0.120	0.124	0.128
Ko	1.27	1.37	1.47	0.050	0.054	0.058
Po	3.9	4.0	4.1	0.153	0.157	0.161
P	3.9	4.0	4.1	0.153	0.157	0.161

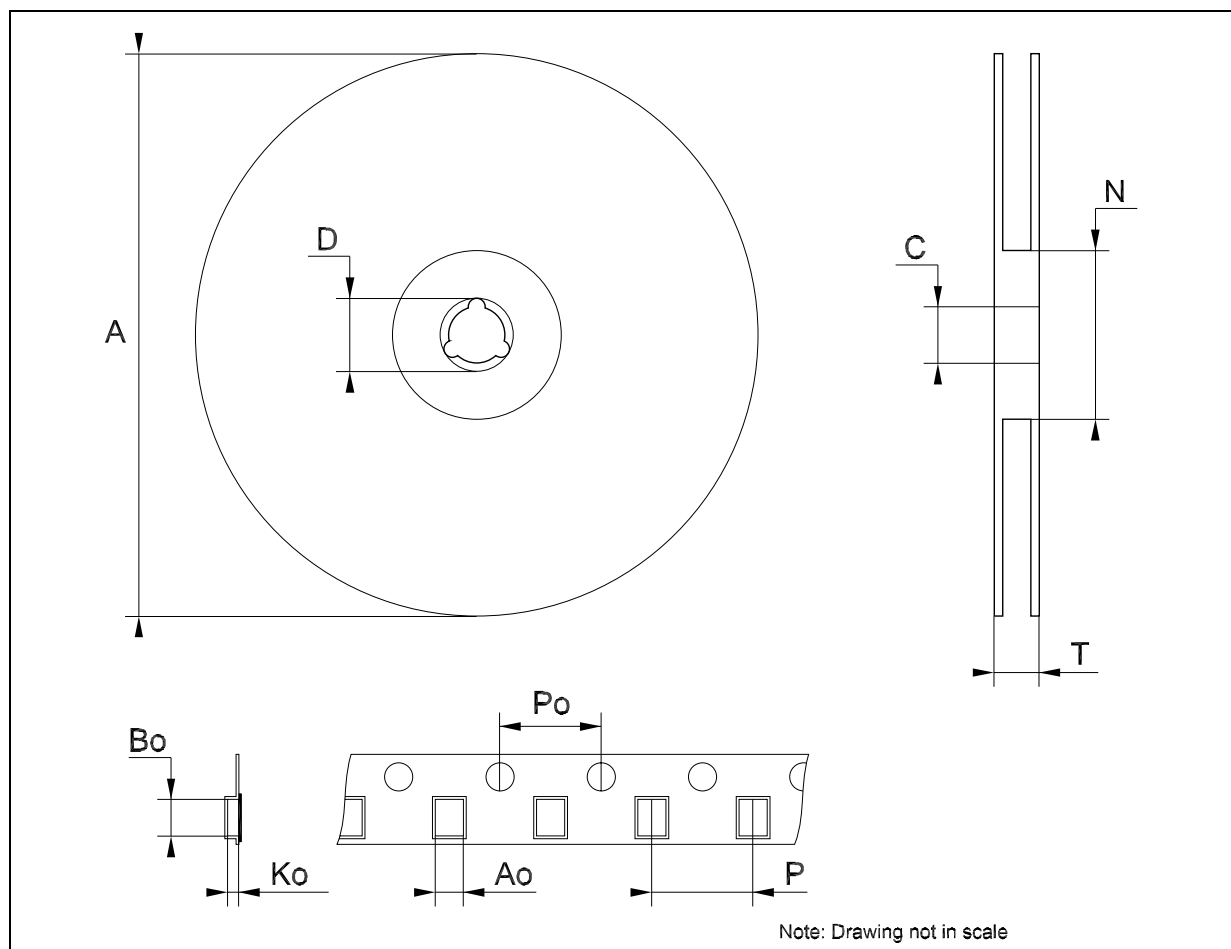

Tape & Reel SOT323-xL MECHANICAL DATA

DIM.	mm.			inch		
	MIN.	TYP	MAX.	MIN.	TYP.	MAX.
A	175	180	185	6.889	7.086	7.283
C	12.8	13	13.2	0.504	0.512	0.519
D	20.2			0.795		
N	59.5	60	60.5		2.362	
T			14.4			0.567
Ao		2.25			0.088	
Bo		2.7			0.106	
Ko		1.2			0.047	
Po	3.98	4	4.2	0.156	0.157	0.165
P	3.98	4	4.2	0.156	0.157	0.165

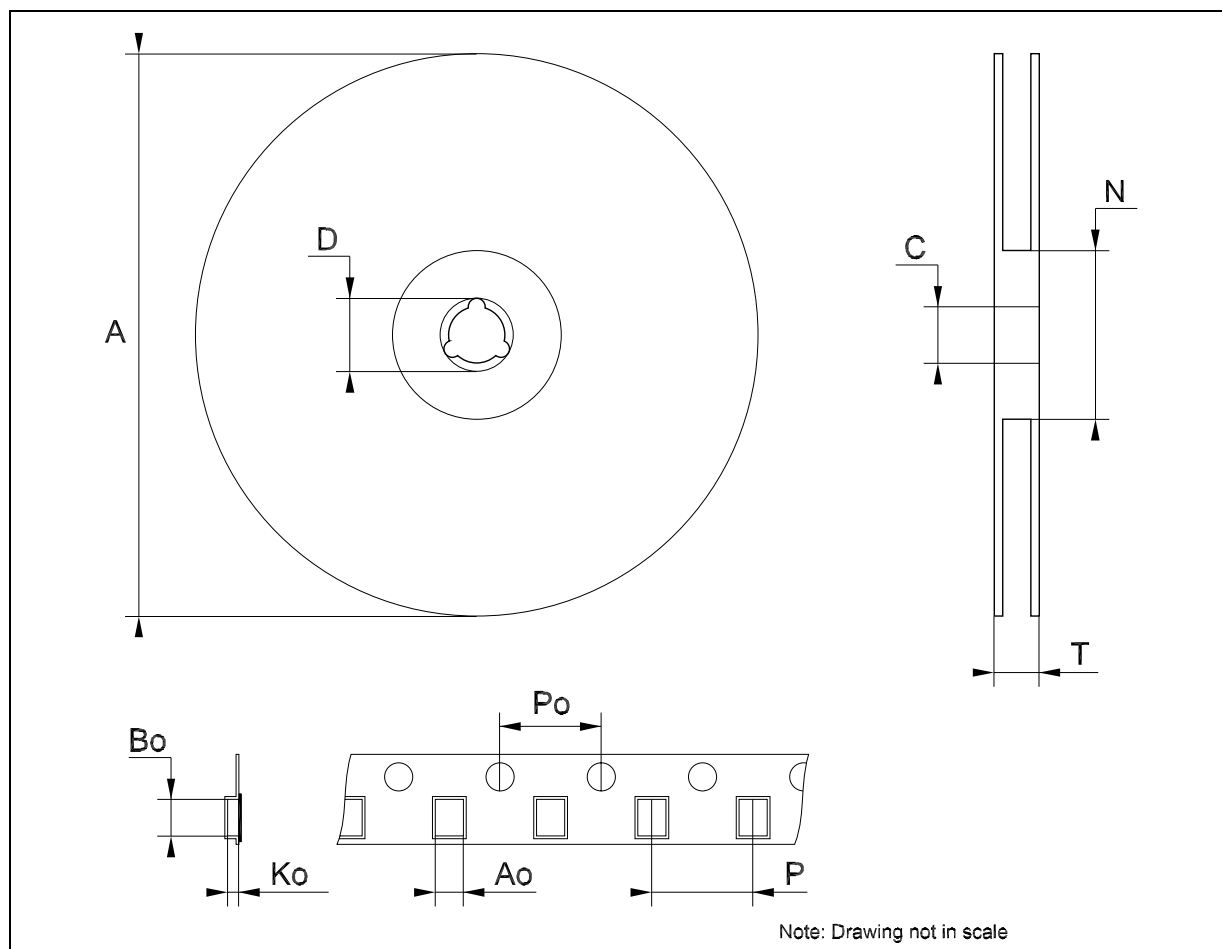

Information furnished is believed to be accurate and reliable. However, STMicroelectronics assumes no responsibility for the consequences of use of such information nor for any infringement of patents or other rights of third parties which may result from its use. No license is granted by implication or otherwise under any patent or patent rights of STMicroelectronics. Specifications mentioned in this publication are subject to change without notice. This publication supersedes and replaces all information previously supplied. STMicroelectronics products are not authorized for use as critical components in life support devices or systems without express written approval of STMicroelectronics.

© The ST logo is a registered trademark of STMicroelectronics

© 2002 STMicroelectronics - Printed in Italy - All Rights Reserved
STMicroelectronics GROUP OF COMPANIES

Australia - Brazil - Canada - China - Finland - France - Germany - Hong Kong - India - Israel - Italy - Japan - Malaysia - Malta - Morocco
Singapore - Spain - Sweden - Switzerland - United Kingdom - United States.

© <http://www.st.com>

