

4-bit REAL TIME CLOCK MODULE

# RTC-7301SF/DG

Product number (please refer to page 2)

Q4273018x000200

Q4273011x000200

- Built-in crystal oscillator 32.768 kHz with frequency adjusted
- Frequency selectable clock output (32.768 kHz to 1/30 Hz)
- Built-in 30 second adjustment function, digital pace adjustment function (Max. adjustment:  $\pm 192 \times 10^6$ )
- Built-in alarm and timer interrupt functions.
- Built-in semiconductor temperature sensor (Voltage output: -7.8 mV / °C, RTC-7301SF)
- Operating voltage range: 2.4 V to 5.5 V, time keeping voltage range: 1.6 V to 5.5 V
- Low current consumption (0.6  $\mu$ A / 3 V Typ.)
- High speed parallel interface compatible with SRAM

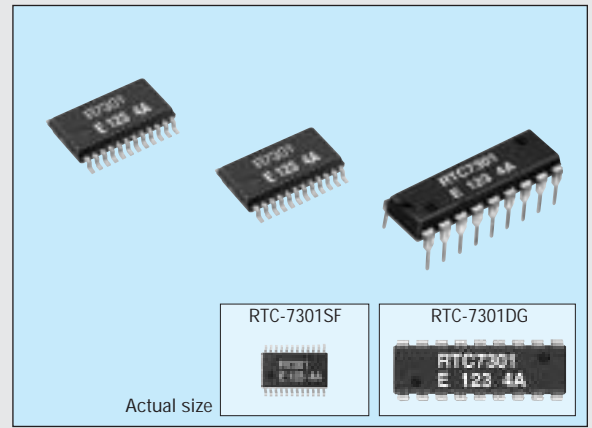

The details are mentioned in the application manual.

<http://www.epsondevice.com>

## Specifications (characteristics)

### Absolute Max. ratings

GND=0V

Item	Symbol	Condition	Min.	Max.	Unit
Supply voltage	V <sub>DD</sub>	V <sub>DD</sub> to GND	-0.3	+7.0	V
Input voltage	V <sub>IN</sub>	Input terminal, D0 to D3 pins	GND -0.3	V <sub>DD</sub> + 0.3	
Output voltage(1)	V <sub>OUT1</sub>	IRQ pin	GND -0.3	+8.0	V
Output voltage(2)	V <sub>OUT2</sub>	FOUT, D0-D3 pins, VTEMP pin	GND -0.3	V <sub>DD</sub> + 0.3	
Storage temperature	T <sub>STG</sub>	Stored as bare product after unpacking	-55	+125	°C

### Operating conditions

GND=0V

Item	Symbol	Condition	Min.	Max.	Unit
Power voltage	V <sub>DD</sub>	—	2.4	5.5	V
Clock voltage	V <sub>CLK</sub>	—	1.6	5.5	V
Operating temperature	T <sub>OPR</sub>	No condensation	-40	+85	°C

### Frequency characteristics

Item	Symbol	Condition	Range	Unit
Frequency precision	$\Delta f/f_0$	T <sub>a</sub> =+25 °C, V <sub>DD</sub> = 3.0 V	5 ± 23 *	x 10 <sup>-6</sup>
Oscillation start-up time	t <sub>STA</sub>	T <sub>a</sub> =+25 °C, V <sub>DD</sub> = 2.4 V	3 Max.	s
Frequency temperature characteristics	T <sub>OP</sub>	T <sub>a</sub> =-10 °C to +70 °C, V <sub>DD</sub> = 3.0 V	+10/-120	x 10 <sup>-6</sup>
Frequency voltage characteristics	f/V	T <sub>a</sub> =+25 °C, V <sub>DD</sub> = 1.6 V to 5.5V	±2	x 10 <sup>4</sup> /V
Aging	f <sub>a</sub>	T <sub>a</sub> =+25 °C, V <sub>DD</sub> = 3.0 V	±5	x 10 <sup>4</sup> /year

\* Please ask tighter tolerance

### DC characteristics

GND=0 V, V<sub>DD</sub>=1.6 V to 5.5 V, T<sub>a</sub>= -40 °C to +85 °C

Item	Symbol	Condition	Min.	Typ.	Max.	Unit
Current consumption (When non-accessed)	I <sub>DD1</sub>	V <sub>DD</sub> = 5 V	—	1.0	2.0	μA
		V <sub>DD</sub> = 3 V	—	0.6	1.0	μA

CS<sub>0</sub>, RD, WR = V<sub>DD</sub>  
A<sub>0</sub>-A<sub>3</sub>, CS<sub>1</sub> = GND  
D<sub>0</sub>-D<sub>3</sub>, IRQ = Hi-Z  
FOUT = Hi-Z (OFF)  
VTEMP = Hi-Z (OFF)

Note) There is no VTEMP pin on the RTC-7301DG so standards for the VTEMP pin within the conditions described above do not apply.

### Temperature sensor characteristics

GND=0 V, T<sub>a</sub>= -40 °C to +85 °C

Item	Symbol	Condition	Min.	Typ.	Max.	Unit
Temperature output voltage	VTEMP	T <sub>a</sub> = +25 °C, GND based output voltage VTEMP pins, V <sub>DD</sub> =2.7 V to 5.5 V		1.470		V
Output precision	T <sub>ACR</sub>	T <sub>a</sub> = +25 °C, V <sub>DD</sub> =2.7 V to 5.5 V			±5.0	°C
Temperature sensitivity	V <sub>SE</sub>	-40 °C ≤ T <sub>a</sub> ≤ +85 °C, V <sub>DD</sub> =2.7 V to 5.5 V	-7.3	-7.8	-8.3	mV/°C
Linearity	$\Delta$ NL	-40 °C ≤ T <sub>a</sub> ≤ +85 °C, V <sub>DD</sub> =2.7 V to 5.5 V			±2.0	%
Temperature detection range	T <sub>SOP</sub>	$\Delta$ NL ≤ ± 2.0 %, V <sub>DD</sub> =2.7 V to 5.5 V	-40		+85	°C
Output resistance	R <sub>o</sub>	T <sub>a</sub> = +25 °C, VTEMP pins, V <sub>DD</sub> =2.7 V to 5.5 V GND standard and V <sub>DD</sub> standard		1.0	3.0	kΩ
Load condition	C <sub>L</sub>	V <sub>DD</sub> =2.7 V to 5.5 V			100	pF
	R <sub>L</sub>	V <sub>DD</sub> =2.7 V to 5.5 V	500			kΩ
Response time	t <sub>RESP</sub>	V <sub>DD</sub> =3.3 V, C <sub>L</sub> =50 pF, R <sub>L</sub> =500 kΩ, Max. ±1 °C			200	μs

Note) There is no temperature sensor function on the RTC-7301DG.

## Terminal connection

### RTC-7301SF

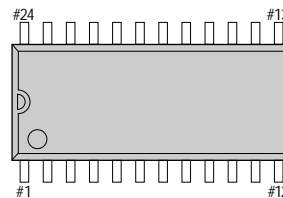

No.	Pin terminal	No.	Pin terminal
1	CS <sub>0</sub>	24	V <sub>DD</sub>
2	FOUT	23	(V <sub>DD</sub> )
3	FO <sub>2T</sub>	22	(V <sub>DD</sub> )
4	VTEMP	21	(V <sub>DD</sub> )
5	(V <sub>DD</sub> )	20	(V <sub>DD</sub> )
6	IRQ	19	(V <sub>DD</sub> )
7	A <sub>0</sub>	18	CS <sub>1</sub>
8	A <sub>1</sub>	17	D <sub>0</sub>
9	A <sub>2</sub>	16	D <sub>1</sub>
10	A <sub>3</sub>	15	D <sub>2</sub>
11	RD	14	D <sub>3</sub>
12	GND	13	WR

### RTC-7301DG

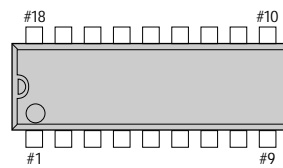

No.	Pin terminal	No.	Pin terminal
1	CS <sub>0</sub>	18	V <sub>DD</sub>
2	FOUT	17	(V <sub>DD</sub> )
3	IRQ	16	(V <sub>DD</sub> )
4	A <sub>0</sub>	15	CS <sub>1</sub>
5	A <sub>1</sub>	14	D <sub>0</sub>
6	A <sub>2</sub>	13	D <sub>1</sub>
7	A <sub>3</sub>	12	D <sub>2</sub>
8	RD	11	D <sub>3</sub>
9	GND	10	WR

• (V<sub>DD</sub>) and V<sub>DD</sub> are to have the same level of voltage. Do not connect it to any external terminals.

## External dimensions

(Unit: mm)

### RTC-7301SF (SSOP 24-pin)

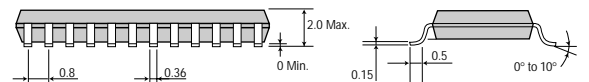
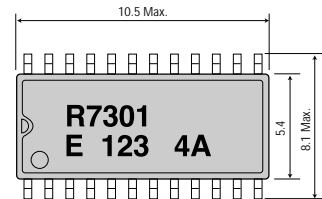

Metal may be exposed on the top or bottom of this product. This won't affect any quality, reliability or electrical spec.

### RTC-7301DG (DIP 18-pin)

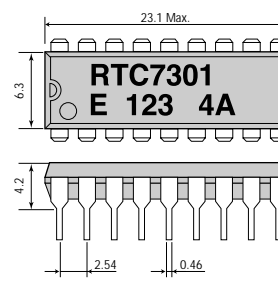

Register table

Bank0 Clock and calendar registers

Address	Register	bit 3	bit 2	bit 1	bit 0
0	1 second digit	8	4	2	1
1	10 second digit	Fos	40	20	10
2	1 minute digit	8	4	2	1
3	10 minute digit	o	40	20	10
4	1hour digit	8	4	2	1
5	10 hour digit	o	o	20	10
6	Day digit	o	4	2	1
7	1 day digit	8	4	2	1
8	10 day digit	o	o	20	10
9	1 month digit	8	4	2	1
A	10 month digit	o	o	o	10
B	1 year digit	8	4	2	1
C	10 year digit	80	40	20	10
D	100 year digit	800	400	200	100
E	1000 year digit	TEST	TEMP	2000	1000
F	Control registers	Bank Sel 1	Bank Sel 0	STOP	BUSY/ADJ

Bank1 Alarms and FOUT registers

Address	Register	bit 3	bit 2	bit 1	bit 0
0	1 second digit	8	4	2	1
1	10 second digit	AE	40	20	10
2	1 minute digit	8	4	2	1
3	10 minute digit	AE	40	20	10
4	1hour digit	8	4	2	1
5	10 hour digit	AE	•	20	10
6	Day digit	AE	4	2	1
7	1 day digit	8	4	2	1
8	10 day digit	AE	•	20	10
9	—	•	•	•	•
A	—	•	•	•	•
B	CS1 Controller	CTEMP	CDT_ON	•	•
C	FOUT divider ratio setting register	o	FD2	FD1	FD0
D	FOUT divider ratio setting register	FE	o	FD4	FD3
E	Alarm control	TEST	TEMP	AF	AIE
F	Control register	Bank Sel 1	Bank Sel 0	STOP	BUSY/ADJ

Bank2 Digital offset and timer registers

Address	Registers	bit 3	bit 2	bit 1	bit 0
0	Digital offset	DT3	DT2	DT1	DT0
1		DT_ON	DT6	DT5	DT4
2	—	o	o	o	o
3	—	o	o	o	o
4	Timer counter preset value	8	4	2	1
5		128	64	32	16
6	Timer counter data	8	4	2	1
7		128	64	32	16
8	Timer settings	TE	TI/TP	TD1	TD0
9	—	o	o	o	o
A	—	o	o	o	o
B	—	o	o	o	o
C	—	o	o	o	o
D	—	o	o	o	o
E	Timer control	TEST	TEMP	TF	TIE
F	Control register	Bank Sel 1	Bank Sel 0	STOP	BUSY/ADJ

Reading data

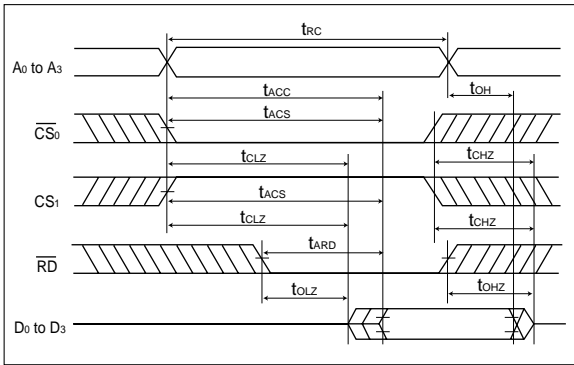

Writing data (CS Control)

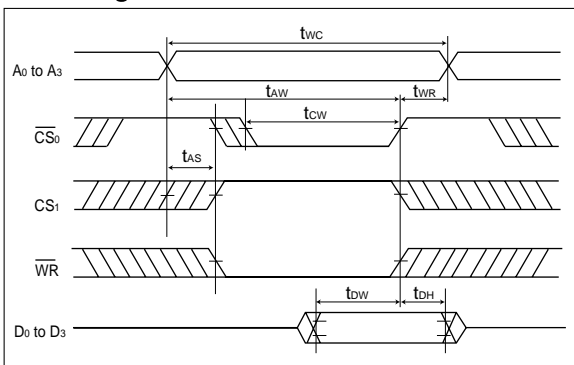

Writing data (WR Control)

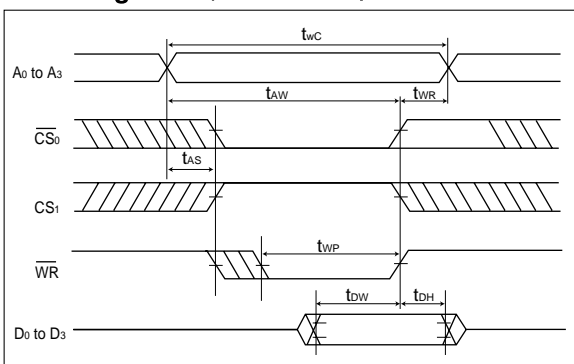

AC characteristics

\*GND=0 V, Ta=-40 °C to +85 °C •Input conditions: VI= 0.5 x VDD, VO= 0.5 x VDD •Output load: CL= 100 pF (IACC,IACS,IARD)

Item	Symbol	Condition	VDD=2.4 to 3.6 V		VDD=4.5 to 5.5 V		Unit
			Min.	Max.	Min.	Max.	
Read cycle time	t <sub>RC</sub>	—	150	—	85	—	ns
Address access time	t <sub>ACC</sub>	—	—	150	—	85	ns
CE access time	t <sub>ACS</sub>	—	—	150	—	85	ns
RD access time	t <sub>ARD</sub>	—	—	100	—	45	ns
CE output set time	t <sub>CLZ</sub>	—	5	—	3	—	ns
CE output floating	t <sub>CHZ</sub>	—	—	60	—	30	ns
RD output set time	t <sub>OLZ</sub>	—	5	—	3	—	ns
RD output floating	t <sub>OHZ</sub>	—	—	60	—	30	ns
Output hold time	t <sub>OH</sub>	—	10	—	5	—	ns
Write cycle time	t <sub>WC</sub>	—	150	—	85	—	ns
Chip select time	t <sub>CW</sub>	—	140	—	70	—	ns
Address valid end of write	t <sub>AW</sub>	—	140	—	70	—	ns
Address setup time	t <sub>AS</sub>	—	0	—	0	—	ns
Address hold time	t <sub>WR</sub>	—	0	—	0	—	ns
Write pulse width	t <sub>WP</sub>	—	130	—	65	—	ns
Input data set time	t <sub>DW</sub>	—	80	—	35	—	ns
Input data hold time	t <sub>DH</sub>	—	0	—	0	—	ns
FOUT output frequency duty	DUTY	FOUT= 32.768 kHz	40	60	40	60	%

Block diagram

