



## Next Generation RFID Reader Module

Based on WJC200 Gen2 RFID reader chipset

### Key Features

- Multi-protocol support: ISO 18000-6C (Gen2) & ISO 18000-6B
- Dynamic RF output power: +18 dBm to +30 dBm (1W) range
- Two antenna ports for added flexibility
- Power saving modes to extend battery life
- Supports Gen2 Dense Reader Environment (DRE)
- WJC200 Gen2 reader chipset based design

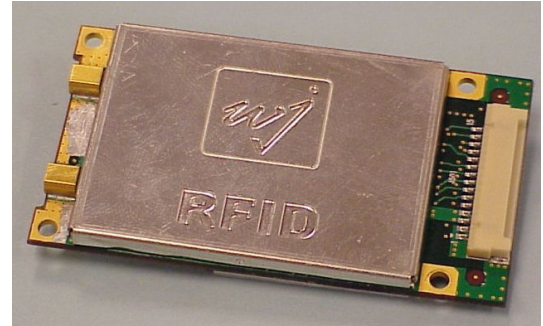

### Applications:

- Printers
- Item-level RFID
- Mobile & handheld devices
- Fixed readers

WJ Communication's WJM3000 UHF RFID module is designed to enable OEMs, System Integrators and VARs to offer RFID UHF Gen2 capability into new and existing short and long range applications such as printers, Mobile handheld and fixed readers. By leveraging WJ's WJC200 Gen2 chipset, the WJM3000 enables cost effective, compact RFID-enabled devices. The WJM3000 extends industry leading features including Gen2 dense reader environment (DRE). The WJM3000 reader module's simple but powerful command set allows for fast creation of custom applications via an open-source DLL and API.

The WJM3000 can be set to transmit a range of output powers, providing increased flexibility to enable optimal for different near and far field applications. The module operates over the North American UHF frequency band (902-928 MHz) and includes the RF, digital circuitry and embedded firmware required for ISO18000-6C (UHF Gen2) and ISO 18000-6B international standards. 3.3V CMOS level serial communications and 4 GPIO lines are available on a 15-pin connector. Mounting holes provide fast and easy mechanical integration. WJ's free demo software offers quick evaluation of the module without software development.



## Next Generation RFID Reader Module

Based on WJC200 Gen2 RFID reader chipset

### Absolute Maximum Rating\*

Parameter	Rating	Units
ESD Protection (per ISO 7816-1)	2	KV
Maximum Voltage	6	V
Operating Case Temperature	-20 to +55	°C
Storage Temperature	-40 to +65	°C

\*Operation of this device above any of these parameters may cause permanent damage.

### Specifications

Operating Conditions:  $V_{CC} = 5.0$  VDC,  $T_{AMB} = 25$  °C, 50  $\Omega$  System.

Symbol	Parameter	Min	Typ	Max	Units
$f_{RFID}$	RF Frequency—UHF Operation	902		928	MHz
$DRATE$	Data Rate		40		KHz
$f_{CH}$	Channel Spacing		500		kHz
$CH$	Frequency Hopping Channels		50		Channels
$V_{CC}$	Supply Voltage @ 1.3A, Connected to System	+4.85	+5.0	+5.50	V
$I_{PEAK\ OP}$	Peak Operating Current*			1.3	A
$P_{TX-Max}$	Maximum Transmit Power	18		30	dBm
$P_{RANGE}$	Power Control Range		12		dB
	Step Size		1		dB
$S_f$	Frequency Stability			10	ppm

\*Peak operating current for 1W CW output power; Average operating current draw is significantly less than CW peak current.



## Next Generation RFID Reader Module

Based on WJC200 Gen2 RFID reader chipset

### Protocol Support

Protocol	ID Read	ID Write	Data Read	Data Write	Password Write	Lock	Kill
ISO 18000-6B	X	X			X	X	
ISO-18000-6C (EPC Class1 Gen2)	X	X	X	X	X	X	X

### WJM3000 Mechanical Specifications

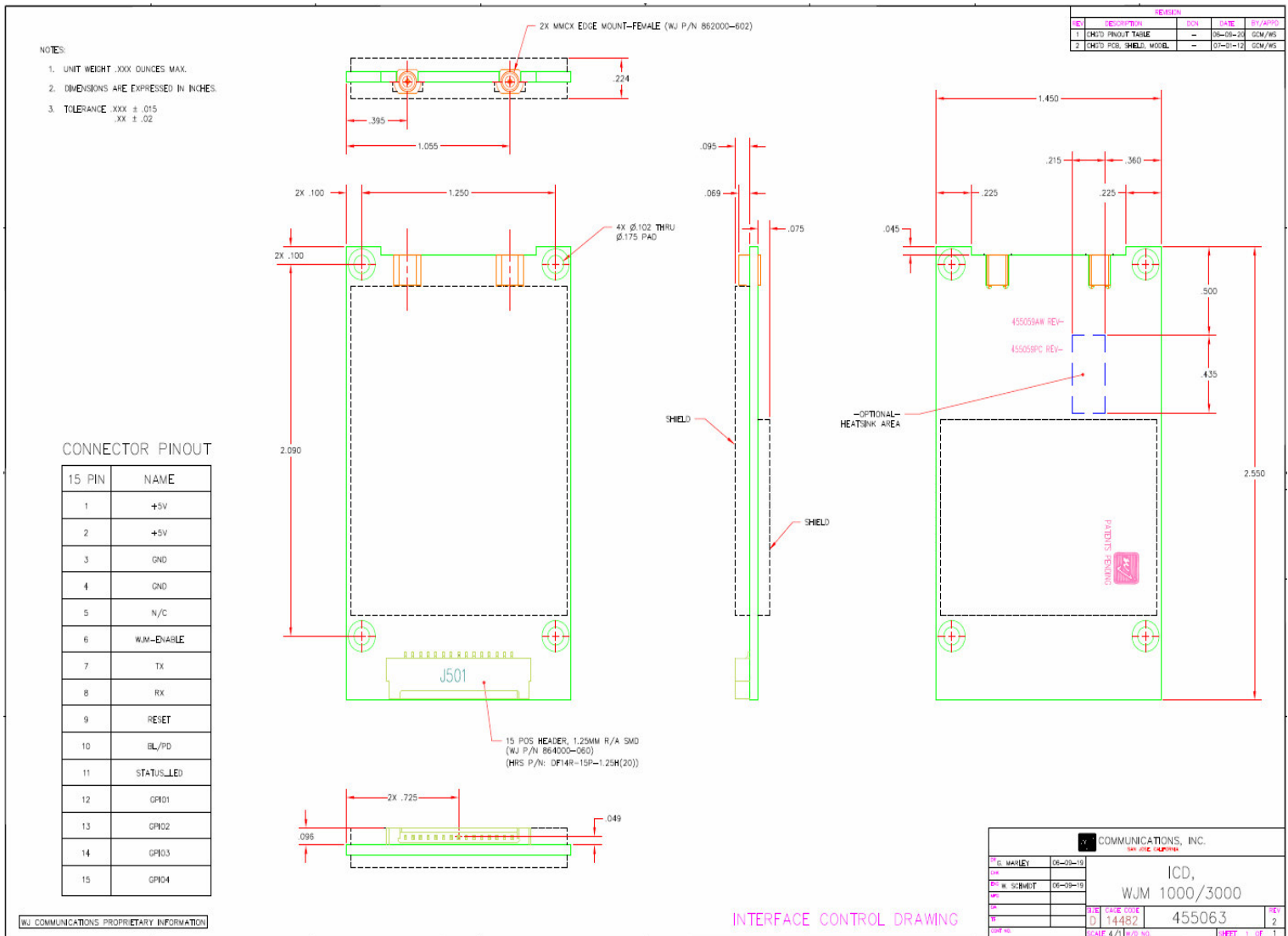



## Next Generation RFID Reader Module

Based on WJC200 Gen2 RFID reader chipset

Pin #	Name	Description
1, 2	+5.0 V	Power Supply. +5.0V @ 1.3 A
3,4	GND	Power Supply Ground Return
5	N/C	<i>No Connect</i>
6	WJM_EN	Active High Power Enable. Grounding this pin shuts off entire module. Minimum logic high voltage is +2.5V. 5V tolerant. Low impedance driver or a pull up resistor less than 2K required.
7	TX	3.3V CMOS logic-level UART transmit pin
8	RX	5V tolerant CMOS logic-level UART receive pin
9	nRESET	5V tolerant Active Low Reset Pin. 10K internal pull up, interface with open collector driver. When held low, WJM draws current but will not respond to commands. If nBL/nPD is held low as nRESET is brought high, the WJM enters Bootloader mode. If nBL/nPD is held high as nRESET is brought high, the WJM application starts. This pin can be left unconnected for minimal hardware configuration. A reset controller may be required if power supply rise time is slow.
10	nBL/nPD	5V tolerant Active Low Bootloader/PowerDown pin. 10K internal pull up, interface with open collector driver. This pin serves two functions. 1) If this pin is low at the rising edge of nRESET (including power-on), the Bootloader is activated for writing a new Firmware application (FW). If it is high, FW starts. 2) Once FW starts, bringing this pin low enables sleep mode. The module will not respond to API commands in sleep mode. Keep it high for normal operation. This pin can be left unconnected for minimal hardware configuration.
11	STATUS_LED	3.3V logic-level 3-state output: Logic high: OK Tri-State: Sleep Mode Logic low: Error
12	GPIO1	Currently FW configures these pins as outputs, they display various debug and status signals to LEDs. If unused they can be left un-connected.
13	GPIO2	
14	GPIO3	
15	GPIO4	



## Next Generation RFID Reader Module

Based on WJC200 Gen2 RFID reader chipset

### WJM3000 System Block Diagram

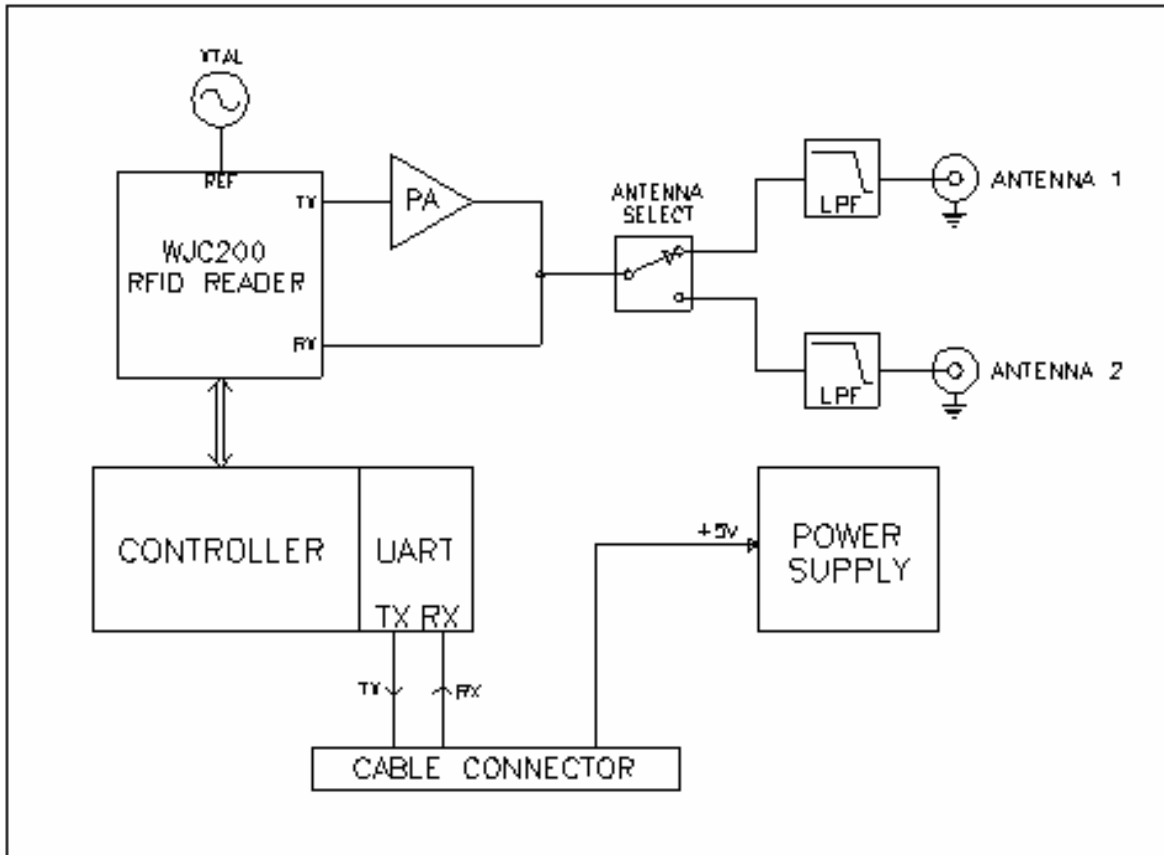



## Next Generation RFID Reader Module

Based on WJC200 Gen2 RFID reader chipset

### WJM3000 Performance Data

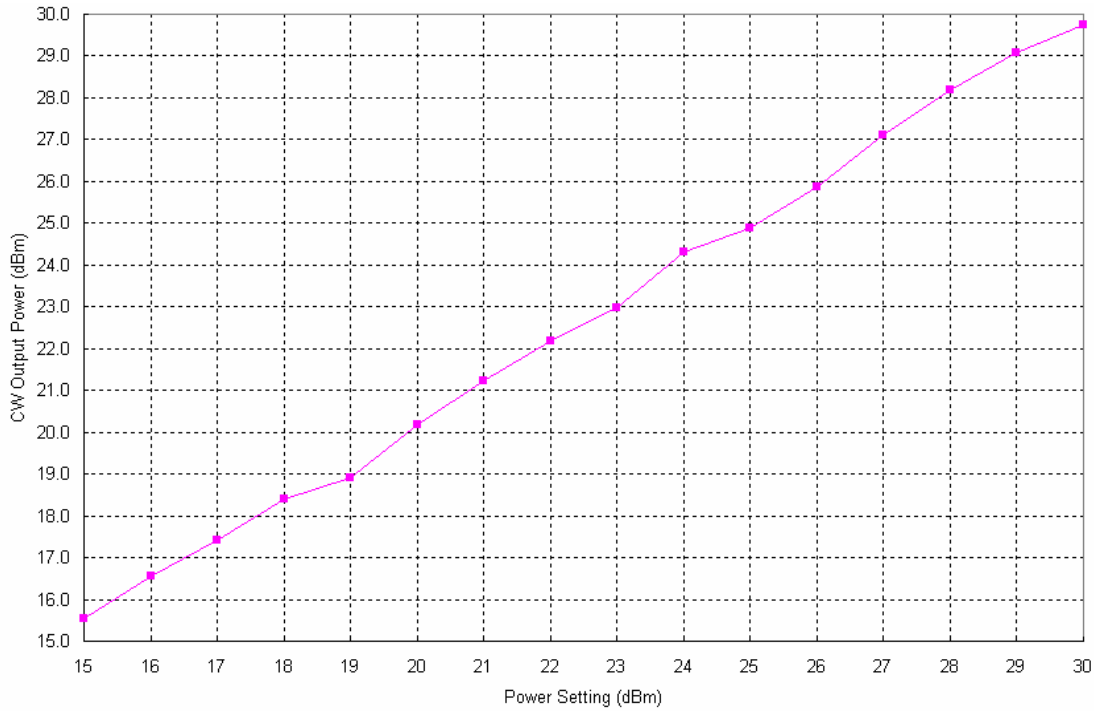

**Output Power**

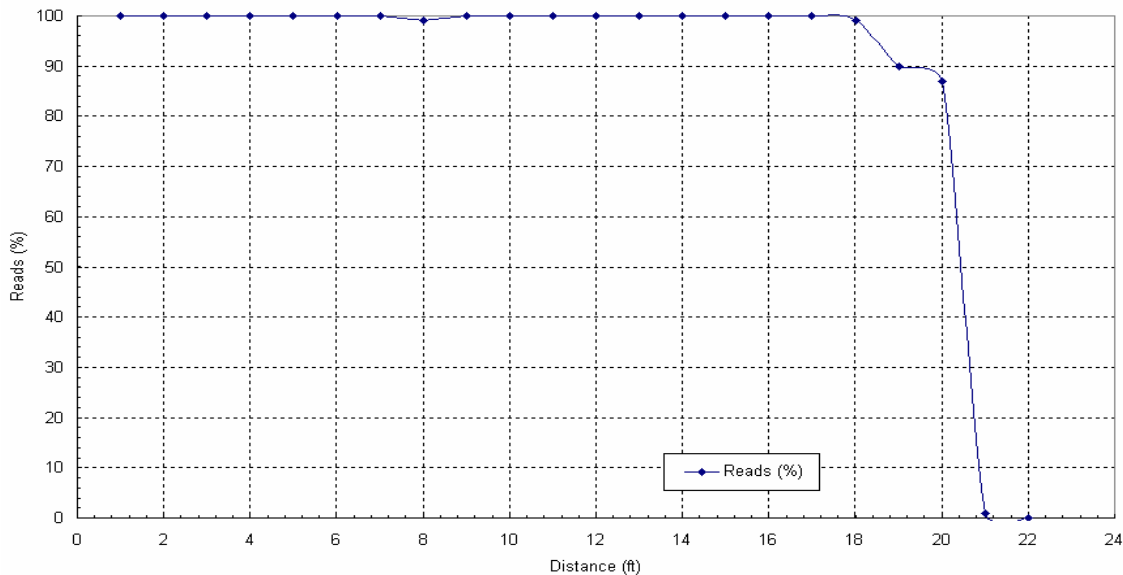

**Read Rate Vs Distance\***

\* +30 dBm with 6 dBi linear antenna. Read range/rate varies as a function of the environment, tag, and test conditions.



## Next Generation RFID Reader Module

Based on WJC200 Gen2 RFID reader chipset

### Interface Timing Diagrams

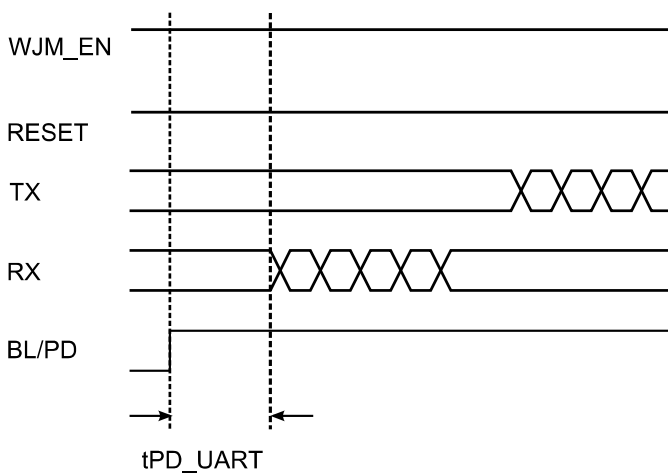
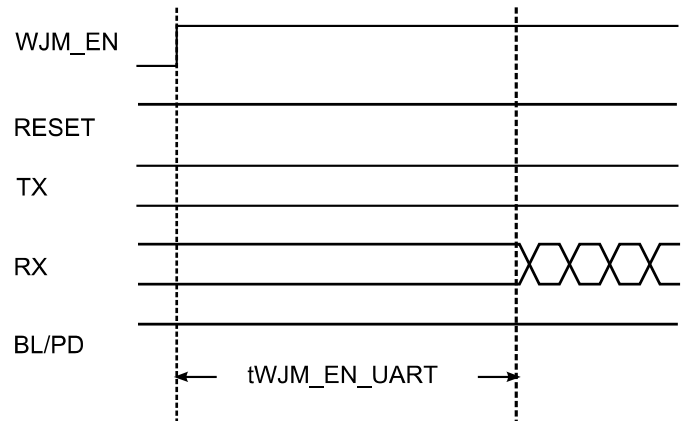
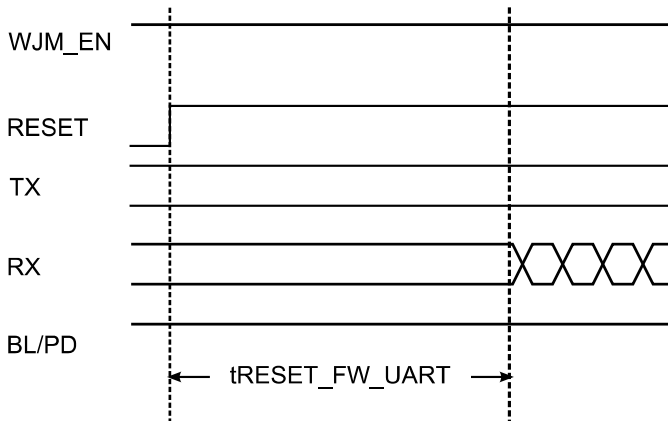
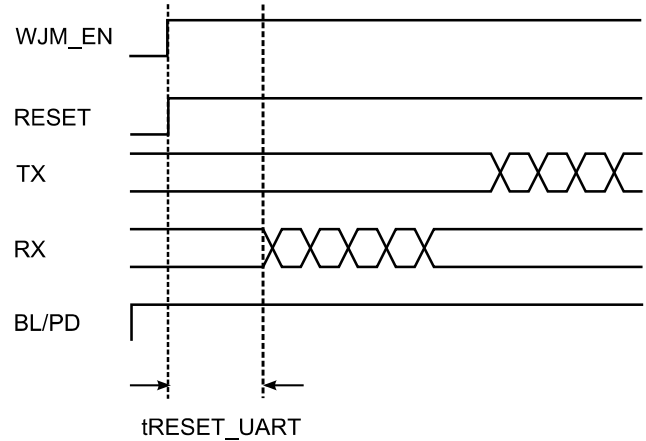
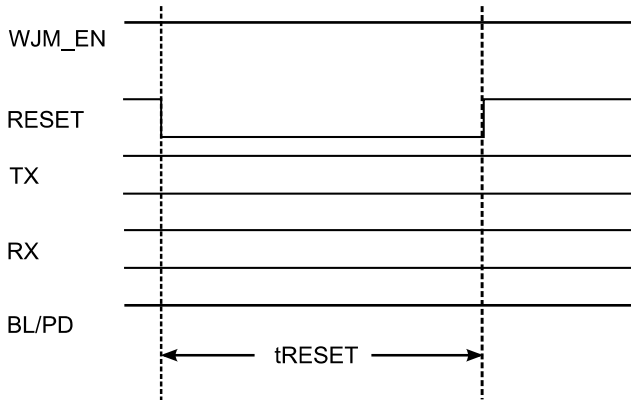

### Interface Timing

Signal Name	Description	Minimum Time (microseconds)
$t_{\text{RESET}}$	RESET pulse width	800
$t_{\text{RESET\_UART}}$	Delay between RESET and the start of TX/RX communications	400
$t_{\text{RE-SET\_FW\_UART}}$	Delay between RESET and the start of new firmware download	3000 (3 ms)
$t_{\text{WJM\_EN\_UART}}$	Delay between power-on via WJM_EN and the start of TX/RX communications	3000 (3 ms)
$t_{\text{PD\_UART}}$	Delay between return from power-save state (BL/PD) and the start of TX/RX communications	400