

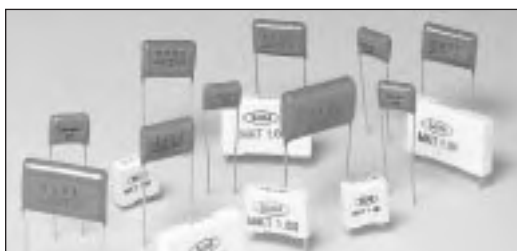









Sharma Film Capacitors



FILM CAPACITORS

Quick Reference Guide

Series (Former Series)	Dielectric/ Construction	Lead Spacing millimeters / (inches)	Capacitance Range Voltage Range	Style
MKT 050 (MKT1.85)	Metallized Polyester <i>Molded can</i>	5.0 (0.200")	0.001 μ F to 1.0 μ F 50 VDC to 400 VDC	
MKT 075 (MKT1.67)	Metallized Polyester <i>Molded can</i>	7.5 (0.300")	0.033 μ F to 0.33 μ F 100 VDC to 630 VDC	
MKT 100 (MKT1.60)	Metallized Polyester <i>Molded can</i>	10.0 (0.400"), 15.0 (0.600"), 22.5 (0.886"), 27.5 (1.083")	0.001 μ F to 6.8 μ F 100 VDC to 1000 VDC	
MKT 00S (SMX)	Metallized Polyester <i>Epoxy molded</i>	Surface Mount	0.01 μ F to 0.22 μ F 50 VDC to 630 VDC	
MKT D01 (MPD-1)	Metallized Polyester <i>Epoxy dipped</i>	10.0 (0.400"), 15.0 (0.600"), 22.5 (0.886"), 27.5 (1.083")	0.001 μ F to 6.8 μ F 100 VDC to 630VDC	
MKT D02 (MPD-2)	Metallized Polyester <i>Epoxy dipped</i>	10.0 (0.400"), 15.0 (0.600"), 17.5 (0.689"), 25.0 (0.984") 27.5 (1.083")	0.01 μ F to 3.9 μ F 100 VDC to 630VDC	
MKT D03 (MPD-3)	Metallized Polyester <i>Epoxy dipped</i>	10.0 (0.400"), 15.0 (0.600"), 17.5 (0.689"), 25.0 (0.984") 27.5 (1.083")	0.01 μ F to 3.9 μ F 100 VDC to 630VDC	
MKTR (MPR)	Metallized Polyester <i>Tape wrapped</i>	Rounded Axial	0.01 μ F to 6.8 μ F 63 VDC to 630 VDC	
MKTO (MPO)	Metallized Polyester <i>Tape wrapped</i>	Oval Axial	0.01 μ F to 6.8 μ F 63 VDC to 630 VDC	

PLASTIC FILMS USED IN CAPACITORS

The capacitance value of a capacitor depends on the area of the dielectric separating the two conductors, its thickness and the dielectric constant. Other properties of the film such as the temperature coefficient, the dissipation factor, the voltage handling capabilities, its suitability to be metallized etc. also influence the choice of the dielectric.

POLYESTER FILM

This film has a relatively high dielectric constant which makes it suitable for designs of a capacitor with high volumetric efficiency. It also has high temperature stability, high voltage and pulse handling capabilities and can be produced in very low thickness. It can also be metallized. Polyester is a popular dielectric for plain film capacitors as well as metallized film capacitors.

POLYPROPYLENE FILM

The dielectric constant of polypropylene is slightly higher than that of polyester which makes the capacitors relatively bigger in size. This film has a low dissipation factor and excellent voltage and pulse handling capabilities together with a low and negative temperature coefficient which is an ideal characteristic for many designs. Polypropylene has the capability to be metallized.

POLYSTYRENE FILM

The dielectric constant of Polystyrene is relatively lower resulting in larger physical size of capacitors. Though the temperature handling capability of this film is lower than that of the other films, it is extremely stable within the range. Its low dissipation factor and the negative, near linear temperature coefficient characteristics make it the ideal dielectric for precision capacitors. Polystyrene cannot be metallized.

Cross Reference Guide

SHARMA (former series)	MKT 050 MKT1.85	MKT 075 MKT1.67	MKT 100 MKT1.60	MKT 00S SMX	MKT D01 MPD-1	MKT D02 MPD-2	MKT D03 MPD-3	MKTR MPR	MKTO MPO
Arcotronics	R.85	R.66	R.60	LDA	-	-	-	-	-
Evox	MMK 5	MMK	MMK	-	-	-	-	-	-
MEPCO*	712A 1	719A 1	719A 1	-	712A 1	712A 1	712A 1	-	-
Philips	370	371	372 & 373	-	367 to 369	366 to 369	367 to 369	-	-
Roederstein	MKT1817	MKT1818	MKT1822	MKT1824	-	-	-	MKT1813	-
Siemens	B32529	B32520/30	B32521/31	-	5140 to 44	5140 to 44	5140 to 44	-	-
Thompson	IRD/MC	IRD/MC	IRD/MC	-	MD	MD	MD	-	-
Wima	MKS 2	MKS 3	MKS 4	SMD 7.3	-	-	-	-	-

* MEPCO SERIES ARE BEING REPLACED WITH PHILIPS SERIES AS LISTED IN THE TABLE. BOTH SERIES ARE LISTED FOR YOUR CONVENIENCE.

Sharma Film Capacitors

Ordering/Part Numbering

Example below indicates: MKT100 Series, 0.1 μ F, 5% Tol., 100 Volts, Bulk.

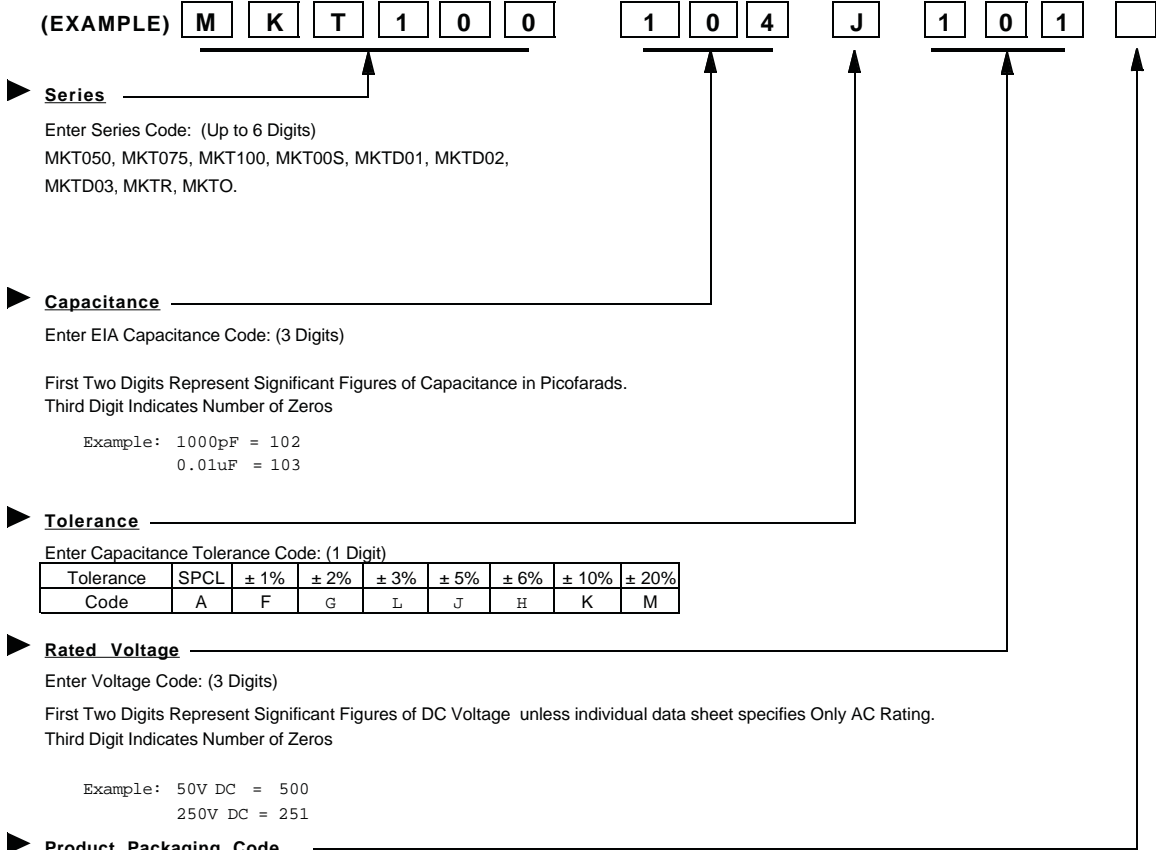

Packaging Code	Packaging Style
T	Tape / Reel
A	Ammo
(no code)	Bulk

Part Marking

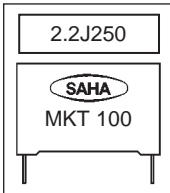

BOX TYPE

The Capacitance value is marked in μ F together with the Tolerance code and the DC Voltage Figures on the top surface of the capacitors. The capacitance is also marked in Nano Farads with "n" representing the decimal point in the capacitance value. The SAHA logo and series codes, MKT100, MKP 100, KP300 etc., or their former series designations, are marked on the side. MKT100 series is supplied in certain cases, without series code marking. SAHA logo may be replaced with marking, "SH" or "S" depending upon the limitations of space.

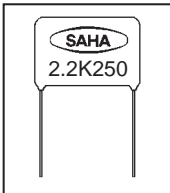

DIPPED TYPE

The Capacitance value is marked in μ F along with the Tolerance code and the DC Voltage Figures on the side of the capacitors. The capacitance is also marked in Capacitance code with the first two digits representing the significant digits followed by one digit representing the number of zeros. The SAHA logo may be replaced with marking, "SH", "S" or no brand marking depending on the limitation of space.

OTHER TYPES

All other types of capacitors such as tape wrapped axial, tape wrapped radial, vertical box type etc., are also marked on the body of the capacitor with the similar information in one of the combinations, as explained above. In addition, in certain cases, the outer foil side is also indicated with a dot or ring.

Sharma Film Capacitors

PERFORMANCE CHARACTERISTICS

ELECTRICAL - BASIC PARAMETERS

1.1 RATED CAPACITANCE

The nominal or rated value of capacitance is measured at 25 °C in an measuring bridge with 1K Hz source, free of harmonics. Please refer to relevant series for the range of capacitance value covered. Capacitance is frequency and temperature dependent. The variation pattern of capacitance with temperature and frequency is explained in sections 2.1 and 2.2.

1.2 CAPACITANCE TOLERANCE

The permitted variation of actual value from the nominal value is termed the tolerance. The tolerance is expressed in percentage. The standard tolerances for plastic film capacitors are $\pm 5\%$ (J), $\pm 10\%$ (K) and $\pm 20\%$ (M).

1.3 RATED VOLTAGE

The voltage at which the capacitor can operate continuously up to a temperature of 85 °C (unless otherwise specified) is the rated voltage. As this is a critical parameter for choosing a capacitor, the case sizes are listed in a matrix of capacitance value and rated voltage.

1.4 CATEGORY VOLTAGE

The maximum voltage that may be applied continuously over the temperature range is termed the category voltage. This is same as the rated voltage up to 85 °C unless otherwise specified in the climactic category of the product. Above 85 °C a derating has to be applied depending upon the dielectric.

1.5 OPERATING TEMPERATURE

This is the temperature range with in which the capacitor can function as specified in the climactic category. Please refer to relevant sections for derating above the temperature at which the full rated voltage can be applied.

1.6 DISSIPATION FACTOR

This is the measurement of tangent of loss angle ($\tan d$) and is expressed as a percentage. Measurement of dissipation factor is carried out at 1 K Hz. or 10 K Hz. as specified in the data sheet of the relevant series at 25 °C. Dissipation factor is temperature and frequency dependent. The nature of variation of dissipation factor with temperature and frequency for different dielectric are explained in Figures 2.3A to 2.3C and 2.4A to 2.4C.

1.7 INSULATION RESISTANCE

Insulation Resistance is the electrical resistance offered by the capacitor. The Insulation Resistance is measured directly in Mega Ohms where as for higher capacitance values it is expressed in seconds as the product of M Ohm and μF .

1.8 PULSE RISE TIME

The pulse rise time or dv/dt rating is the capability of the capacitor to handle rapid changes in voltage or pulse. This is expressed in terms of Volts per μ seconds. The dv/dt rating of a capacitor depends upon the dielectric as well as the design and construction of the capacitors. The dv/dt values of different types of capacitors are listed in the corresponding data sheets of the capacitors.

ELECTRICAL - EFFECTS AND RELATIONS

2.1 TEMPERATURE DEPENDENCE OF CAPACITANCE

Capacitance of plastic film capacitors vary with temperature. However the pattern of variation is different for different plastic film dielectrics such as Polystyrene, Polyester and Polypropylene. The variation patterns for these dielectrics are shown in figure 2.1A, 2.1B and 2.1C. The rate of change of capacitance with temperature is termed the Temperature Coefficient. The nominal values of temperature coefficient for different dielectrics are shown below.

DIELECTRICS	POLYSTYRENE	POLYESTER	POLYPROPYLENE
TEMPERATURE COEFFICIENT	-150 ppm	+400 ppm	-200 ppm

2.2 FREQUENCY DEPENDENCE OF CAPACITANCE

Capacitance reduces with increase in frequency. The variation pattern for different dielectrics are shown in figure 2.2A, 2.2B and 2.2C.

2.3 TEMPERATURE DEPENDENCE OF DISSIPATION FACTOR

The dissipation factor varies with temperature. Each dielectric follows a unique variation pattern. The variation pattern for different dielectrics are shown in figure 2.3A, 2.3B and 2.3C.

Figure 2.1A

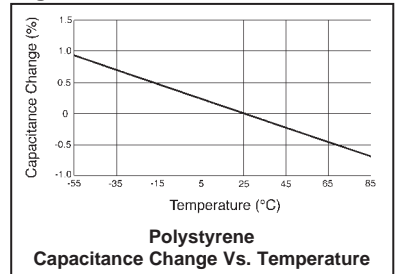

Figure 2.1B

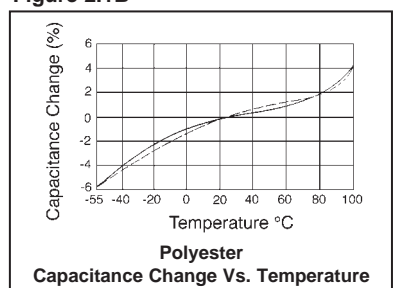

Figure 2.1C

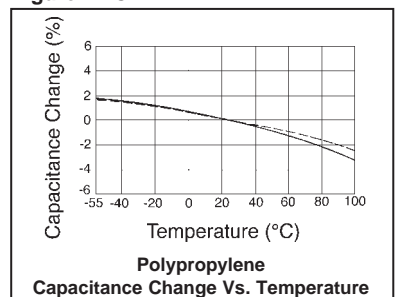

Figure 2.2A

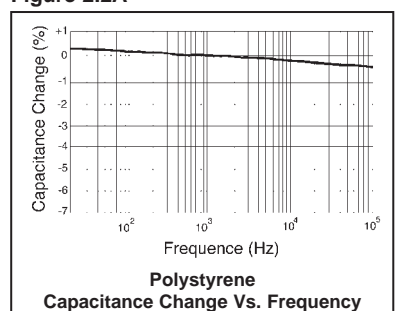

Figure 2.2B

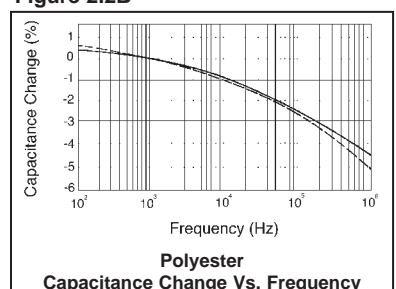
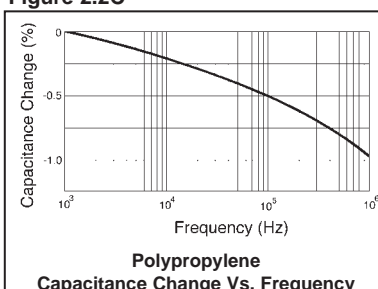

Figure 2.2C



Sharma Film Capacitors

Figure 2.3A

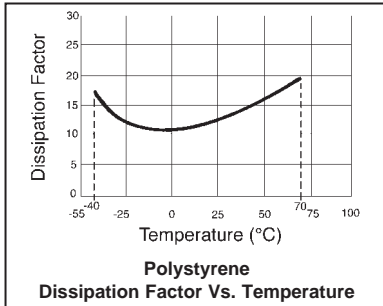
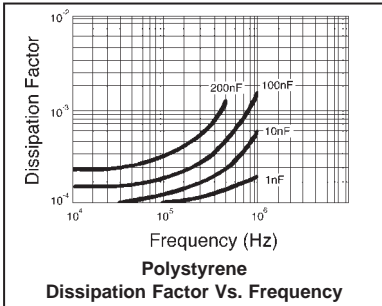

Figure 2.4A



2.4 FREQUENCY DEPENDENCE OF DISSIPATION FACTOR

Dissipation factor increased with frequency. The variation pattern is different for different dielectrics. The typical variation pattern for different dielectrics are shown in fig. 2.4A, 2.4B and 2.4C.

2.5 TEMPERATURE DEPENDENCE OF INSULATION RESISTANCE

The insulation resistance of the dielectric varies with temperature. The variation pattern is different fro different dielectric films. The typical variation pattern for different dielectrics are shown in figure 2.5A, 2.5B and 2.5C.

Figure 2.3B

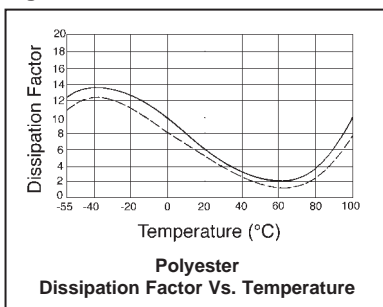
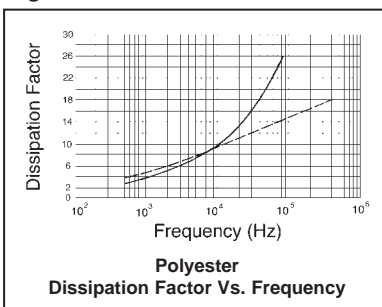

Figure 2.4B



ELECTRICAL - AC APPLICATIONS

When a capacitor is connected to alternating voltage its electrodes are alternately charged positive and negative. The charge alternates with a rhythm of double the frequency of the alternating voltage. Thus there is alternating current flowing in the leads of the capacitor.

3.1 ACROSS THE LINE APPLICATIONS

In this application the capacitor is connected between the lines, ie, between the main phase and neutral line terminals. In this type of application, failure of capacitor due to short circuit will not result in an electric shock. The capacitors rated for normal across the line applications are termed class-X2 capacitors.

3.2 BETWEEN LINE AND GROUND APPLICATIONS

In this type of application the capacitors are connected between the line and the ground, ie, between the phase terminal and the body. In this application, failure of the capacitor due to short circuit could possibly expose somebody touching the appliance to an electric shock. The capacitors rated for this application are termed class-Y capacitors.

Figure 2.3C

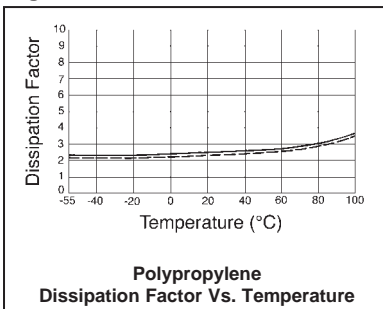
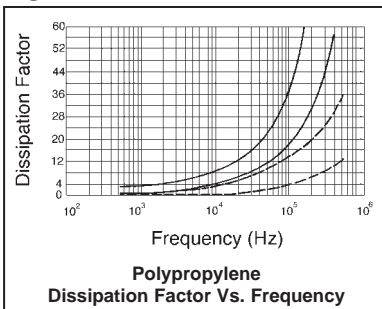

Figure 2.4C



MECHANICAL CHARACTERISTICS

4.1 RESISTANCE TO SOLVENTS

The encapsulation technics adopted in the manufacture of plastic film capacitors ensure resistance to a wide range of solvents and cleaning liquids. The epoxy end sealed boxed capacitors can stand Trichloro trifluorethane, Methanol, Ethanol, Isopropanol and Aqueous cleaning solvents.

4.2 SOLDERABILITY

A minimum of 3/4 of the circumferential surface of the terminations will be covered with new solder when dipped in molten solder bath at 230 °C for 2 ±1 sec. after immersing in methanol - rosin solution at room temperature for 5 to 10 seconds.

Figure 2.5A

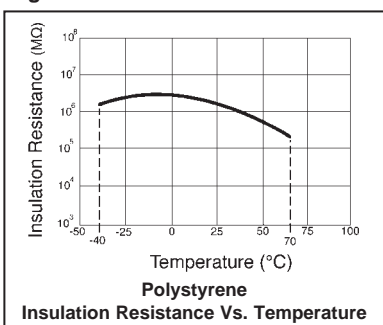

Figure 2.5B

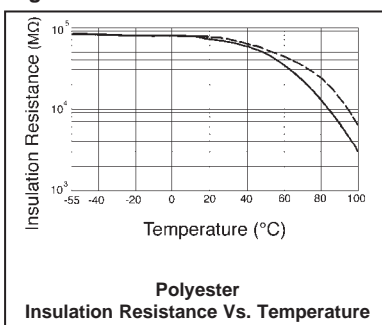
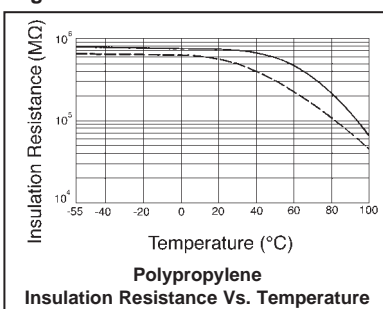

Figure 2.5C



4.3 TERMINAL STRENGTH

The leads are made of tinned copper wire. The terminals are capable of withstanding an axial load of 2.25 Kgs(5 lbs).

ENVIRONMENTAL

RESISTANCE TO HUMIDITY

The capacitor samples will be exposed to 93 ±2 °C for 56 days at 40 ±2 °C. After the test the capacitance change shall be within 3% of the original value, The insulation resistance shall be within 50% of the initial limits and the dissipation factor shall remain within the initial specifications.

Sharma Film Capacitors

MKT 050 SERIES

Formerly MKT 1.85 series

INTRODUCTION

The MKT 050 Series Metallized Polyester Film Capacitors are miniature capacitors with 5 mm lead spacing. This series covers a wide range of values and voltages and exhibit excellent high frequency characteristics. In addition to specific applications such as Blocking, Bypassing and Coupling, this series is widely used in all General Purpose applications.

FEATURES

- Wide value and Voltage range
- Ultra miniature size
- Flame retardant case and potting
- Consistent dimensions and surface finish due to molded case construction
- Available in tape & reel form for automatic insertion
- Self healing capability

GENERAL SPECIFICATIONS:

Dissipation factor: For capacitance $\leq 0.1 \mu\text{F} = 0.010$ max at 1 KHz, 0.015 max at 10 KHz, 0.030 max at 100 KHz. For capacitance $> 0.1 \mu\text{F} = 0.0010$ max at 1 KHz, 0.0015 max at 10 KHz. **Insulation resistance:** For nominal voltage $< 100 \text{ V DC}$; $\geq 10,000 \text{ M Ohms}$ for $C \leq 0.10 \mu\text{F}$, $\geq 1,000$ seconds for $C > 0.10 \mu\text{F}$. For nominal voltage $\leq 100 \text{ V DC}$; $\geq 30,000 \text{ M Ohms}$ for $C \leq 0.10 \mu\text{F}$, $\geq 1,000$ seconds for $C > 0.10 \mu\text{F}$ at a temperature of $25 \pm 5^\circ\text{C}$. **Capacitance tolerance:** $\pm 5\%$ (J), $\pm 10\%$ (K) and $\pm 20\%$ (M) **Voltage Test:** 1.6 times the rated voltage applied between terminals for 2 seconds at a temperature of $25 \pm 5^\circ\text{C}$ **Temperature range:** -55 to 100°C with derating above 85°C **Climatic category:** F M D

LIFE TEST DETAILS:

Capacitors shall withstand 125% DC rated voltage or 100% AC rated voltage applied at 85°C for 1000 hours. After the test:

1. Capacitance change shall remain within $\pm 5\%$.
2. Dissipation Factor shall be within 1.5 times the original limits.
3. Insulation Resistance shall be above 50% of the initial limits.
4. There shall be no remarkable change in the appearance and the marking shall remain legible.

DIMENSIONS AND TOLERANCES:

"d" = 0.5 to 0.6 mm (0.020 to 0.024") for dimension "T" ≤ 3.5 mm (0.138")

"d" = 0.6 mm (0.024") for dimension "T" > 3.5 mm (0.138")

"LL" = 4.0 ± 1.5 mm (0.16 ± 0.06 ") for Bulk Supply

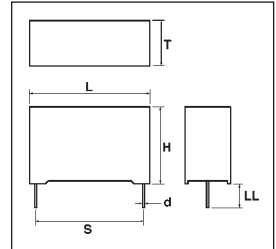

PULSE RISE TIME (dv/dt) Volts per μsec .

RATED VOLTAGE	Capacitance Range μF	dv/dt value
50	0.001-1.0	4
63	0.001-1.0	8
100	> 0.0068	10
100	0.0033-0.0068	15
100	> 0.0033	30
250	0.001-1.0	20
400	0.001-1.0	40

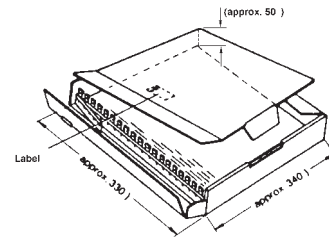
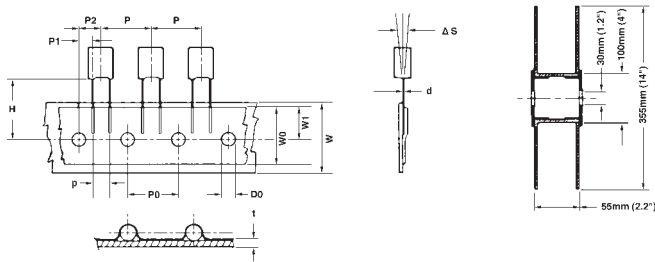

Taping Dimensions for MKT 050 Series (5mm Pitch)

DESCRIPTION	DIMENSION		TOLERANCES	
	mm	Inches	mm	Inches
d Leadwire dia.	0.5 to 0.6	0.020 to 0.024	± 0.05	± 0.002
P Taping pitch	12.7	0.500	± 1	± 0.039
P0 Sprocket hole pitch	12.7	0.500	± 0.2	± 0.008
P1 Centering of leadwire	3.85	0.152	± 0.7	± 0.028
P2 Centering of the body	6.35	0.250	± 1.3	± 0.051
p Lead spacing	5	0.197	$+0.6 / -1.1$	$+0.024 / -0.043$
dS Component alignment	0	0.000	± 2	± 0.079
H Height from Sprocket Center to component body	16.0, 16.5 or 18.5	0.630, 0.650 or 0.728	± 0.5	± 0.020
w Tape width	18	0.709	$+1.0 / -0.5$	$+0.039 / -0.020$
W0 Width of adhesive tape	6 min.	0.236 min.		
W1 Sprocket hole alignment	9	0.354	± 0.5	± 0.020
D0 Position hole diameter	4	0.157	± 0.2	± 0.008
t Tap thickness	0.7	0.028	± 0.2	± 0.008

Packaging Specifications

Bulk, Tape/Reel & Ammo Pack

BOX SIZE T x H x L	BULK CARTON	TAPED	
		REEL PACK	AMMO PACK
2.5 x 6.5 x 7.2	3000	2500	3500
3.0 x 6.5 x 7.2	3000	2100	2900
3.5 x 7.5 x 7.2	2000	1800	2500
4.5 x 9.5 x 7.2	1500	1400	1900
5.0 x 10.0 x 7.2	1000	1200	NA
6.0 x 11.0 x 7.2	2000	1000	NA
7.2 x 13.0 x 7.2	1500	800	NA

Sharma Film Capacitors

MKT 100 SERIES CASE DIMENSIONS CONTINUED

Case Dimensions in Inches 100V • 160V• 250V• 400V• 630V• 1000V

Voltage Cap Value in μ F	100 V DC / 63 V AC				160 V DC / 90 V AC				250 V DC / 160 V AC				400 V DC / 200 V AC				630 V DC / 220 V AC				1000 V DC / 250 V AC												
	Dimensions in Inches				Dimensions in Inches				Dimensions in Inches				Dimensions in Inches				Dimensions in Inches				Dimensions in Inches												
	L	H	T	S	L	H	T	S	L	H	T	S	L	H	T	S	L	H	T	S	L	H	T	S									
0.001																								0.512	0.354	0.157	0.394						
0.0015																											0.512	0.354	0.157	0.394			
0.0022																													0.512	0.354	0.157	0.394	
0.0033																														0.512	0.354	0.157	0.394
0.0047																														0.512	0.354	0.157	0.394
0.0068																														0.512	0.354	0.157	0.394
0.001																														0.512	0.354	0.157	0.394
0.015																														0.512	0.354	0.157	0.394
0.022																														0.512	0.354	0.157	0.394
0.033																														0.512	0.354	0.157	0.394
0.047																														0.512	0.354	0.157	0.394
0.068																														0.512	0.354	0.157	0.394
0.1																														0.512	0.354	0.157	0.394
0.15	0.512	0.354	0.157	0.394	0.512	0.433	0.197	0.394	0.709	0.433	0.197	0.591	0.709	0.433	0.197	0.591	0.709	0.433	0.197	0.591	0.709	0.433	0.197	0.591	1.043	0.591	0.236	0.886					
0.22	0.512	0.433	0.197	0.394	0.512	0.433	0.197	0.394	0.709	0.433	0.197	0.591	0.709	0.433	0.197	0.591	1.043	0.591	0.236	0.886	1.043	0.630	0.276	0.886	1.260	0.787	0.433	1.083					
0.33	0.709	0.433	0.197	0.591	0.709	0.433	0.197	0.591	0.709	0.472	0.236	0.591	1.043	0.630	0.276	0.886	1.260	0.787	0.433	1.083													
0.47	0.709	0.433	0.197	0.591	0.709	0.472	0.236	0.591	1.043	0.591	0.236	0.886	1.043	0.669	0.335	0.886	1.260	0.866	0.512	1.083													
0.68	0.709	0.472	0.236	0.591	0.709	0.531	0.295	0.591	1.043	0.630	0.276	0.886	1.260	0.669	0.354	1.083																	
1.0	0.709	0.531	0.295	0.591	0.709	0.571	0.335	0.591	1.043	0.669	0.335	0.886	1.260	0.787	0.433	1.083																	
1.5	1.043	0.630	0.276	0.886	1.043	0.669	0.335	0.886	1.260	0.669	0.354	1.083																					
2.2	1.043	0.669	0.335	0.886	1.043	0.728	0.394	0.886	1.260	0.787	0.433	1.083																					
3.3	1.043	0.728	0.394	0.886	1.260	0.787	0.433	1.083	1.260	0.866	0.512	1.083																					
4.7	1.260	0.787	0.433	1.083	1.260	0.866	0.512	1.083																									
6.8	1.260	0.866	0.512	1.083																													

MKT 075 SERIES

Formerly MKT 1.67 series

INTRODUCTION:

The MKT 075 Series Metallized Polyester Film Capacitors are specially designed for use in thickly populated Printed Circuit Boards where miniaturization is important. These capacitors are widely used in all General Purpose applications.

FEATURES:

- Wide value and Voltage range
- Flame retardant case and potting
- Consistent dimensions and surface finish due to molded case construction
- Self healing capability

GENERAL SPECIFICATIONS:

Dissipation factor: ≤ 0.015 at 10 K Hz for capacitance $< 1.0 \mu$ F

Insulation resistance: For nominal voltage ≤ 100 V DC, $\geq 10,000$ M Ohm for $C \leq 0.1 \mu$ F, $\geq 1,000$ seconds for $C > 0.1 \mu$ F, For nominal voltage > 100 V DC, $\geq 30,000$ M Ohm for $C \leq 0.33 \mu$ F, $\geq 10,000$ seconds for $C > 0.33 \mu$ F. **Capacitance tolerance:** $\pm 5\%$ (J), $\pm 10\%$ (K) and $\pm 10\%$ (M)

Voltage Test : 1.6 times the rated voltage applied between terminals for 2 seconds. at temperature of 25 ± 5 °C

Temperature range: -55 to 100 °C with derating above 85 °C

Climatic category: F M D

LIFE TEST DETAILS:

Capacitors shall withstand 125% DC rated voltage or 100% AC rated voltage applied at 85 °C for 1000 hours. After the test:

1. Capacitance change shall remain within $\pm 5\%$.
2. Dissipation Factor shall be within 1.5 times the original limits.
3. Insulation Resistance shall be above 50% of the initial limits.
4. There shall be no remarkable change in the appearance and the marking shall remain legible.

DIMENSIONS AND TOLERANCES:

"d" - 0.6 mm (0.024")

for dimension "T" = 4mm (0.160")

"d" - 0.8 mm (0.032")

for dimension "T" > 4mm (0.160")

"LL" - 6.0 ± 1.0 mm

(0.24 ± 0.04 ")

Tolerance on "s" ± 0.4 mm (0.016")

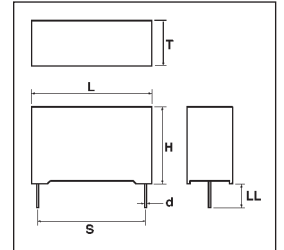

PULSE RISE TIME (dv/dt) Volts per μ sec.

RATED VOLTAGE	dv/dt - Volts- per μ Seconds
100	6
250	15
400	30
630	40

Sharma Film Capacitors

MKT 075 SERIES CASE DIMENSIONS

Case Dimensions in Millimeters 100V • 250V

Capacitance in μF	VOLTAGE DC/AC							
	100 V DC / 63 V AC				250 V DC / 160 V AC			
	Dimensions in Millimeters				Dimensions in Millimeters			
	L	H	T	S	L	H	T	S
0.01					10.5	9.0	4.0	7.5
0.015					10.5	9.0	4.0	7.5
0.022					10.5	9.0	4.0	7.5
0.033	10.5	9.0	4.0	7.5	10.5	9.0	4.0	7.5
0.047	10.5	9.0	4.0	7.5	10.5	9.0	4.0	7.5
0.068	10.5	9.0	4.0	7.5	10.5	11.0	5.0	7.5
0.1	10.5	9.0	4.0	7.5	10.5	11.0	5.0	7.5
0.15	10.5	9.0	4.0	7.5	10.5	12.0	6.0	7.5
0.22	10.5	11.0	5.0	7.5				
0.33	10.5	12.0	6.0	7.5				

Capacitance in μF	VOLTAGE DC/AC							
	400 V DC / 200 V AC				630 V DC / 250 V AC			
	Dimensions in Millimeters				Dimensions in Millimeters			
	L	H	T	S	L	H	T	S
0.001					10.5	9.0	4.0	7.5
0.0015					10.5	9.0	4.0	7.5
0.0022					10.5	9.0	4.0	7.5
0.0033					10.5	9.0	4.0	7.5
0.0047	10.5	9.0	4.0	7.5	10.5	9.0	4.0	7.5
0.0068	10.5	9.0	4.0	7.5	10.5	9.0	4.0	7.5
0.01	10.5	9.0	4.0	7.5	10.5	11.0	5.0	7.5
0.015	10.5	9.0	4.0	7.5	10.5	12.0	6.0	7.5
0.022	10.5	11.0	5.0	7.5				
0.033	10.5	12.0	6.0	7.5				

Case Dimensions in Inches 100V • 250V

Capacitance in μF	VOLTAGE DC/AC							
	100 V DC / 63 V AC				250 V DC / 160 V AC			
	Dimensions in Inches				Dimensions in Inches			
	L	H	T	S	L	H	T	S
0.01					0.413	0.354	0.157	0.295
0.015					0.413	0.354	0.157	0.295
0.022					0.413	0.354	0.157	0.295
0.033	0.413	0.354	0.157	0.295	0.413	0.354	0.157	0.295
0.047	0.413	0.354	0.157	0.295	0.413	0.354	0.157	0.295
0.068	0.413	0.354	0.157	0.295	0.413	0.433	0.197	0.295
0.1	0.413	0.354	0.157	0.295	0.413	0.433	0.197	0.295
0.15	0.413	0.354	0.157	0.295	0.413	0.472	0.236	0.295
0.22	0.413	0.433	0.197	0.295				
0.33	0.413	0.472	0.236	0.295				

Capacitance in μF	VOLTAGE DC/AC							
	400 V DC / 200 V AC				630 V DC / 250 V AC			
	Dimensions in Inches				Dimensions in Inches			
	L	H	T	S	L	H	T	S
0.001					0.413	0.354	0.157	0.295
0.0015					0.413	0.354	0.157	0.295
0.0022					0.413	0.354	0.157	0.295
0.0033					0.413	0.354	0.157	0.295
0.0047	0.413	0.354	0.157	0.295	0.413	0.354	0.157	0.295
0.0068	0.413	0.354	0.157	0.295	0.413	0.354	0.157	0.295
0.01	0.413	0.354	0.157	0.295	0.413	0.433	0.197	0.295
0.015	0.413	0.354	0.157	0.295	0.413	0.472	0.236	0.295
0.022	0.413	0.433	0.197	0.295				
0.033	0.413	0.472	0.236	0.295				

MKTD01 SERIES

Formerly MPD 1 series

INTRODUCTION:

The MKTD01 Series Metallized Polyester Film Capacitors cover a wide range of values and voltages. They are suitable for applications such as Blocking, By-passing and Coupling and are widely used in General communication equipment.

FEATURES:

- Wide value and Voltage range
- Self healing capability
- Flame retardant powder epoxy encapsulation
- Minimum overall dimensions due to dip coated construction

GENERAL SPECIFICATIONS:

Dissipation factor: < 0.0100 at 1 K Hz for capacitance $\leq 1.0\mu\text{F}$, < 0.0150 at 1 K Hz for capacitance > $1.0\mu\text{F}$ **Insulation resistance:** For 100 VDC rated parts; $\geq 9,000 \text{ M Ohms for } C \leq 0.33\mu\text{F}$, $\geq 3,000 \text{ seconds for } C > 0.33\mu\text{F}$, at a temperature of $25 \pm 5^\circ\text{C}$, For 250 to 630 VDC rated parts $\geq 15,000 \text{ M Ohms for } C \leq 0.33\mu\text{F}$, $\geq 5,000 \text{ seconds for } C > 0.33\mu\text{F}$, at a temperature of $25 \pm 5^\circ\text{C}$.

Capacitance tolerance: $\pm 5\%$ (J), $\pm 10\%$ (K) and $\pm 20\%$ (M) (Special parts with close tolerance of $\pm 1\%$ and $\pm 2\%$ available on request) **Voltage Test :** 1.6 times the rated voltage applied between terminals for 2 seconds. at a temperature of $25 \pm 5^\circ\text{C}$

Temperature range: -55 to 85°C **Climatic category:** F M F

LIFE TEST DETAILS:

Capacitors shall withstand 125% DC rated voltage or 100% AC rated voltage applied at 85°C for 1000 hours. After the test:

1. Capacitance change shall remain within $\pm 5\%$.
2. Dissipation Factor shall be within 1.5 times the original limits.
3. Insulation Resistance shall be above 50% of the initial limits.
4. There shall be no remarkable change in the appearance and the marking shall remain legible.

DIMENSIONS AND TOLERANCES:

d - 0.6 mm (0.024") for
Lead Spacing "s" = 10.0 mm (0.40")
d - 0.8 mm (0.032") for
Lead Spacing "s" > 10.0 mm (0.40")
z - 1.5mm (0.06") max.

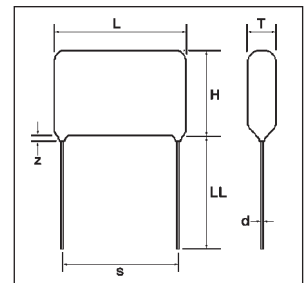

LL" - 20.0 mm min.(0.78")
Tolerance on "s" $\pm 1.0\text{mm}$ (0.04")

PULSE RISE TIME (dv/dt) Volts per μsec .

Rated Voltage	LEAD SPACING mm (inches)			
	10.0 (0.40)	15.0 (0.60)	22.5 (0.89)	27.0 (1.06)
100	6	3	2	1
250	11	7	4	3
400	20	10	5.5	5
630	30	15	8	7

Sharma Film Capacitors

MKTD01 SERIES CASE DIMENSIONS

Case Dimensions in Millimeters 100V • 250V • 400V • 630V

Capacitance in μF	VOLTAGE DC/AC							
	100 V DC / 63 V AC				250 V DC / 160 V AC			
	Dimensions in Millimeters				Dimensions in Millimeters			
	L	H	T	S	L	H	T	S
0.01					12.5	8.5	4.5	10.0
0.015					12.5	9.0	4.5	10.0
0.022					12.5	9.0	4.5	10.0
0.033					12.5	9.0	4.5	10.0
0.047					12.5	9.5	5.0	10.0
0.068					12.5	9.5	5.0	10.0
0.1	12.5	9.5	5.0	10.0	12.5	10.0	5.5	10.0
0.15	12.5	10.0	5.0	10.0	18.0	10.5	5.5	15.0
0.22	12.5	10.0	5.5	10.0	18.0	11.5	6.5	15.0
0.33	18.0	10.5	5.5	15.0	18.0	12.5	7.0	15.0
0.47	18.0	11.5	6.0	15.0	26.0	12.5	7.0	22.5
0.68	18.0	12.0	6.5	15.0	26.0	14.5	8.0	22.5
1.0	18.0	14.0	7.5	15.0	26.0	16.0	9.0	22.5
1.5	26.0	14.0	7.5	22.5	31.0	17.0	9.5	27.0
2.2	26.0	16.0	9.0	22.5	31.0	19.0	11.5	27.0
3.3	26.0	19.0	11.0	22.5	31.0	23.0	14.0	27.0
4.7	31.0	23.0	12.0	27.0	31.0	27.0	16.5	27.0
6.8	31.0	25.0	14.0	27.0				

Case Dimensions in Inches 100V • 250V • 400V • 630V

Capacitance in μF	VOLTAGE DC/AC							
	100 V DC / 63 V AC				250 V DC / 160 V AC			
	Dimensions in Inches				Dimensions in Inches			
	L	H	T	S	L	H	T	S
0.01					0.492	0.335	0.177	0.394
0.015					0.492	0.354	0.177	0.394
0.022					0.492	0.354	0.177	0.394
0.033					0.492	0.354	0.177	0.394
0.047					0.492	0.374	0.197	0.394
0.068					0.492	0.374	0.197	0.394
0.1	0.492	0.374	0.197	0.394	0.492	0.394	0.217	0.394
0.15	0.492	0.394	0.197	0.394	0.709	0.413	0.217	0.591
0.22	0.492	0.394	0.217	0.394	0.709	0.453	0.256	0.591
0.33	0.709	0.413	0.217	0.591	0.709	0.492	0.276	0.591
0.47	0.709	0.453	0.236	0.591	1.024	0.492	0.276	0.886
0.68	0.709	0.472	0.256	0.591	1.024	0.571	0.315	0.886
1.0	0.709	0.551	0.295	0.591	1.024	0.630	0.354	0.886
1.5	1.024	0.551	0.295	0.886	1.220	0.669	0.374	1.063
2.2	1.024	0.630	0.354	0.886	1.220	0.748	0.453	1.063
3.3	1.024	0.748	0.433	0.886	1.220	0.906	0.551	1.063
4.7	1.220	0.906	0.472	1.063	1.220	1.063	0.650	1.063
6.8	1.220	0.984	0.551	1.063				

Capacitance in μF	VOLTAGE DC/AC							
	400 V DC / 200 V AC				630 V DC / 220 V AC			
	Dimensions in Millimeters				Dimensions in Millimeters			
	L	H	T	S	L	H	T	S
0.01	12.5	9.0	4.5	10.0	12.5	9.0	4.5	10.0
0.015	12.5	9.5	4.5	10.0	12.5	9.5	5.0	10.0
0.022	12.5	9.5	5.0	10.0	12.5	10.5	6.0	10.0
0.033	12.5	10.5	5.5	10.0	18.0	11.0	6.0	15.0
0.047	12.5	10.5	6.0	10.0	18.0	11.5	6.5	15.0
0.068	18.0	10.5	6.0	15.0	18.0	12.5	7.0	15.0
0.1	18.0	11.5	6.5	15.0	26.0	13.0	7.0	22.5
0.15	26.0	12.5	6.0	22.5	26.0	14.0	8.5	22.5
0.22	26.0	13.5	7.0	22.5	26.0	16.5	10.0	22.5
0.33	26.0	15.5	8.5	22.5	31.0	17.5	10.5	27.0
0.47	26.0	18.0	9.5	22.5	31.0	19.5	12.0	27.0
0.68	31.0	17.5	10.0	27.0	31.0	22.5	15.0	27.0
1.0	31.0	20.0	12.0	27.0	31.0	27.5	19.0	27.0
1.5	31.0	23.5	13.5	27.0				
2.2	31.0	26.0	16.5	27.0				

Capacitance in μF	VOLTAGE DC/AC							
	400 V DC / 200 V AC				630 V DC / 220 V AC			
	Dimensions in Inches				Dimensions in Inches			
	L	H	T	S	L	H	T	S
0.01	0.492	0.354	0.177	0.394	0.492	0.354	0.177	0.394
0.015	0.492	0.374	0.177	0.394	0.492	0.374	0.197	0.394
0.022	0.492	0.374	0.197	0.394	0.492	0.413	0.236	0.394
0.033	0.492	0.413	0.217	0.394	0.709	0.433	0.236	0.591
0.047	0.492	0.413	0.236	0.394	0.709	0.453	0.256	0.591
0.068	0.709	0.413	0.236	0.591	0.709	0.492	0.276	0.591
0.1	0.709	0.453	0.256	0.591	1.024	0.512	0.276	0.886
0.15	1.024	0.492	0.236	0.886	1.024	0.551	0.335	0.886
0.22	1.024	0.531	0.276	0.886	1.024	0.650	0.394	0.886
0.33	1.024	0.610	0.335	0.886	1.220	0.689	0.413	1.063
0.47	1.024	0.709	0.374	0.886	1.220	0.768	0.472	1.063
0.68	1.220	0.689	0.394	1.063	1.220	0.886	0.591	1.063
1.0	1.220	0.787	0.472	1.063	1.220	1.083	0.748	1.063
1.5	1.220	0.925	0.531	1.063				
2.2	1.220	1.024	0.650	1.063				

MKT D02 SERIES

Formerly MPD 2 series

INTRODUCTION:

The MKTD02 Series Metallized Polyester Film Capacitors cover a wide range of values and voltages. This series has lead spacing starting from 7.5mm. and covers more values than the conventional series. They are suitable for applications such as Blocking, Bypassing and Coupling and are widely used in General communication equipment.

FEATURES:

- Wide value and Voltage range
- Self healing capability
- Flame retardant powder epoxy encapsulation
- Minimum overall dimensions due to dip coated construction

GENERAL SPECIFICATIONS:

Dissipation factor: < 0.0100 at 1 K Hz for capacitance $\leq 1.0 \mu\text{F}$, < 0.0150 at 1 K Hz for capacitance > 1.0 μF . **Insulation resistance:** For 100 VDC rated parts; $\geq 9,000 \text{ M Ohms for } \leq 0.33 \mu\text{F}$, $\geq 3,000 \text{ seconds for } C > 0.33 \mu\text{F}$ at a temperature of $25 \pm 5 \text{ }^\circ\text{C}$. For 250 to 630 VDC rated parts $\geq 15,000 \text{ M Ohms for } \leq 0.33 \mu\text{F}$, $\geq 5,000 \text{ seconds for } C > 0.33 \mu\text{F}$ at a temperature of $25 \pm 5 \text{ }^\circ\text{C}$. **Capacitance tolerance:** $\pm 5\%$ (J), $\pm 10\%$ (K) and $\pm 20\%$ (M) **Voltage Test :** 1.6 times the rated voltage applied between terminals for 2 seconds. at a temperature of $25 \pm 5 \text{ }^\circ\text{C}$. **Temperature range:** -55 to $85 \text{ }^\circ\text{C}$ **Climatic category:** F M F

LIFE TEST DETAILS:

Capacitors shall withstand 125% DC rated voltage or 100% AC rated voltage applied at $85 \text{ }^\circ\text{C}$ for 1000 hours. After the test:

1. Capacitance change shall remain within $\pm 5\%$.
2. Dissipation Factor shall be within 1.5 times the original limits.
3. Insulation Resistance shall be above 50% of the initial limits.
4. There shall be no remarkable change in the appearance and the marking shall remain legible.

DIMENSIONS AND TOLERANCES:

d - 0.6 mm (0.024")
for
Lead Spacing "s" =
10.0 mm (0.40")
d - 0.8 mm (0.032")
for
Lead Spacing "s" >
10.0 mm (0.40")
z - 1.5mm (0.06")
max.
LL" - 20.0 mm min.(0.78")
Tolerance on "s" $\pm 1.0\text{mm}$ (0.04")

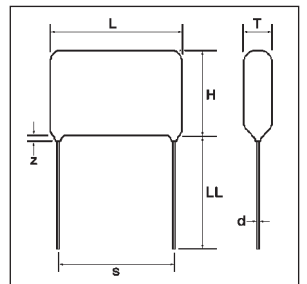

PULSE RISE TIME (dv/dt) Volts per μsec .

Rated Voltage	LEAD SPACING mm (inches)				
	7.5 (0.30)	10.0 (0.40)	15.0 (0.60)	22.5 (0.89)	27.5 (1.08)
100	6	6	3	2	1
250	15	11	7	4	3
400	30	20	10	5.5	5
630	40	30	15	8	7

Sharma Film Capacitors

MKT D02 SERIES CASE DIMENSIONS

Case Dimensions in Millimeters 100V • 250V • 400V • 630V

Capacitance in µF	VOLTAGE DC/AC							
	100 V DC / 63 V AC				250 V DC / 160 V AC			
	Dimensions in Millimeters							
	L	H	T	S	L	H	T	S
0.01					10.5	7.5	5.0	7.5
0.012					10.5	8.0	4.5	7.5
0.015					10.5	8.0	4.5	7.5
0.018					10.5	8.0	4.5	7.5
0.022	10.5	7.5	4.5	7.5	10.5	8.0	4.5	7.5
0.027	10.5	7.5	4.5	7.5	10.5	8.5	5.0	7.5
0.033	10.5	7.5	4.5	7.5	10.5	9.0	5.5	7.5
0.039	10.5	7.5	4.5	7.5	10.5	9.0	5.5	7.5
0.047	10.5	7.5	4.5	7.5	13.0	9.5	5.5	10.0
0.056	10.5	7.5	4.5	7.5	13.0	10.0	6.0	10.0
0.068	10.5	7.5	4.5	7.5	18.0	9.5	5.5	15.0
0.082	10.5	7.5	4.5	7.5	18.0	10.5	5.5	15.0
0.1	10.5	7.5	4.5	7.5	18.0	11.0	6.0	15.0
0.12	10.5	8.5	5.0	7.5	18.0	11.5	6.5	15.0
0.15	10.5	9.0	5.5	7.5	18.0	12.0	7.0	15.0
0.18	13.0	9.0	4.5	10.0	18.0	12.5	7.5	15.0
0.22	13.0	9.5	5.0	10.0	21.0	11.5	6.5	17.5
0.27	13.0	9.5	5.5	10.0	21.0	12.0	7.0	17.5
0.33	13.0	10.0	6.0	10.0	21.0	12.5	8.0	17.5
0.39	13.0	10.5	6.5	10.0	21.0	13.5	8.0	17.5
0.47	13.0	11.0	7.0	10.0	21.0	14.5	8.0	17.5
0.56	18.0	10.5	5.5	15.0	29.0	14.0	7.5	25.0
0.68	18.0	11.0	6.0	15.0	29.0	15.0	8.0	25.0
0.82	18.0	11.5	6.5	15.0	29.0	15.5	9.0	25.0
1.0	18.0	12.0	7.0	15.0	29.0	18.5	9.0	25.0
1.2	18.0	13.0	7.5	15.0	29.0	19.5	9.5	25.0
1.5	18.0	14.0	8.5	15.0	29.0	20.5	10.5	25.0
1.8	21.0	14.0	8.5	17.5	29.0	21.5	12.0	25.0
2.2	21.0	15.0	9.0	17.5	29.0	22.5	13.0	25.0
2.7	21.0	16.0	10.0	17.5				
3.3	21.0	17.5	10.5	17.5				
3.9	21.0	18.5	11.0	17.5				

Case Dimensions in Inches 100V • 250V • 400V • 630V

CAPACITANCE in µF	VOLTAGE DC/AC							
	100 V DC / 63 V AC				250 V DC / 160 V AC			
	Dimensions in Inches							
	L	H	T	S	L	H	T	S
0.01					0.413	0.295	0.197	0.295
0.012					0.413	0.315	0.177	0.295
0.015					0.413	0.315	0.177	0.295
0.018					0.413	0.315	0.177	0.295
0.022	0.413	0.295	0.177	0.295	0.413	0.315	0.177	0.295
0.027	0.413	0.295	0.177	0.295	0.413	0.335	0.197	0.295
0.033	0.413	0.295	0.177	0.295	0.413	0.354	0.217	0.295
0.039	0.413	0.295	0.177	0.295	0.413	0.354	0.217	0.295
0.047	0.413	0.295	0.177	0.295	0.512	0.374	0.217	0.394
0.056	0.413	0.295	0.177	0.295	0.512	0.394	0.236	0.394
0.068	0.413	0.295	0.177	0.295	0.709	0.374	0.217	0.591
0.082	0.413	0.295	0.177	0.295	0.709	0.413	0.217	0.591
0.1	0.413	0.295	0.177	0.295	0.709	0.433	0.236	0.591
0.12	0.413	0.335	0.197	0.295	0.709	0.453	0.256	0.591
0.15	0.413	0.354	0.217	0.295	0.709	0.472	0.276	0.591
0.18	0.512	0.354	0.177	0.394	0.709	0.492	0.295	0.591
0.22	0.512	0.374	0.197	0.394	0.827	0.453	0.256	0.689
0.27	0.512	0.374	0.217	0.394	0.827	0.472	0.276	0.689
0.33	0.512	0.394	0.236	0.394	0.827	0.492	0.315	0.689
0.39	0.512	0.413	0.256	0.394	0.827	0.531	0.315	0.689
0.47	0.512	0.433	0.276	0.394	0.827	0.571	0.315	0.689
0.56	0.709	0.413	0.217	0.591	1.142	0.551	0.295	0.984
0.68	0.709	0.433	0.236	0.591	1.142	0.591	0.315	0.984
0.82	0.709	0.453	0.256	0.591	1.142	0.610	0.354	0.984
1.0	0.709	0.472	0.276	0.591	1.142	0.728	0.354	0.984
1.2	0.709	0.512	0.295	0.591	1.142	0.768	0.374	0.984
1.5	0.709	0.551	0.335	0.591	1.142	0.807	0.413	0.984
1.8	0.827	0.551	0.335	0.689	1.142	0.846	0.472	0.984
2.2	0.827	0.591	0.354	0.689	1.142	0.886	0.512	0.984
2.7	0.827	0.630	0.394	0.689				
3.3	0.827	0.689	0.413	0.689				
3.9	0.827	0.728	0.433	0.689				

CAPACITANCE in µF	VOLTAGE DC/AC							
	400 V DC / 200 V AC				630 V DC / 220 V AC			
	Dimensions in Millimeters							
	L	H	T	S	L	H	T	S
0.01	10.5	7.5	5.0	7.5	18.0	8.5	5.0	15.0
0.012	10.5	8.0	4.5	7.5	18.0	8.5	4.5	15.0
0.015	10.5	8.0	4.5	7.5	18.0	9.0	5.0	15.0
0.018	18.0	8.0	4.5	15.0	18.0	9.5	5.5	15.0
0.022	18.0	8.5	4.5	15.0	18.0	10.5	5.5	15.0
0.027	18.0	9.0	5.0	15.0	18.0	10.5	6.5	15.0
0.033	18.0	9.5	5.5	15.0	18.0	11.0	7.0	15.0
0.039	18.0	10.0	6.0	15.0	21.0	10.5	6.0	17.5
0.047	18.0	10.5	6.5	15.0	21.0	11.0	6.0	17.5
0.056	18.0	11.0	7.0	15.0	21.0	11.5	6.5	17.5
0.068	18.0	11.5	7.5	15.0	21.0	12.0	7.0	17.5
0.082	21.0	11.0	6.0	17.5	21.0	12.5	8.0	17.5
0.1	21.0	11.5	6.5	17.5	21.0	14.5	8.5	17.5
0.12	21.0	12.0	7.0	17.5	21.0	15.5	9.0	17.5
0.15	21.0	13.0	8.0	17.5	29.0	14.0	8.5	25.0
0.18	21.0	14.5	8.0	17.5	29.0	15.5	9.0	25.0
0.22	21.0	15.0	8.5	17.5	29.0	16.0	9.0	25.0
0.27	21.0	16.0	9.5	17.5	29.0	18.5	9.0	25.0
0.33	29.0	15.0	8.5	25.0	31.0	19.0	9.5	27.5
0.39	29.0	16.0	9.5	25.0	31.0	20.0	10.5	27.5
0.47	29.0	16.5	10.0	25.0	31.0	21.0	11.5	27.5
0.56	29.0	19.5	10.0	25.0				
0.68	29.0	20.5	11.0	25.0				
0.82	29.0	21.5	12.0	25.0				
1.0	29.0	23.0	13.0	25.0				

CAPACITANCE in µF	VOLTAGE DC/AC							
	400 V DC / 200 V AC				630 V DC / 220 V AC			
	Dimensions in Inches							
	L	H	T	S	L	H	T	S
0.01	0.413	0.295	0.197	0.295	0.709	0.335	0.197	0.591
0.012	0.413	0.315	0.177	0.295	0.709	0.335	0.177	0.591
0.015	0.413	0.315	0.177	0.295	0.709	0.354	0.197	0.591
0.018	0.709	0.315	0.177	0.591	0.709	0.374	0.217	0.591
0.022	0.709	0.335	0.177	0.591	0.709	0.413	0.217	0.591
0.027	0.709	0.354	0.197	0.591	0.709	0.413	0.256	0.591
0.033	0.709	0.374	0.217	0.591	0.709	0.433	0.276	0.591
0.039	0.709	0.394	0.236	0.591	0.827	0.413	0.236	0.689
0.047	0.709	0.413	0.256	0.591	0.827	0.433	0.236	0.689
0.056	0.709	0.433	0.276	0.591	0.827	0.453	0.256	0.689
0.068	0.709	0.453	0.295	0.591	0.827	0.472	0.276	0.689
0.082	0.827	0.433	0.236	0.689	0.827	0.492	0.315	0.689
0.1	0.827	0.453	0.256	0.689	0.827	0.571	0.335	0.689
0.12	0.827	0.472	0.276	0.689	0.827	0.610	0.354	0.689
0.15	0.827	0.512	0.315	0.689	1.142	0.551	0.335	0.984
0.18	0.827	0.571	0.315	0.689	1.142	0.610	0.354	0.984
0.22	0.827	0.591	0.335	0.689	1.142	0.630	0.354	0.984
0.27	0.827	0.630	0.374	0.689	1.142	0.728	0.354	0.984
0.33	1.142	0.591	0.335	0.984	1.220	0.748	0.374	1.083
0.39	1.142	0.630	0.374	0.984	1.220	0.787	0.413	1.083
0.47	1.142	0.650	0.394	0.984	1.220	0.827	0.453	1.083
0.56	1.142	0.768	0.394	0.984				
0.68	1.142	0.807	0.433	0.984				
0.82	1.142	0.846	0.472	0.984				
1.0	1.142	0.906	0.512	0.984				

Sharma Film Capacitors

MKT D03 SERIES

Formerly MPD 3 series

INTRODUCTION:

The MKTD03 Series Metallized Polyester Film Capacitors cover a wide range of values and voltages. This series provides alternative dimensions for the same values covered by the other MKTD series. These capacitors are suitable for applications such as Blocking, By-passing and Coupling and are widely used in General communication equipment.

FEATURES:

- Wide value and Voltage range
- Self healing capability
- Flame retardant powder epoxy encapsulation
- Minimum overall dimensions due to dip coated construction

GENERAL SPECIFICATIONS:

Dissipation factor: < 0.0100 at 1 K Hz for capacitance ≤ 1.0 μF, < 0.0150 at 1 K Hz for capacitance > 1.0 μF. **Insulation resistance:** For 100 VDC rated parts; ≥ 9,000 M Ohms for C ≤ 0.33 μF, ≥ 3,000 seconds for C > 0.33 μF at a temperature of 25 ± 5 °C. For 250 to 630 VDC rated parts; ≥ 15,000 M Ohms for C ≤ 0.33 μF, ≥ 5,000 seconds for C > 0.33 μF at a temperature of 25 ± 5 °C. **Capacitance tolerance:** ±5%(J), ±10%(K) and ±20%(M). **Voltage Test :** 1.6 times the rated voltage applied between terminals for 2 seconds. at a temperature of 25 ± 5 °C. **Temperature range:** -55 to 85 °C. **Climatic category:** F M F

LIFE TEST DETAILS:

Capacitors shall withstand 125% DC rated voltage or 100% AC rated voltage applied at 85 °C for 1000 hours. After the test:

1. Capacitance change shall remain within ±5%.
2. Dissipation Factor shall be within 1.5 times the original limits.
3. Insulation Resistance shall be above 50% of the initial limits.
4. There shall be no remarkable change in the appearance and the marking shall remain legible.

DIMENSIONS AND TOLERANCES:

d - 0.6 mm (0.024") for Lead Spacing "s" = 10.0 mm (0.40")
 d - 0.8 mm (0.032") for Lead Spacing "s" > 10.0 mm (0.40")
 z - 1.5mm (0.06") max.
 LL" - 20.0 mm min.(0.78")

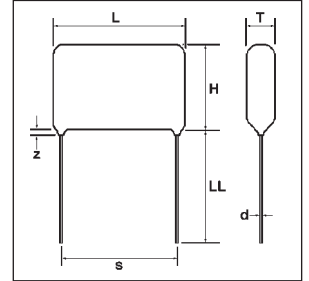

Tolerance on "s" ± 1.0mm (0.04") for s ≤ 15mm(0.6").
 Tolerance on "s" ± 1.5mm (0.06") for s ≤ 20mm(0.78").
 Tolerance on "s" ± 2.0mm (0.08") for s ≤ 27.5mm(1.08").

PULSE RISE TIME (dv/dt) Volts per usec.

Rated Voltage	LEAD SPACING mm (inches)			
	10.0 (0.40)	15.0 (0.60)	22.5 (0.89)	27.0 (1.06)
100	6	3	2	1
250	11	7	4	3
400	20	10	5.5	5
630	30	15	8	7

Case Dimensions in Millimeters 100V • 250V • 400V • 630V

Capacitance in μF	VOLTAGE DC/AC							
	100 V DC / 63 V AC				250 V DC / 160 V AC			
	Dimensions in Millimeters				Dimensions in Millimeters			
	L	H	T	S	L	H	T	S
0.01	13.0	10.0	5.5	10.0	13.0	10.0	5.5	10.0
0.015	13.0	10.0	6.0	10.0	13.0	10.0	6.0	10.0
0.022	13.0	10.0	6.0	10.0	13.0	10.0	6.0	10.0
0.033	13.0	10.0	6.0	10.0	13.0	10.0	6.0	10.0
0.047	13.0	10.0	6.0	10.0	13.0	10.0	6.0	10.0
0.068	13.0	11.0	6.5	10.0	13.0	11.0	6.5	10.0
0.1	13.0	12.5	7.0	10.0	13.0	12.5	7.0	10.0
0.15	13.0	12.5	8.0	10.0	13.0	12.5	8.0	10.0
0.22	13.0	12.5	8.0	10.0	18.0	13.0	7.0	15.0
0.33	13.5	14.0	9.0	10.0	18.0	14.0	8.0	15.0
0.47	13.5	15.0	10.0	10.0	18.0	16.0	9.5	15.0
0.68	18.0	13.5	8.0	15.0	24.0	14.0	9.5	20.0
1.0	18.0	16.5	9.5	15.0	24.0	18.0	10.5	20.0
1.5	18.0	19.0	11.5	15.0	24.0	23.0	13.5	20.0
2.2	24.0	21.0	12.5	20.0	30.0	23.0	13.5	27.5
3.3	24.0	22.0	13.0	20.0	30.0	24.0	16.5	27.5
4.7	30.0	23.5	14.0	27.5	33.0	24.0	18.0	30.0
6.8	30.0	24.0	15.5	27.5	33.0	26.0	20.0	30.0
10	30.0	26.0	21.5	27.5				

Case Dimensions in Inches 100V • 250V • 400V • 630V

Capacitance in μF	VOLTAGE DC/AC							
	100 V DC / 63 V AC				250 V DC / 160 V AC			
	Dimensions in Inches				Dimensions in Inches			
	L	H	T	S	L	H	T	S
0.01	0.512	0.394	0.217	0.394	0.512	0.394	0.217	0.394
0.015	0.512	0.394	0.236	0.394	0.512	0.394	0.236	0.394
0.022	0.512	0.394	0.236	0.394	0.512	0.394	0.236	0.394
0.033	0.512	0.394	0.236	0.394	0.512	0.394	0.236	0.394
0.047	0.512	0.394	0.236	0.394	0.512	0.394	0.236	0.394
0.068	0.512	0.433	0.256	0.394	0.512	0.433	0.256	0.394
0.1	0.512	0.492	0.276	0.394	0.512	0.492	0.276	0.394
0.15	0.512	0.492	0.315	0.394	0.512	0.492	0.315	0.394
0.22	0.512	0.492	0.315	0.394	0.709	0.512	0.276	0.591
0.33	0.531	0.551	0.354	0.394	0.709	0.551	0.315	0.591
0.47	0.531	0.591	0.394	0.394	0.709	0.630	0.374	0.591
0.68	0.709	0.531	0.315	0.591	0.945	0.551	0.374	0.787
1.0	0.709	0.650	0.374	0.591	0.945	0.709	0.413	0.787
1.5	0.709	0.748	0.453	0.591	0.945	0.906	0.531	0.787
2.2	0.945	0.827	0.492	0.787	1.181	0.906	0.531	1.083
3.3	0.945	0.866	0.512	0.787	1.181	0.945	0.650	1.083
4.7	1.181	0.925	0.551	1.083	1.299	0.945	0.709	1.181
6.8	1.181	0.945	0.610	1.083	1.299	1.024	0.787	1.181
10	1.181	1.024	0.846	1.083				

Capacitance in μF	VOLTAGE DC/AC							
	400 V DC / 200 V AC				630 V DC / 220 V AC			
	Dimensions in Millimeters				Dimensions in Millimeters			
	L	H	T	S	L	H	T	S
0.01	13.0	10.0	5.5	10.0	13.0	10.5	6.0	10.0
0.015	13.0	10.0	6.0	10.0	13.0	11.0	6.5	10.0
0.022	13.0	10.0	6.0	10.0	13.0	11.0	6.5	10.0
0.033	13.0	11.0	6.5	10.0	18.0	10.0	6.5	15.0
0.047	13.0	11.5	7.0	10.0	18.0	11.0	7.0	15.0
0.068	13.0	12.5	7.0	10.0	18.0	12.0	8.0	15.0
0.1	18.0	11.0	6.0	15.0	18.0	15.0	8.5	15.0
0.15	18.0	14.0	8.0	15.0	18.0	15.5	11.0	15.0
0.22	18.0	16.5	9.5	15.0	24.0	16.5	10.5	20.0
0.33	18.0	16.5	10.0	15.0	24.0	18.0	12.0	20.0
0.47	24.0	17.5	10.5	20.0	30.0	22.0	12.5	27.5
0.68	30.0	18.0	10.5	27.5	30.0	23.5	14.0	27.5
1.0	30.0	21.5	12.0	27.5	30.0	25.5	15.0	27.5
1.5	30.0	24.0	14.0	27.5	33.0	28.0	20.0	30.0
2.2	33.0	26.0	18.0	30.0				
3.3	33.0	28.0	21.0	30.0				

Capacitance in μF	VOLTAGE DC/AC							
	400 V DC / 200 V AC				630 V DC / 220 V AC			
	Dimensions in Inches				Dimensions in Inches			
	L	H	T	S	L	H	T	S
0.01	0.512	0.394	0.217	0.394	0.512	0.413	0.236	0.394
0.015	0.512	0.394	0.236	0.394	0.512	0.433	0.256	0.394
0.022	0.512	0.394	0.236	0.394	0.512	0.433	0.256	0.394
0.033	0.512	0.433	0.256	0.394	0.709	0.394	0.256	0.591
0.047	0.512	0.453	0.276	0.394	0.709	0.433	0.276	0.591
0.068	0.512	0.492	0.276	0.394	0.709	0.472	0.315	0.591
0.1	0.709	0.433	0.236	0.591	0.709	0.591	0.335	0.591
0.15	0.709	0.551	0.315	0.591	0.709	0.610	0.433	0.591
0.22	0.709	0.650	0.374	0.591	0.945	0.650	0.413	0.787
0.33	0.709	0.650	0.394	0.591	0.945	0.709	0.472	0.787
0.47	0.945	0.689	0.413	0.787	1.181	0.866	0.492	1.083
0.68	1.181	0.709	0.413	1.083	1.181	0.925	0.551	1.083
1.0	1.181	0.846	0.472	1.083	1.181	1.004	0.591	1.083
1.5	1.181	0.945	0.551	1.083	1.299	1.102	0.787	1.181
2.2	1.299	1.024	0.709	1.181				
3.3	1.299	1.102	0.827	1.181				

Sharma Film Capacitors

MKTD04 SERIES

Features

- Very small size, Epoxy coating, Flame retardant to UL94V-0 7.5mm Lead spacing.
- Self-healing metallized polyester dielectric, Non-inductive construction.
- High performance and efficiencies. Custom values, voltages, and case sizes available upon request.

Application

- Multi-purpose
- Blocking & coupling
- By-passing & Filtering, Timing



Specifications

Capacitance Range	0.001 μ F to 1.0 μ F
Operating temperature	-40 to +85°C (up to 100°C - derate voltage 1.25% per °C)
Rated Voltage	50/63, 100, 250, 400, 630, 1000V dc
Capacitance Tolerance	± 2 (G), ± 5 (J), ± 10 (K) %
Tangent of Loss Angle	0.008 or LESS (at 1KHz +25°C)
Insulation Resistance	Voltage Charge : 1 min at +25°C, $\pm 5^\circ$ C 50 Vdc for Vr<100Vdc, 100Vdc for Vr \geq 100Vdc 9,000 or more, c \leq 0.33 μ f 5000S or more c>0.33 μ f
Voltage Test	1.6 x Vr applied for 2sec +25°C, 5°C (Between Terminal)
Endurance	+85°C, $\pm 2^\circ$ C, 1.25 x Vr, 1000Hr Cap Change: < $\pm 5\%$, DF Change : <50x10 at 1khz Insulation Resistance: <50% of limit value
Damp Heat	+40°C $\pm 2^\circ$ C, 93% $\pm 2\%$, 21days Cap Change: < $\pm 5\%$, DF Change : <50x10 at 1khz Insulation Resistance: <50% of limit value
Construction	Non-inductive wound metallized polyester film Epoxy dipped encasement, Flame retardant to UL94V-0
Lead Material Color of Body Markings	Solder coated or Tinned solid wire Orange/Brown Capacitance, Tolerance, Voltage When space permits, Capacitor Type will be marked

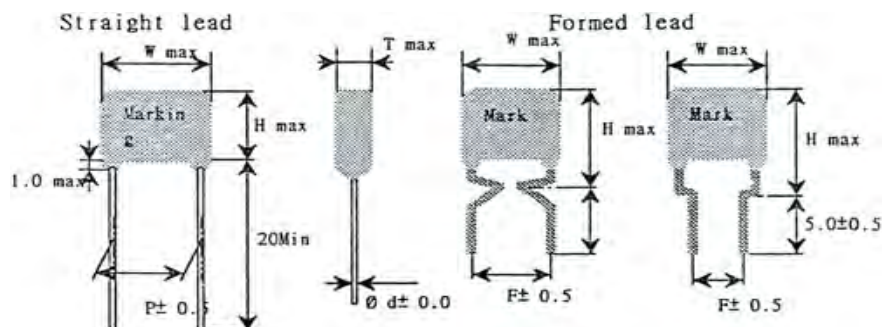

- Special size or items on request.
- Tolerance Dimension ± 0.5 mm.

Sharma Film Capacitors

Capacitance		50/63DC					100VDC					250VDC				
μF	code	T _{max}	H _{max}	W _{max}	P	d	T _{max}	H _{max}	W _{max}	P	d	T _{max}	H _{max}	W _{max}	P	d
0.0010	102	3.0	5.0	9.3	7.5	0.6	3.0	5.0	9.3	7.5	0.6	3.0	5.0	9.3	7.5	0.6
0.0012	122	3.0	5.0	9.3	7.5	0.6	3.0	5.0	9.3	7.5	0.6	3.0	5.0	9.3	7.5	0.6
0.0015	152	3.0	5.0	9.3	7.5	0.6	3.0	5.0	9.3	7.5	0.6	3.0	5.0	9.3	7.5	0.6
0.0018	182	3.0	5.0	9.3	7.5	0.6	3.0	5.0	9.3	7.5	0.6	3.0	5.0	9.3	7.5	0.6
0.0022	222	3.0	5.0	9.3	7.5	0.6	3.0	5.0	9.3	7.5	0.6	3.0	5.0	9.3	7.5	0.6
0.0027	272	3.0	5.0	9.3	7.5	0.6	3.0	5.0	9.3	7.5	0.6	3.0	5.0	9.3	7.5	0.6
0.0033	332	3.0	5.0	9.3	7.5	0.6	3.0	5.0	9.3	7.5	0.6	3.0	5.0	9.3	7.5	0.6
0.0039	392	3.0	5.0	9.3	7.5	0.6	3.0	5.0	9.3	7.5	0.6	3.0	5.0	9.3	7.5	0.6
0.0047	472	3.0	5.0	9.3	7.5	0.6	3.0	5.0	9.3	7.5	0.6	3.0	5.0	9.3	7.5	0.6
0.0056	562	3.0	5.0	9.3	7.5	0.6	3.0	5.0	9.3	7.5	0.6	3.0	5.0	9.3	7.5	0.6
0.0068	682	3.0	5.0	9.3	7.5	0.6	3.0	5.0	9.3	7.5	0.6	3.0	5.0	9.3	7.5	0.6
0.0082	822	3.0	5.0	9.3	7.5	0.6	3.0	5.0	9.3	7.5	0.6	3.0	5.0	9.3	7.5	0.6
0.010	103	3.0	5.0	9.3	7.5	0.6	3.0	5.0	9.3	7.5	0.6	3.0	5.0	9.3	7.5	0.6
0.012	123	3.0	5.0	9.3	7.5	0.6	3.0	5.0	9.3	7.5	0.6	3.0	5.0	9.3	7.5	0.6
0.015	153	3.0	5.0	9.3	7.5	0.6	3.0	5.0	9.3	7.5	0.6	3.0	5.0	9.3	7.5	0.6
0.018	183	3.0	5.0	9.3	7.5	0.6	3.0	5.0	9.3	7.5	0.6	3.0	5.0	9.3	7.5	0.6
0.022	223	3.0	5.0	9.3	7.5	0.6	3.0	5.0	9.3	7.5	0.6	3.0	5.0	9.3	7.5	0.6
0.027	273	3.0	5.0	9.3	7.5	0.6	3.0	5.0	9.3	7.5	0.6	3.0	5.0	9.3	7.5	0.6
0.033	333	3.0	5.2	9.3	7.5	0.6	3.0	5.2	9.3	7.5	0.6	3.0	5.2	9.3	7.5	0.6
0.039	393	3.0	5.2	9.3	7.5	0.6	3.0	5.2	9.3	7.5	0.6	-	-	-	-	-
0.047	473	3.0	5.2	9.3	7.5	0.6	3.0	5.2	9.3	7.5	0.6	-	-	-	-	-
0.056	563	3.0	5.2	9.3	7.5	0.6	3.0	5.2	9.3	7.5	0.6	-	-	-	-	-
0.068	683	3.0	5.2	9.3	7.5	0.6	3.0	5.2	9.3	7.5	0.6	-	-	-	-	-
0.082	823	3.0	5.2	9.3	7.5	0.6	3.0	5.2	9.3	7.5	0.6	-	-	-	-	-
0.10	104	3.0	5.2	9.3	7.5	0.6	3.0	5.2	9.3	7.5	0.6	-	-	-	-	-
0.12	124	3.0	5.5	9.3	7.5	0.6	3.0	5.5	9.3	7.5	0.6	-	-	-	-	-
0.15	154	3.0	6.0	9.3	7.5	0.6	3.0	6.0	9.3	7.5	0.6	-	-	-	-	-
0.18	184	3.3	6.5	9.3	7.5	0.6	3.3	6.5	9.3	7.5	0.6	-	-	-	-	-
0.22	224	3.5	6.5	9.3	7.5	0.6	3.5	6.5	9.3	7.5	0.6	-	-	-	-	-
0.27	274	4.0	7.0	9.3	7.5	0.6	4.0	7.0	9.3	7.5	0.6	-	-	-	-	-
0.33	334	4.0	7.5	9.3	7.5	0.6	4.0	7.5	9.3	7.5	0.6	-	-	-	-	-
0.39	394	4.5	7.8	9.3	7.5	0.6	4.5	7.8	9.3	7.5	0.6	-	-	-	-	-
0.47	474	4.8	8.0	9.3	7.5	0.6	4.8	8.0	9.3	7.5	0.6	-	-	-	-	-
0.56	564	5.0	9.0	9.3	7.5	0.6	5.0	9.0	9.3	7.5	0.6	-	-	-	-	-
0.68	684	5.2	9.2	9.3	7.5	0.6	5.2	9.2	9.3	7.5	0.6	-	-	-	-	-
0.82	824	5.8	10.8	9.3	7.5	0.6	5.8	10.8	9.3	7.5	0.6	-	-	-	-	-
1.0	105	5.8	10.8	9.3	7.5	0.6	5.8	10.8	9.3	7.5	0.6	-	-	-	-	-

Sharma Film Capacitors

Capacitance		400V DC					630V DC					1000V DC				
μF	code	T _{max}	H _{max}	W _{max}	P	d	T _{max}	H _{max}	W _{max}	P	d	T _{max}	H _{max}	W _{max}	P	d
0.0010	102	3.0	5.0	9.3	7.5	0.6	3.0	5.0	9.3	7.5	0.6	3.0	5.0	9.3	7.5	0.6
0.0012	122	3.0	5.0	9.3	7.5	0.6	3.0	5.0	9.3	7.5	0.6	3.0	5.0	9.3	7.5	0.6
0.0015	152	3.0	5.0	9.3	7.5	0.6	3.0	5.0	9.3	7.5	0.6	3.0	5.0	9.3	7.5	0.6
0.0018	182	3.0	5.0	9.3	7.5	0.6	3.0	5.0	9.3	7.5	0.6	-	-	-	-	-
0.0022	222	3.0	5.0	9.3	7.5	0.6	3.0	5.0	9.3	7.5	0.6	-	-	-	-	-
0.0027	272	3.0	5.0	9.3	7.5	0.6	-	-	-	-	-	-	-	-	-	-
0.0033	332	3.0	5.0	9.3	7.5	0.6	-	-	-	-	-	-	-	-	-	-
0.0039	392	3.0	5.0	9.3	7.5	0.6	-	-	-	-	-	-	-	-	-	-
0.0047	472	3.0	5.0	9.3	7.5	0.6	-	-	-	-	-	-	-	-	-	-
0.0056	562	3.0	5.0	9.3	7.5	0.6	-	-	-	-	-	-	-	-	-	-
0.0068	682	3.0	5.0	9.3	7.5	0.6	-	-	-	-	-	-	-	-	-	-
0.0082	822	-	-	-	7.5	0.6	-	-	-	-	-	-	-	-	-	-
0.010	103	-	-	-	-	-	-	-	-	-	-	-	-	-	-	-
0.012	123	-	-	-	-	-	-	-	-	-	-	-	-	-	-	-
0.015	153	-	-	-	-	-	-	-	-	-	-	-	-	-	-	-
0.018	183	-	-	-	-	-	-	-	-	-	-	-	-	-	-	-
0.022	223	-	-	-	-	-	-	-	-	-	-	-	-	-	-	-
0.027	273	-	-	-	-	-	-	-	-	-	-	-	-	-	-	-
0.033	333	-	-	-	-	-	-	-	-	-	-	-	-	-	-	-
0.039	393	-	-	-	-	-	-	-	-	-	-	-	-	-	-	-
0.047	473	-	-	-	-	-	-	-	-	-	-	-	-	-	-	-
0.056	563	-	-	-	-	-	-	-	-	-	-	-	-	-	-	-
0.068	683	-	-	-	-	-	-	-	-	-	-	-	-	-	-	-
0.082	823	-	-	-	-	-	-	-	-	-	-	-	-	-	-	-
0.10	104	-	-	-	-	-	-	-	-	-	-	-	-	-	-	-
0.12	124	-	-	-	-	-	-	-	-	-	-	-	-	-	-	-
0.15	154	-	-	-	-	-	-	-	-	-	-	-	-	-	-	-
0.18	184	-	-	-	-	-	-	-	-	-	-	-	-	-	-	-
0.22	224	-	-	-	-	-	-	-	-	-	-	-	-	-	-	-
0.27	274	-	-	-	-	-	-	-	-	-	-	-	-	-	-	-
0.33	334	-	-	-	-	-	-	-	-	-	-	-	-	-	-	-
0.39	394	-	-	-	-	-	-	-	-	-	-	-	-	-	-	-
0.47	474	-	-	-	-	-	-	-	-	-	-	-	-	-	-	-
0.56	564	-	-	-	-	-	-	-	-	-	-	-	-	-	-	-
0.68	684	-	-	-	-	-	-	-	-	-	-	-	-	-	-	-
0.82	824	-	-	-	-	-	-	-	-	-	-	-	-	-	-	-
1.0	105	-	-	-	-	-	-	-	-	-	-	-	-	-	-	-

Sharma Film Capacitors

Taping Specifications For Automatic Insertion

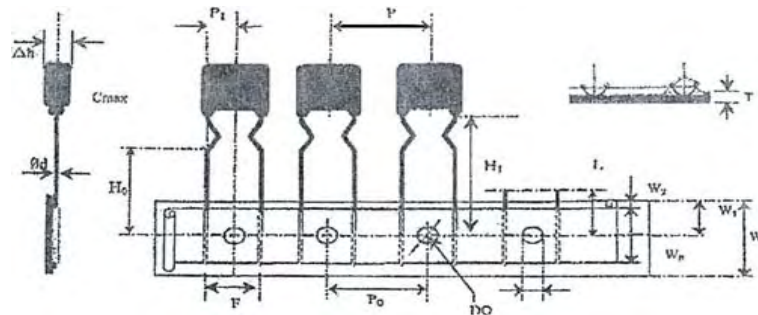

Description	Symbol	Dimensions (mm)	
		Lead Spacing 7.5mm	Toll
Lead wire diameter	Φd	0.6	± 0.05
Taping pitch	P	12.7	± 0.1
Sprocket hole pitch	P0	12.7	± 0.2
Centering of the lead wire	P	3.75	± 0.5
Centering of the body	P2	0	-
Lead spacing	F	7.5	± 0.8
Component alignment	Δh	0	± 2.0
Height from sprocket hole	H1	20.0	± 0.5
Height	H	16.0	± 0.5
Center to the comp body	L	11.0	± 0.5
Tape width	W	18.0	+1.0-0.5
Width of adhesive tape	W0	13.0	± 0.5
Sprocket hole alignment	W1	9.0	± 0.5
Position of adhesive tape	W2	3max	
Sprocket hole diameter	D0	4.0	± 0.2
Tape thickness	T	0.7	± 0.2

Standard Packing Quantity For Box



Sharma Film Capacitors

50-100V		250V		400V		630V		1000V	
102-124 values	1800PCS	102-273 values	2000PCS	102-822 values	2000PCS	102-392 values	2000PCS	102-182 values	2000PCS
154-224 values	1500PCS	333-524 values	1500PCS	103-223 values	1500PCS	472-822 values	1500PCS	222-332 values	1500PCS
274-474 values	1200PCS	154-184 values	1200PCS	273-393 values	1200PCS	103-123 values	1200PCS	392-822 values	1200PCS
564-824 values	1000PCS	224-274 values	1000PCS	473-563 values	1000PCS	153-223 values	1000PCS	103 value	1000PCS
-	-	334-474 values	800PCS	683-823 values	800PCS	273-333 values	800PCS	-	-
-	-	564-684 values	700PCS	104 value	700PCS	393 value	700PCS	-	-

Sharma Film Capacitors

MKTD05 SERIES

Features

- Very small size, Epoxy coating, Flame retardant to UL94V-0 5mm Lead spacing.
- Self-healing metallized polyester dielectric, Non-inductive construction.
- High performance and efficiencies. Custom values, voltages, and case sizes available upon request.

Application

- Multi-purpose
- Blocking & coupling
- By-passing & Filtering, Timing



Specifications

Capacitance Range	0.001 μ F to 1.0 μ F
Operating Temperature	-40 to +85°C (up to 100°C - derate voltage 1.25% per °C)
Rated Voltage	50/63, 100, 250, 400, 630V DC
Capacitance Tolerance	± 2 (G), ± 5 (J), ± 10 (K) %
Tangent of Loss Angle	0.008 or LESS (at 1KHz +25°C)
Insulation Resistance	Voltage Charge : 1 min at +25°C, $\pm 5^\circ$ C 50 Vdc for Vr<100Vdc, 100Vdc for Vr \geq 100Vdc 9,000 or more, c \leq 0.33 μ f 5000S or more c>0.33 μ f
Voltage Test	1.6 x Vr applied for 2sec +25°C, 5°C (Between Terminal)
Endurance	+85°C, $\pm 2^\circ$ C, 1.25 x Vr, 1000Hr Cap Change: < $\pm 5\%$, DF Change : <50x10 at 1khz Insulation Resistance: <50% of limit value
Damp Heat	+40°C $\pm 2^\circ$ C, 93% $\pm 2\%$, 21days Cap Change: < $\pm 5\%$, DF Change : <50x10 at 1khz Insulation Resistance: <50% of limit value
Construction	Non-inductive wound metallized polyester film Epoxy dipped encasement, Flame retardant to UL94V-0
Lead Material Color of Body Markings	Solder coated or Tinned solid wire Orange/Brown Capacitance, Tolerance, Voltage When space permits, Capacitor Type will be marked

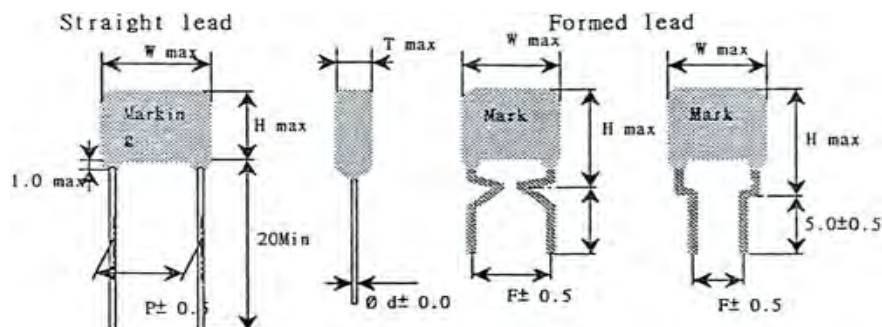

- Special size or items on request.
- Tolerance Dimension ± 0.5 mm.

Sharma Film Capacitors

Capacitance		50/63VDC					100VDC				
μF	code	T _{max}	H _{max}	W _{max}	P	d	T _{max}	H _{max}	W _{max}	P	d
0.001	102	3.2	5.0		5.0	0.5	3.2	5.0	6.8	5.0	0.5
0.0012	122	3.2	5.0	6.8	5.0	0.5	3.2	5.0	6.8	5.0	0.5
0.0015	152	3.2	5.0	6.8	5.0	0.5	3.2	5.0	6.8	5.0	0.5
0.0018	182	3.2	5.0	6.8	5.0	0.5	3.2	5.0	6.8	5.0	0.5
0.0022	222	3.2	5.0	6.8	5.0	0.5	3.2	5.0	6.8	5.0	0.5
0.0027	272	3.2	5.0	6.8	5.0	0.5	3.2	5.0	6.8	5.0	0.5
0.0033	332	3.2	5.0	6.8	5.0	0.5	3.2	5.0	6.8	5.0	0.5
0.0039	392	3.2	5.0	6.8	5.0	0.5	3.2	5.0	6.8	5.0	0.5
0.0047	472	3.2	5.0	6.8	5.0	0.5	3.2	5.0	6.8	5.0	0.5
0.0056	562	3.2	5.0	6.8	5.0	0.5	3.2	5.0	6.8	5.0	0.5
0.0068	682	3.2	5.0	6.8	5.0	0.5	3.2	5.0	6.8	5.0	0.5
0.0082	822	3.2	5.0	6.8	5.0	0.5	3.2	5.0	6.8	5.0	0.5
0.010	103	3.2	5.0	6.8	5.0	0.5	3.2	5.0	6.8	5.0	0.5
0.012	123	3.2	5.0	6.8	5.0	0.5	3.2	5.0	6.8	5.0	0.5
0.015	153	3.2	5.0	6.8	5.0	0.5	3.2	5.0	6.8	5.0	0.5
0.018	183	3.2	5.0	6.8	5.0	0.5	3.2	5.0	6.8	5.0	0.5
0.022	223	3.2	5.0	6.8	5.0	0.5	3.2	5.0	6.8	5.0	0.5
0.027	273	3.2	5.0	6.8	5.0	0.5	3.2	5.0	6.8	5.0	0.5
0.033	333	3.2	5.0	6.8	5.0	0.5	3.2	5.0	6.8	5.0	0.5
0.039	393	3.2	5.0	6.8	5.0	0.5	3.2	5.0	6.8	5.0	0.5
0.047	473	3.2	5.0	6.8	5.0	0.5	3.2	5.0	6.8	5.0	0.5
0.056	563	3.2	5.0	6.8	5.0	0.5	3.2	5.0	6.8	5.0	0.5
0.068	683	3.2	5.3	6.8	5.0	0.5	3.2	5.3	6.8	5.0	0.5
0.082	823	3.2	5.3	6.8	5.0	0.5	3.2	5.3	6.8	5.0	0.5
0.10	104	3.2	5.5	6.8	5.0	0.5	3.2	5.5	6.8	5.0	0.5
0.12	124	3.2	5.5	6.8	5.0	0.5	3.2	5.5	6.8	5.0	0.5
0.15	154	3.5	6.5	6.8	5.0	0.5	3.5	6.5	6.8	5.0	0.5
0.18	184	4.0	7.0	6.8	5.0	0.5	4.0	7.0	6.8	5.0	0.5
0.22	224	4.0	7.0	6.8	5.0	0.5	4.0	7.0	6.8	5.0	0.5
0.27	274	4.3	8.0	6.8	5.0	0.5	4.3	8.0	6.8	5.0	0.5
0.33	334	4.8	8.0	6.8	5.0	0.5	4.8	8.0	6.8	5.0	0.5
0.39	394	5.0	9.0	6.8	5.0	0.5	5.0	9.0	6.8	5.0	0.5
0.47	474	5.5	9.5	6.8	5.0	0.5	5.5	9.5	6.8	5.0	0.5
0.56	564	5.8	9.5	6.8	5.0	0.5	5.8	9.5	6.8	5.0	0.5
0.68	684	6.3	10.5	6.8	5.0	0.5	6.3	10.5	6.8	5.0	0.5
0.82	824	6.3	10.5	6.8	5.0	0.5	6.3	10.5	6.8	5.0	0.5
1.0	105	6.3	10.5	6.8	5.0	0.5	6.3	10.5	6.8	5.0	0.5

Sharma Film Capacitors

Capacitance		250VDC					400VDC					630VDC				
μF	code	T _{max}	H _{max}	W _{max}	P	d	T _{max}	H _{max}	W _{max}	P	d	T _{max}	H _{max}	W _{max}	P	d
0.0010	102	3.2	5.0	6.8	5.0	0.5	3.2	5.0	6.8	5.0	0.5	3.2	5.0	6.8	5.0	0.5
0.0012	122	3.2	5.0	6.8	5.0	0.5	3.2	5.0	6.8	5.0	0.5	3.2	5.0	6.8	5.0	0.5
0.0015	152	3.2	5.0	6.8	5.0	0.5	3.2	5.0	6.8	5.0	0.5	3.2	5.0	6.8	5.0	0.5
0.0018	182	3.2	5.0	6.8	5.0	0.5	3.2	5.0	6.8	5.0	0.5	3.2	5.0	6.8	5.0	0.5
0.0022	222	3.2	5.0	6.8	5.0	0.5	3.2	5.0	6.8	5.0	0.5	3.2	5.0	6.8	5.0	0.5
0.0027	272	3.2	5.0	6.8	5.0	0.5	3.2	5.0	6.8	5.0	0.5	-	-	-	-	-
0.0033	332	3.2	5.0	6.8	5.0	0.5	3.2	5.0	6.8	5.0	0.5	-	-	-	-	-
0.0039	392	3.2	5.0	6.8	5.0	0.5	3.2	5.0	6.8	5.0	0.5	-	-	-	-	-
0.0047	472	3.2	5.0	6.8	5.0	0.5	3.2	5.0	6.8	5.0	0.5	-	-	-	-	-
0.0056	562	3.2	5.0	6.8	5.0	0.5	3.2	5.0	6.8	5.0	0.5	-	-	-	-	-
0.0068	682	3.2	5.0	6.8	5.0	0.5	3.2	5.0	6.8	5.0	0.5	-	-	-	-	-
0.0082	822	3.2	5.0	6.8	5.0	0.5	3.2	5.0	6.8	5.0	0.5	-	-	-	-	-
0.010	103	3.2	5.0	6.8	5.0	0.5	3.2	5.0	6.8	5.0	0.5	-	-	-	-	-
0.012	123	3.2	5.0	6.8	5.0	0.5	-	-	-	-	-	-	-	-	-	-
0.015	153	3.2	5.0	6.8	5.0	0.5	-	-	-	-	-	-	-	-	-	-
0.018	183	3.2	5.0	6.8	5.0	0.5	-	-	-	-	-	-	-	-	-	-
0.022	223	3.2	5.0	6.8	5.0	0.5	-	-	-	-	-	-	-	-	-	-
0.027	273	3.2	5.0	6.8	5.0	0.5	-	-	-	-	-	-	-	-	-	-
0.033	333	3.2	5.0	6.8	5.0	0.5	-	-	-	-	-	-	-	-	-	-
0.039	393	-	-	-	-	-	-	-	-	-	-	-	-	-	-	-
0.047	473	-	-	-	-	-	-	-	-	-	-	-	-	-	-	-
0.056	563	-	-	-	-	-	-	-	-	-	-	-	-	-	-	-
0.068	683	-	-	-	-	-	-	-	-	-	-	-	-	-	-	-
0.082	823	-	-	-	-	-	-	-	-	-	-	-	-	-	-	-
0.10	104	-	-	-	-	-	-	-	-	-	-	-	-	-	-	-
0.12	124	-	-	-	-	-	-	-	-	-	-	-	-	-	-	-
0.15	154	-	-	-	-	-	-	-	-	-	-	-	-	-	-	-
0.18	184	-	-	-	-	-	-	-	-	-	-	-	-	-	-	-
0.22	224	-	-	-	-	-	-	-	-	-	-	-	-	-	-	-
0.27	274	-	-	-	-	-	-	-	-	-	-	-	-	-	-	-
0.33	334	-	-	-	-	-	-	-	-	-	-	-	-	-	-	-
0.39	394	-	-	-	-	-	-	-	-	-	-	-	-	-	-	-
0.47	474	-	-	-	-	-	-	-	-	-	-	-	-	-	-	-
0.56	564	-	-	-	-	-	-	-	-	-	-	-	-	-	-	-
0.68	684	-	-	-	-	-	-	-	-	-	-	-	-	-	-	-
0.82	824	-	-	-	-	-	-	-	-	-	-	-	-	-	-	-
1.0	105	-	-	-	-	-	-	-	-	-	-	-	-	-	-	-

Sharma Film Capacitors

Taping Specifications For Automatic Insertion

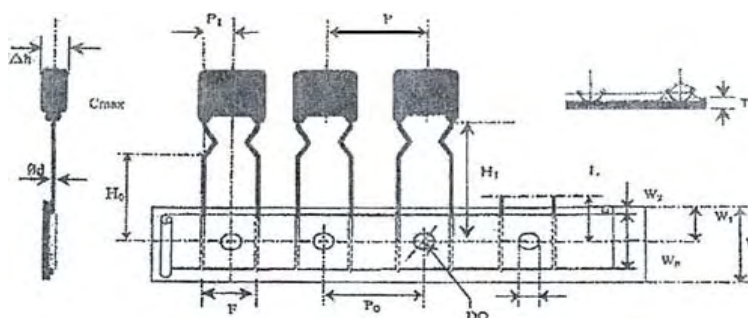

Description	Symbol	Dimensions (mm)	
		Lead Spacing 5mm	Toll
Lead wire diameter	Φd	0.3	±0.05
Taping pitch	P	12.7	±0.1
Sprocket hole pitch	P0	12.7	±0.2
Centering of the lead wire	P1	3.85	±0.5
Centering of the body	P2	6.35	±1.3
Lead spacing	F	5.0	±0.8
Component alignment	Δh	0	±2.0
Height from sprocket hole	H1	20.0	±0.5
Height	H0	16.0	±0.5
Center to the comp body	L	11.0	±0.5
Tape width	W	18.0	+1.0-0.5
Width of adhesive tape	W0	13.0	±0.5
Sprocket hole alignment	W1	9.0	±0.5
Position of adhesive tape	W2	3max	
Sprocket hole diameter	D0	4.0	±0.2
Tape thickness	T	0.7	±0.2

Standard Packing Quantity For Box



50-100V		250V		400V	
102-104 values	2000PCS	102-183 values	2000PCS	102-822 values	2000PCS
124-182 values	1500PCS	223-333 values	1500PCS	103-153 values	1500PCS
224-474 values	1200PCS	393-473 values	1200PCS	183-273 values	1200PCS
564-824 values	1000PCS	563-823 values	1000PCS	333-393 values	1000PCS
105-125 values	800PCS	104-224 values	800PCS	474-563 values	800PCS

Sharma Film Capacitors

MKTD06 SERIES

Features

- Metallized polyester film, epoxy resin coating
- Large C-values in small dimensions
- Excellent self-healing properly and high reliability

Specifications

Operating Temperature	-40+85°C
Rated Voltage	DC 250V, 400V, 630V
Capacitance Range	0.01 to 6.8 Mfd
Capacitance Tolerance	±5%, ±10%
Dissipation Factor	<0.01 (At 1KHz)
Insulation Resistance	Cr≤0.33μF: ≥7,500Mohm, Ur >100V Cr>0.33μF: >25,000Mohm·μF, Ur >100V
Voltage Test	1.4 Ur (Is)

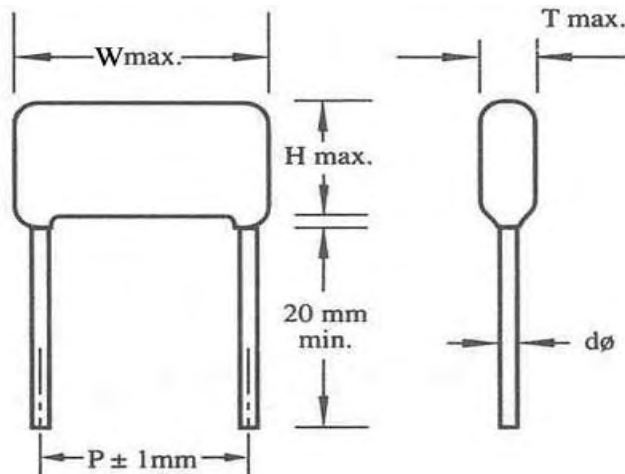

- Special size or items on request.
- Tolerance Dimension ±1.0 mm.

VDC	250VDC				400VDC				630VDC			
	W	T	H	P	W	T	H	P	W	T	H	P
Mfd												
0.01	12	6	8.5	10	11.5	5	8	10.5	12	5	8.5	10
0.015	12	6	8.5	10	11.5	5	8	10.5	12	5	8.5	10
0.018	12	6	8.5	10	11.5	5	8	10.5	12	5	8.5	10
0.022	12	6	9.5	10	12	5	9	10.5	13	6	9.5	10.5
0.027	12	6	9.5	10	12	5	9	10.5	13	6	9.5	10.5
0.033	12	6	9.5	10	12	5	9	10.5	13	6	10	15.5
0.039	12	6	9.5	10	12	5	9	10.5	13	6	10	15.5
0.047	12	6	9.5	10	12	5	9	10.5	17.5	6	10	15.5
0.056	12	6	9.5	10	12.5	5	9	10.5	17.5	6	10	15.5
0.068	12	6	9.5	10	12.5	5	9	10.5	17.5	6	10	15.5
0.082	12	6	9.5	10	12.5	5	9	10.5	17.5	6	10.5	15.5
0.10	12	6	9.5	10	12.5	6	10.5	10.5	17.5	6	11	15.5

Sharma Film Capacitors

0.15	13	6.5	10.5	10.5	17.5	6.5	9.5	15.5	17.5	8	13	15.5
0.18	13	7	10.5	10.5	17.5	5.5	9.5	15.5	17.5	8	13	15.5
0.22	13	7	10.5	10.5	17.5	5.5	9.5	15.5	23	8.5	14.5	20.5
0.27	13	7	10.5	10.5	17.5	5.5	9.5	15.5	23	8.5	14.5	20.5
0.33	17	7	10.5	15	19	7.5	12.5	16.0	23	8.5	14.5	20.5
0.39	17	7	10.5	15	19	7.5	9.5	20.5	23	8.5	14.5	20.5
0.47	17	7	11.5	15	19	7.5	15.5	16.0	23	9	15	20.5
0.50	17	7	11.5	15	22.5	5.5	11.5	20.5	23	9	15	25.5
0.56	18	7	11.5	15	23.5	6	11.5	20.5	23	9	15	25.5
0.68	18	7	13.5	15	23.5	8	12	25.5	28.5	9.5	18	25.5
0.82	18	7.5	13.5	15	23.5	8	12	25.5	28.5	9.5	18	25.5
1.0	23	7.5	13.5	20	23.5	8.5	18.5	20	28.5	10.5	19	25.5
1.2	23	7.5	13.5	20	28	8.5	18	20	28.5	10.5	19	25.5
1.5	23	8	14.5	20	28	9.5	18	25.5	28.5	13.5	22	25.5
1.8	24	8	14.5	20	28	9.5	18	25.5	28.5	13.5	22	25.5
2.2	28	8.5	16	25	30	10	19	28	30.5	13.5	22	28.5
2.5	28	8.5	18	25	30	10.5	19.5	28	30.5	13.5	22	28.5
2.7	28	9	18	25	30	10.5	19.5	28	30.5	13.5	22	28.5
6.8	32	10	18	30	30	10.5	19.5	28	30.5	13.5	22	28.5

*All sizes for reference only *

Sharma Film Capacitors

MKT 00S SERIES

Formerly SMX series

INTRODUCTION

The MKT00S Series Metallized Polyester Film Capacitors are miniature capacitors specially developed for Surface Mount Technology. This series covers a wide range of values and voltages in three convenient case sizes and have excellent electrical characteristics. The MKT00S series has fire retardant epoxy molded encapsulation which also provide high insulation resistance.

FEATURES

- Ultra miniature size
- Wide value and voltage range in just three case sizes
- Flame retardant epoxy encapsulation
- Consistent dimensions and surface finish due to molded construction
- Compatible with all popular high speed assembly machines
- Available in Carrier Tape, Stick and Bulk packing
- Self healing capability
- Compatible with all standard standard SMT soldering methods

GENERAL SPECIFICATIONS:

Dissipation factor: 0.0070 max at 1 K Hz

Insulation resistance: >15,000 M Ohms at a temperature of 25 ± 5 °C, when measured at: 10 ±1 V DC for 63V DC rated capacitors, 100 ±15 V DC for 100 to 400V DC rating and, 500 ±50 V DC for 630V DC rating.

Capacitance tolerance: ±10%(K). ±5%(J) available on request

Voltage Test : 1.5 times the rated voltage applied between terminals for 2 seconds at a temperature of 25 ± 5 °C **Temperature range:** -40 to 105 °C with derating above 85 °C. **Climatic category:** F M E

LIFE TEST DETAILS:

Capacitors shall withstand 125% DC rated voltage or 100% AC rated voltage applied at 85 °C for 1000 hours. After the test:

1. Capacitance change shall remain within ±5%.
2. Dissipation Factor shall be within 1.5 times the original limits.
3. Insulation Resistance shall be above 50% of the initial limits.
4. There shall be no remarkable change in the appearance and the marking shall remain legible.

CASE DIMENSIONS TABLE

CASE SIZE	Dimensions Millimeters (Inches)				
	W	H	L	a	b
G	5.2 (0.205)	3.2 (0.126)	7.2 (0.283)	1.0 (0.039)	3.0 (0.118)
H	8.2 (0.323)	4.5 (0.177)	10.0 (0.394)	1.5 (0.059)	4.0 (0.157)
J	8.2 (0.323)	5.0 (0.197)	12.5 (0.492)	2.0 (0.079)	4.0 (0.157)

TOLERANCE ON DIMENSIONS: ±0.2mm (.008")

DIMENSIONS AND TOLERANCES:

"d" - 0.5 - 0.6 mm (0.020" - 0.024")
for dimension "T" < 3.5mm (0.138")
"d" - 0.6 mm (0.024")
for dimension "T" > 3.5mm (0.138")
"LL" - 4.0 +1.5mm (0.16 + 0.06")
for bulk supply

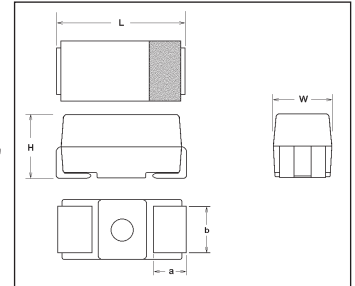

CASE SIZE TABLE

Capacitance in µF	VOLTAGE V DC (Voltage Code)				
	63 (1J)	100 (2A)	250 (2E)	400 (2G)	630 (2J)
0.01		G			H
0.015		G			H
0.022		G		H	J
0.033		G	H	J	
0.047		G	H	J	
0.068	G	H	J		
0.1	G	H	J		
0.15	H	J			
0.22	H	J			

PULSE RISE TIME (dv/dt) - Volts per µSecond.

Rated Voltage	Capacitance Range µF	dv/dt Value
50	0.001-1.0	4
63	0.001-1.0	8
100	>0.0068	10
100	0.0033-0.0068	15
100	>0.0033	30
250	0.001-1.0	20
400	0.001-1.0	40

Ordering Information

Example at right indicates:
MKT 00S Series, 400 V DC, 0.047 µF,
10%, Stick Magazine packing

(EXAMPLE) **M** **K** **T** **0** **0** **S** **2** **G** **4** **7** **3** **K** **S**

Series

Series Code: MKT 00S

Voltage Code

Voltage Code	1J	2A	2E	2G	2J
DC Voltage	63V	100V	250V	400V	630V

Capacitance

First Two Digits Represent Significant Figures of Capacitance in Picofarads.
Third Digit Indicates Number of Zeros

Tolerance

Capacitance Tolerance Code:

Capacitance Tolerance	± 20%	± 10%	± 5%
Code	M	K	J

Packing Method Code

Packing Code	O	T	S
Method	Bulk	Tape	Stick

Case Sizes G, H, J G H, J

Sharma Film Capacitors

MKT 00S Packaging Specification

TAPE DIMENSIONS

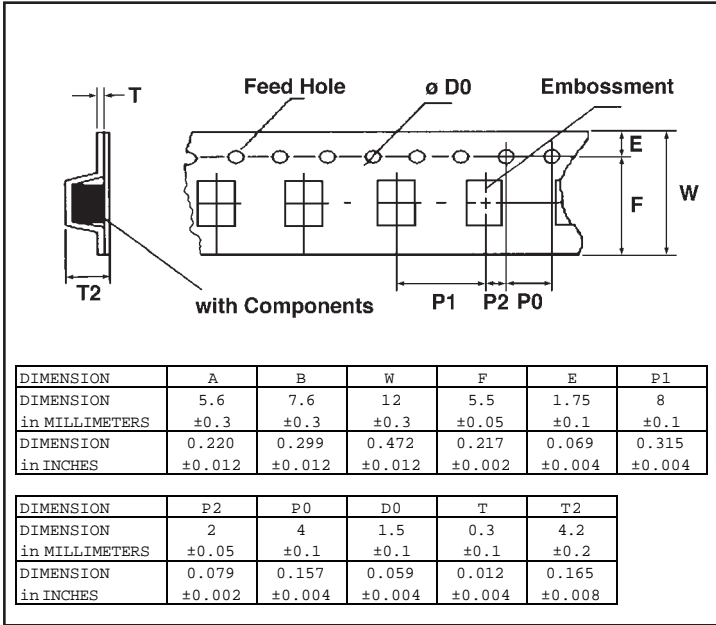

LEADER SPECIFICATIONS

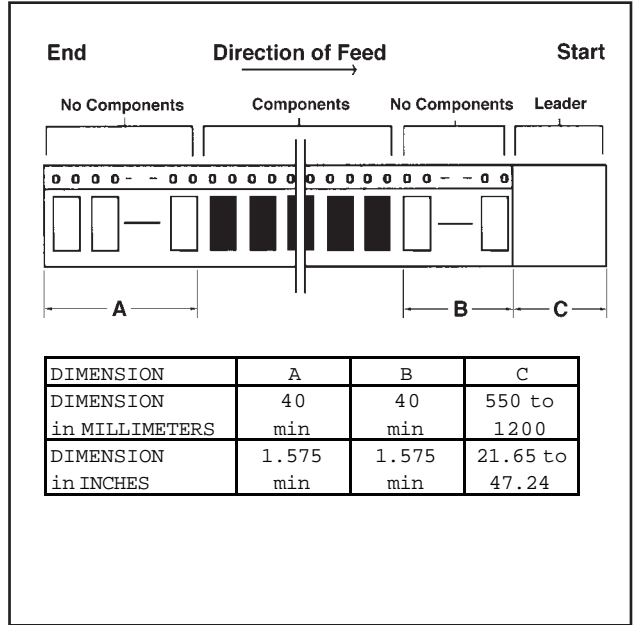

PEEL-OFF

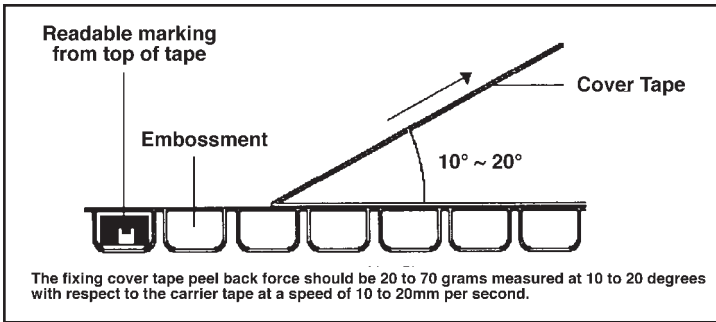

REEL DIMENSIONS (500 pcs/Reel)

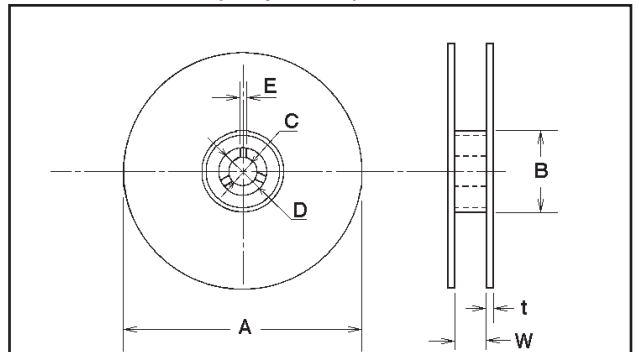

Dimensions in Millimeters

A	B	C	D	E	W	t
ø178 ±2.0	ø50 min.	13.0 ±0.5	21.0 ±0.8	2.0 ±0.8	8.8/12.8 ±1.5	2.0 ±0.5
ø330 ±2.0	ø100 min.	13.0 ±0.5	21.0 ±0.8	2.0 ±0.8	8.8/12.8 ±1.5	2.0 ±0.6

Dimensions in Inches

A	B	C	D	E	W	t
ø7 ±0.08	ø2.0 min.	5.0 ±0.02	0.83 ±0.03	0.08 ±0.3	0.35/0.50 ±0.06	0.08 ±0.02
ø13 ±0.08	ø4.0 min.	5.0 ±0.3	0.83 ±0.03	0.08 ±0.3	0.35/0.50 ±0.06	0.08 ±0.02

STICK MAGAZINE DIMENSIONS

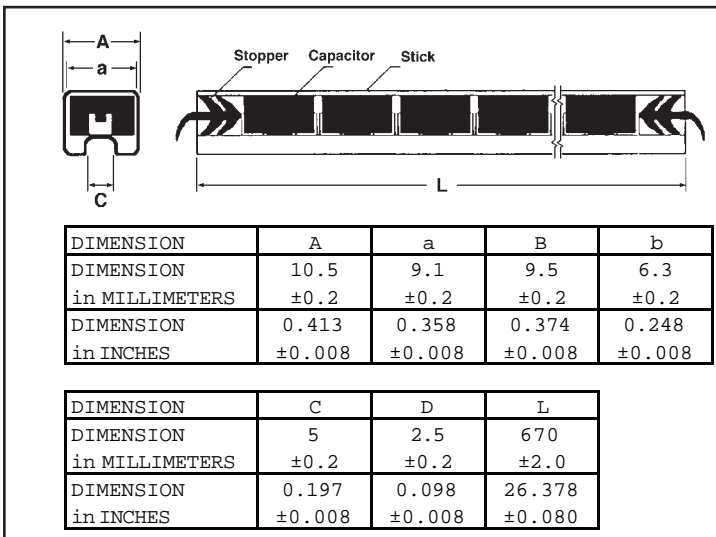

STANDARD PACKING QUANTITY

CASE SIZE	QUANTITY PER PACK		
	TAPE	STICK	BULK
G	500	NA	100
H	NA	60	100
J	NA	50	100

Sharma Film Capacitors

MKTR SERIES

Formerly MPR series

INTRODUCTION

The MKTR Series Round Axial Metallized Polyester Film Capacitors cover a wide range of values and voltages. These capacitors also have good high frequency characteristics and are suitable for applications such as Blocking, By-passing, Coupling and all General Purpose applications.

FEATURES

- Wide value and Voltage range
- Tape wrapped axial construction for different typed of mounting
- Reduced dimensions due to taped wrapped encapsulation
- Self healing capability
- Available in tape and reel form for automatic insertion (please check with us about availability of specific values)
- Close tolerance $\pm 1\%$ and $\pm 2\%$ available on request

GENERAL SPECIFICATIONS

Dissipation factor: ≤ 0.0100 at 1 K Hz

Insulation resistance: For 100 VDC rated parts; $\geq 9,000$ M Ohms for $C \leq 0.33 \mu\text{F}$,

$\geq 3,000$ seconds for $C > 0.33 \mu\text{F}$ at a temperature of $25 \pm 5^\circ\text{C}$.

For 250 to 630 VDC rated parts; $\geq 15,000$ M Ohms for $C \leq 0.33 \mu\text{F}$, $\geq 5,000$ seconds for $C > 0.33 \mu\text{F}$ at a temperature of $25 \pm 5^\circ\text{C}$.

Capacitance tolerance: $\pm 5\%$ (J), $\pm 10\%$ (K) and $\pm 20\%$ (M).

Voltage Test : 1.6 times the rated voltage applied between terminals for 2 seconds. at a temperature of $25 \pm 5^\circ\text{C}$.

Temperature range: -40 to 85°C with derating above 85°C .

Climatic category: G P D

LIFE TEST DETAILS:

Capacitors shall withstand 125% DC rated voltage or 100% AC rated voltage applied at 85°C for 1000 hours. After the test;

1. Capacitance change shall remain within $\pm 5\%$.
2. Dissipation Factor shall be within 1.5 times the original limits
3. Insulation Resistance shall be above 30% of the initial limits.
4. There shall be no remarkable change in the appearance and the marking shall remain legible.

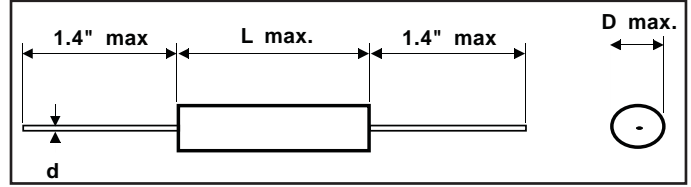

DIMENSIONS AND TOLERANCES

"d" = 0.6 mm (0.024") For $D \leq 6.0$ mm

"d" = 0.8 mm (0.032") For $D > 6.0$ mm

PULSE RISE TIME (dv/dt) Volts per μsec .

RATED VOLTAGE	dv / dt rating in volts / μ seconds
100	1
160	2
250	3
400	5
630	7
1000	10

Case Dimensions in Millimeters: 100V • 160V • 250V • 400V • 630V

VOLTAGE DC	100		160		250		400		630	
VOLTAGE AC	63		90		160		200		220	
Capacitance in μF	Dimensions in MM		Dimensions in MM		Dimensions in MM		Dimensions in MM		Dimensions in MM	
	D	L	D	L	D	L	D	L	D	L
0.01	5	10.5	5	10.5	5	10.5	5	10.5	6	14
0.015	5	10.5	5	10.5	5	10.5	5.5	14	6.5	14
0.022	5	10.5	5	10.5	5	10.5	5.5	14	7	14
0.033	5	10.5	5	10.5	5	10.5	6	14	7	19
0.047	5.5	10.5	5.5	10.5	5.5	14	7	14	7.5	19
0.068	5.5	10.5	5.5	10.5	5.5	14	7	19	8.5	19
0.1	5.5	10.5	6	10.5	6	14	7.5	19	9	27
0.15	5.5	14	6	14	7	19	8.5	19	10.5	27
0.22	5.5	14	6.5	14	7	19	8.5	27	11.5	27
0.33	5.5	14	7.5	14	8	19	10	27	11.5	32
0.47	6.5	14	7.5	19	9.5	27	12.5	27	14	32
0.68	6.5	19	8	19	9.5	27	12.5	32	16.5	32
1.0	7.5	19	9.5	19	10.5	27	14.5	32	20	32
1.5	9.5	19	9.5	27	12.5	27	17.5	32	19	47
2.2	9.5	27	11	27	14	32	20.5	32	23	47
3.3	11	27	13	27	16	32	20.5	47	28	47
4.7	12.5	27	14	32	18.5	32	23	47		
6.8	14	32	17	32	21.5	47	27	47		

Case Dimensions in Inches: 100V • 160V • 250V • 400V • 630V

VOLTAGE DC	100		160		250		400		630	
VOLTAGE AC	63		90		160		200		220	
Capacitance in μF	Dimensions in Inches		Dimensions in Inches		Dimensions in Inches		Dimensions in Inches		Dimensions in Inches	
	D	L	D	L	D	L	D	L	D	L
0.01	0.197	0.413	0.197	0.413	0.197	0.413	0.197	0.413	0.236	0.551
0.015	0.197	0.413	0.197	0.413	0.197	0.413	0.217	0.551	0.256	0.551
0.022	0.197	0.413	0.197	0.413	0.197	0.413	0.217	0.551	0.276	0.551
0.033	0.197	0.413	0.197	0.413	0.197	0.413	0.236	0.551	0.276	0.748
0.047	0.217	0.413	0.217	0.413	0.217	0.551	0.276	0.551	0.295	0.748
0.068	0.217	0.413	0.217	0.413	0.217	0.551	0.276	0.748	0.335	0.748
0.1	0.217	0.413	0.236	0.413	0.236	0.551	0.295	0.748	0.354	1.063
0.15	0.217	0.551	0.236	0.551	0.276	0.748	0.335	0.748	0.413	1.063
0.22	0.217	0.551	0.256	0.551	0.276	0.748	0.335	1.063	0.453	1.063
0.33	0.217	0.551	0.295	0.551	0.315	0.748	0.394	1.063	0.453	1.260
0.47	0.256	0.551	0.295	0.748	0.374	1.063	0.492	1.063	0.551	1.260
0.68	0.256	0.748	0.315	0.748	0.374	1.063	0.492	1.260	0.650	1.260
1.0	0.295	0.748	0.374	0.748	0.413	1.063	0.571	1.260	0.787	1.260
1.5	0.374	0.748	0.374	1.063	0.492	1.063	0.689	1.260	0.748	1.850
2.2	0.374	1.063	0.433	1.063	0.551	1.260	0.807	1.260	0.906	1.850
3.3	0.433	1.063	0.512	1.063	0.630	1.260	0.807	1.850	1.102	1.850
4.7	0.492	1.063	0.551	1.260	0.728	1.260	0.906	1.850		
6.8	0.551	1.260	0.669	1.260	0.846	1.850	1.063	1.850		

Sharma Film Capacitors

MKTO SERIES

Formerly MPO series

INTRODUCTION

The MKTO Series Flat Axial Metallized Polyester Film Capacitors cover a wide range of values and voltages. These capacitors also have good high frequency characteristics and are suitable for; Blocking, By-passing, Coupling and all General Purpose applications. This series is specifically designed for mounting in locations where height is critical or where different mounting options are required.

FEATURES:

- Wide value and Voltage range
- Flat axial construction for different types of mounting
- Reduced dimensions due to tape wrapped encapsulation
- Self healing capability

GENERAL SPECIFICATIONS

Dissipation factor: ≤ 0.0100 at 1 K Hz. **Insulation resistance:** For 100 VDC rated parts; $\geq 9,000$ M Ohms for $C \leq 0.33 \mu\text{F}$, $\geq 3,000$ seconds for $C > 0.33 \mu\text{F}$

at a temperature of $25 \pm 5^\circ\text{C}$. For 250 to 630 VDC rated parts; $\geq 15,000$ M Ohms for $C \leq 0.33 \mu\text{F}$, $\geq 5,000$ seconds for $C > 0.33 \mu\text{F}$ at a temperature of $25 \pm 5^\circ\text{C}$. **Capacitance tolerance:** $\pm 5\%$ (J), $\pm 10\%$ (K) and $\pm 20\%$ (M) Voltage Test: 1.6 times the rated voltage applied between terminals for 2 seconds. at a temperature of $25 \pm 5^\circ\text{C}$

Temperature range: -40 to 85°C with derating above 85°C .

Climatic category: G P D

LIFE TEST DETAILS:

Capacitors shall withstand 125% DC rated voltage or 100% AC rated voltage applied at 85°C for 1000 hours. After the test;

1. Capacitance change shall remain within $\pm 5\%$.
2. Dissipation Factor shall be within 1.5 times the original limits
3. Insulation Resistance shall be above 50% of the initial limits.
4. There shall be no remarkable change in the appearance and the marking shall remain legible.

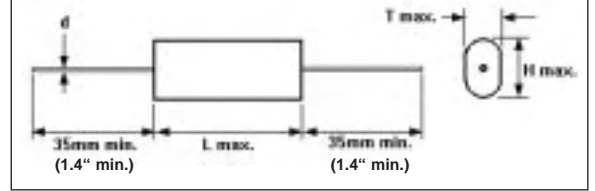

DIMENSIONS AND TOLERANCES

"d" - 0.8 mm (0.032")

PULSE RISE TIME (dv/dt) Volts per μsec .

RATED VOLTAGE	dv / dt rating in volts / μ seconds
100	1
160	2
250	3
400	5
630	7
1000	10

Case Dimensions in Millimeters: 100V • 250V • 400V • 630V

VOLTAGE (DC)	100 V DC			250 V DC			400 V DC			630 V DC		
	63 V AC			160 V AC			200 V AC			220 V AC		
VOLTAGE (AC)	Dimensions in Millimeters			Dimensions in Millimeters			Dimensions in Millimeters			Dimensions in Millimeters		
Capacitance in μF	L	H	T	L	H	T	L	H	T	L	H	T
0.01										14.0	7.0	4.5
0.015										14.0	7.5	5.0
0.022										14.0	8.0	6.0
0.033										19.0	10.0	5.0
0.047										19.0	10.0	5.0
0.068										19.0	11.0	6.0
0.1	14.0	8.0	4.5	14.0	8.0	4.5	19.0	10.0	5.0	27.0	10.5	6.0
0.15	14.0	8.0	4.5	14.0	9.0	5.0	19.0	11.0	6.5	27.0	13.0	7.5
0.22	14.0	8.5	5.0	19.0	9.0	5.0	19.0	13.0	8.0	27.0	14.5	8.5
0.33	19.0	8.0	4.5	19.0	10.5	5.5	27.0	13.0	7.0	32.0	15.0	9.5
0.47	19.0	9.0	5.0	19.0	12.0	7.0	27.0	14.0	8.0	32.0	17.0	12.0
0.68	19.0	10.5	5.5	27.0	12.0	6.0	32.0	16.0	9.0	32.0	20.0	15.0
1	19.0	12.0	6.0	27.0	13.0	7.0	32.0	18.5	10.5	32.0	26.0	17.0
1.5	19.0	14.0	8.5	32.0	15.0	8.5	32.0	22.0	12.0	47.0	23.5	16.5
2.2	27.0	14.0	7.0	32.0	16.5	10.0	32.0	24.0	16.0	47.0	25.5	17.5
3.3	27.0	17.0	9.5	32.0	20.5	12.0	47.0	23.5	15.0	47.0	34.0	21.0
4.7	32.0	18.0	10.0	32.0	25.0	14.0	47.0	27.0	18.0			
6.8	32.0	21.0	11.0	47.0	23.0	14.0	47.0	34.0	22.0			

Case Dimensions in Inches: 100V • 250V • 400V • 630V

VOLTAGE (DC)	100 V DC			250 V DC			400 V DC			630 V DC		
	63 V AC			160 V AC			200 V AC			220 V AC		
VOLTAGE (AC)	Dimensions in Inches			Dimensions in Inches			Dimensions in Inches			Dimensions in Inches		
Capacitance in μF	L	H	T	L	H	T	L	H	T	L	H	T
0.01										0.551	0.276	0.177
0.015										0.551	0.295	0.197
0.022										0.551	0.315	0.236
0.033										0.748	0.394	0.197
0.047										0.748	0.394	0.197
0.068										0.748	0.433	0.236
0.1	0.551	0.315	0.177	0.551	0.315	0.177	0.748	0.394	0.197	1.063	0.413	0.236
0.15	0.551	0.315	0.177	0.551	0.354	0.197	0.748	0.433	0.256	1.063	0.512	0.295
0.22	0.551	0.335	0.197	0.748	0.354	0.197	0.748	0.512	0.315	1.063	0.571	0.335
0.33	0.748	0.315	0.177	0.748	0.413	0.217	1.063	0.512	0.276	1.260	0.591	0.374
0.47	0.748	0.354	0.197	0.748	0.472	0.276	1.063	0.551	0.315	1.260	0.669	0.472
0.68	0.748	0.413	0.217	1.063	0.472	0.236	1.260	0.630	0.354	1.260	0.787	0.591
1	0.748	0.472	0.236	1.063	0.512	0.276	1.260	0.728	0.413	1.260	1.024	0.669
1.5	0.748	0.551	0.335	1.260	0.591	0.335	1.260	0.866	0.472	1.850	0.925	0.650
2.2	1.063	0.551	0.276	1.260	0.650	0.394	1.260	0.945	0.630	1.850	1.004	0.689
3.3	1.063	0.669	0.374	1.260	0.807	0.472	1.850	0.925	0.591	1.850	1.339	0.827
4.7	1.260	0.709	0.394	1.260	0.984	0.551	1.850	1.063	0.709			
6.8	1.260	0.827	0.433	1.850	0.906	0.551	1.850	1.339	0.866			

Sharma Film Capacitors

MKT FS SERIES

INTRODUCTION:

The MKTFS Series Metallized Polyester Film Capacitors cover a wide range of values and voltages. This series provides alternative dimensions for the same values covered by the other MKTD series. These capacitors are suitable for applications such as Blocking, By-passing and Coupling and are widely used in General communication equipment.

FEATURES:

- Wide value and Voltage range
- Self healing capability
- Flame retardant powder epoxy encapsulation
- Minimum overall dimensions due to dip coated construction

GENERAL SPECIFICATIONS:

Dissipation factor: < 0.0100 at 1 K Hz for capacitance ≤ 1.0 μF, < 0.0150 at 1 K Hz for capacitance > 1.0 μF. **Insulation resistance:** For 100 VDC rated parts; ≥ 9,000 M Ohms for C ≤ 0.33 μF, ≥ 3,000 seconds for C > 0.33 μF at a temperature of 25 ± 5 °C. For 250 to 630 VDC rated parts; ≥ 15,000 M Ohms for C ≤ 0.33 μF, ≥ 5,000 seconds for C > 0.33 μF at a temperature of 25 ± 5 °C. **Capacitance tolerance:** ±5%(J) and ±10%(K). **Voltage Test :** 1.75 times the rated voltage applied between terminals for 5 seconds. at a temperature of 25 ± 5 °C. **Temperature range:** -40 to 85 °C.

LIFE TEST DETAILS:

Capacitors shall withstand 125% DC rated voltage or 100% AC rated voltage applied at 85 °C for 1000 hours. After the test:

1. Capacitance change shall remain within ±5%.
2. Dissipation Factor shall be within 1.5 times the original limits.
3. Insulation Resistance shall be above 50% of the initial limits.
4. There shall be no remarkable change in the appearance and the marking shall remain legible.

DIMENSIONS AND TOLERANCES:

d - 0.7 mm

z - 3 mm max.

LL - 20.0 mm min.

Tolerance on P ±1.5 mm

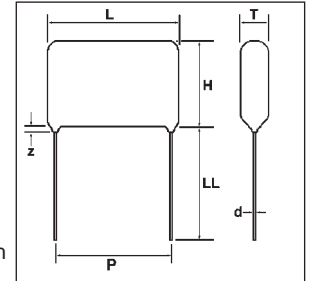

PULSE RISE TIME (dv/dt) Volts per μsec.

Rated Voltage	LEAD SPACING mm (inches)			
	10.0 (0.40)	15.0 (0.60)	22.5 (0.89)	27.0 (1.06)
100	6	3	2	1
250	11	7	4	3
400	20	10	5.5	5
630	30	15	8	7

Case Dimensions in Millimeters 100V • 250V

Capacitance in μF	VOLTAGE DC/AC							
	100 V DC / 63 V AC				250 V DC / 160 V AC			
	Dimensions in Millimeters							
	L	H	T	P	L	H	T	P
0.01	13.0	9.5	5.0	11.5	13.0	9.5	5.0	11.5
0.015	13.0	9.5	5.0	11.5	13.0	9.5	5.0	11.5
0.022	13.0	9.5	5.0	11.5	13.0	9.5	5.0	11.5
0.033	13.0	9.5	5.0	11.5	13.0	9.5	5.0	11.5
0.047	13.0	10.0	5.5	11.5	13.0	10.0	5.5	11.5
0.056	13.0	10.0	5.5	11.5	13.0	10.0	5.5	11.5
0.068	13.0	10.0	5.0	11.5	13.0	10.0	5.0	11.5
0.082	13.0	10.0	5.5	11.5	13.0	10.0	5.5	11.5
0.1	13.0	9.5	5.0	11.5	13.0	9.5	5.0	11.5
0.15	13.0	1.5	5.5	11.5	13.0	10.5	5.5	11.5
0.22	13.0	11.0	5.5	11.5	13.0	11.0	6.0	11.5
0.33	13.0	11.0	6.0	11.5	13.0	11.5	6.0	11.5
0.47	13.0	11.0	6.0	11.5	18.5	12.5	6.0	15.0
0.56	18.5	11.0	5.5	16.0	18.5	13.0	6.5	15.5
0.68	18.5	12.0	6.0	16.0	18.5	13.5	7.0	15.5
1.0	18.5	13.5	7.5	16.0	24.0	13.0	6.0	21.0
1.5	18.5	15.5	8.5	16.0	24.0	16.5	8.5	21.5
2.2	24.0	16.0	9.0	21.5	30.0	17.0	9.0	27.0
3.3	30.0	19.0	12.0	21.5	30.0	21.0	12.0	27.5
4.7	30.0	20.0	12.0	26.5	30.0	24.0	15.0	27.5
10	37.0	25.0	18.0	32.5				

Case Dimensions in Millimeters 400V • 630V

Capacitance in μF	VOLTAGE DC/AC							
	400 V DC / 200 V AC				630 V DC / 220 V AC			
	Dimensions in Millimeters							
	L	H	T	P	L	H	T	P
0.01	13.0	9.5	5.0	11.5	13.0	10.0	5.5	11.5
0.015	13.0	9.5	5.0	11.5	13.0	10.0	5.5	11.5
0.022	13.0	9.5	5.0	11.5	13.0	11.0	5.5	11.5
0.033	13.0	9.5	5.0	11.5	13.0	11.5	6.0	11.5
0.047	13.0	10.0	5.5	11.5	18.0	11.5	6.0	16.5
0.056	15.0	10.0	5.5	13.0	18.0	12.0	6.5	16.5
0.068	15.0	10.5	5.5	13.0	18.0	12.5	6.5	16.5
0.082	15.0	11.0	5.5	13.0	18.0	13.0	7.0	16.5
0.1	15.0	12.0	6.0	13.0	18.0	13.5	7.0	16.5
0.15	15.0	12.5	6.5	13.0	18.0	14.5	8.0	16.5
0.22	18.5	12.0	5.0	16.5	24.0	13.0	6.0	21.5
0.33	18.5	13.0	7.0	16.5	24.0	15.5	7.5	21.5
0.47	24.0	13.0	5.5	21.5	24.0	16.5	8.0	21.5
0.56	24.0	13.5	6.5	21.5	24.0	17.5	9.0	21.5
0.68	24.0	14.0	7.0	21.5	24.0	18.5	10.0	21.5
1.0	24.0	18.0	9.0	21.5	31.0	21.0	11.0	27.5
1.5	24.0	20.0	10.0	21.5				

MKTMPX SERIES SAFETY RECOGNIZED FILM CAPACITOR

1. Rated Interference Suppression "X2" Metallized Polypropylene Composite dielectric.
UL 1414 (250V AC), CUL 1414/Canda (250V VAC)
VDE KEMA SEV NEMKO DEMKO SEMKO FIMKO CHINA:
DIN EN 132400 (1994) / IEC60382-14 (1993) AND IEC DRAFT 40 (SEC)677
2. Ideal for using in Line-By-Pass, Antenna Coupling, Across-The-Line and Spark killer circuits and available for EMI filter and switching power supply and radio-and monitor, television application.
3. Flame retardant plastic cases and epoxy resin. (compliance with 94V-0)
4. Self-healing properties.
5. Proven series wound construction.
6. Approved By : UL, CSA, VDE, KEMA, SEV, NEMKO, DEMKO, SEMKO, FIMKO, CHINA.

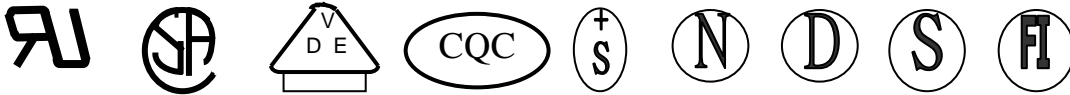

SPECIFICATIONS :

OPERATING TEMPERATURE	-40 °C to +100 °C
RATED VOLTAGE	280VAC
CAPACITANCE RANGE	0.0022 ~ 4.7uF
DIELECTRIC STRENGTH	Applied 1500VDC for 1minute or 2100VDC for 1 second.
CAPACITANCE TOLERANCE	+/-10% (K)
INSULATION RESISTANCE	Measured after a charging voltage 100 ±15VDC for 1 minute. (1) LESS THAN OR EQUAL TO 0.33μF ≥ 30,000MΩ (2) GREATER THAN 0.33μF ≥ 10,000MΩ · μF
DISSIPATION FACTOR	0.1% MAX. at 1KHz
MAXIMUM PULSE RISE TIME	250 VAC: 120 V/microsecond.

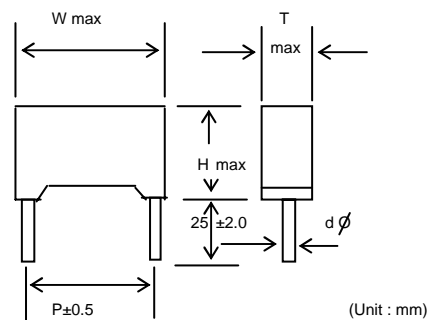

μF \ SIZE	W	H	T	P	d φ	μF \ SIZE	W	H	T	P	d φ
0.0022	13.0	9.0	4.0	10.0	0.6	0.22	26.5	16.5	7.0	22.5	0.8
0.0027	13.0	9.0	4.0	10.0	0.6	0.27	26.5	16.5	8.5	22.5	0.8
0.0033	13.0	9.0	4.0	10.0	0.6	0.33	18.0	14.5	8.5	15.0	0.8
0.0039	13.0	9.0	4.0	10.0	0.6	0.33	26.5	16.5	7.0	22.5	0.8
0.0047	13.0	12.0	5.0	10.0	0.6	0.33	26.5	17.0	8.5	22.5	0.8
0.0056	13.0	12.0	5.0	10.0	0.6	0.39	26.5	20.0	10.0	22.5	0.8
0.0068	13.0	12.0	5.0	10.0	0.6	0.47	17.5	19.0	11.0	15.0	0.8
0.0082	13.0	12.0	5.0	10.0	0.6	0.47	18.0	16.0	10.0	15.0	0.8
0.01	13.0	12.0	5.0	10.0	0.6	0.47	26.5	17.0	8.5	22.5	0.8
0.012	13.0	12.0	5.0	10.0	0.6	0.47	26.5	20.0	10.0	22.5	0.8
0.015	13.0	12.0	5.0	10.0	0.6	0.47	32.0	20.0	11.0	27.5	0.8
0.018	13.0	12.0	5.0	10.0	0.6	0.56	32.0	20.0	11.0	27.5	0.8
0.022	13.0	12.0	5.0	10.0	0.6	0.68	26.5	20.0	10.0	22.5	0.8
0.027	13.0	12.0	5.0	10.0	0.6	0.68	32.0	20.0	11.0	27.5	0.8
0.033	13.0	12.0	5.0	10.0	0.6	0.82	32.0	22.0	13.0	27.5	0.8
0.039	13.0	12.0	6.0	10.0	0.6	0.82	26.5	20.0	10.0	22.5	0.8
0.047	18.0	11.0	5.0	15.0	0.6	1.0	32.0	20.0	11.0	27.5	0.8
0.047	13.0	12.0	6.0	10.0	0.6	1.0	32.0	22.0	13.0	27.5	0.8
0.056	13.0	12.0	6.0	10.0	0.6	1.0	37.0	25.0	13.5	31.5	0.8
0.068	13.0	12.0	6.0	10.0	0.6	1.5	32.0	22.0	13.0	27.5	0.8
0.068	18.0	11.0	5.0	15.0	0.6	1.5	37.0	26.5	17.0	31.5	0.8
0.082	18.0	12.0	5.5	15.0	0.8	1.8	37.0	29.0	19.0	31.5	0.8
0.1	13.5	12.0	6.0	10.0	0.8	2.0	31.0	31.0	22.0	27.5	0.8
0.1	18.0	12.0	6.0	15.0	0.8	2.0	38.0	28.0	18.0	31.5	0.8
0.1	18.0	11.5	5.5	15.0	0.8	2.2	31.0	31.0	22.0	27.5	0.8
0.12	18.0	13.0	6.5	15.0	0.8	2.2	38.0	29.0	19.0	31.5	0.8
0.15	18.0	13.5	7.5	15.0	0.8	2.5	38.0	30.0	20.0	31.5	0.8
0.15	26.5	15.0	6.0	22.5	0.8	3.0	38.0	30.0	20.0	31.5	0.8
0.18	18.0	14.5	8.5	15.0	0.8	3.3	38.8	31.3	21.7	31.5	0.8
0.18	26.5	16.0	6.0	22.5	0.8	4.0	48.0	30.0	30.0	41.5	0.8
0.22	18.0	14.5	8.5	15.0	0.8	4.7	48.0	30.0	30.0	41.5	0.8D

Dimension Tolerance: +/- 0.5mm