

Descriptions

- General purpose amplifier
- High current application

Features

- High h_{FE} : $h_{FE}=160\sim 320$
- Low collector saturation voltage
: $V_{CE(sat)}=0.5V(MAX.)$

PIN Connection

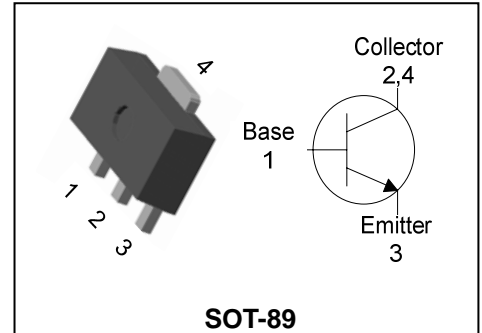

Ordering Information

Type No.	Marking	Package Code
STC201F	C201 YWW	SOT-89

C201: DEVICE CODE, YWW(Y : Year code, WW : Weekly code)

Absolute maximum ratings

($T_a=25^\circ C$)

Characteristic	Symbol	Ratings	Unit
Collector-Base voltage	V_{CBO}	45	V
Collector-Emitter voltage	V_{CEO}	40	V
Emitter-Base voltage	V_{EBO}	5	V
Collector current	I_C	1	A(DC)
	I_{CP}^*	2	A(Pulse)
Collector power dissipation	P_C	0.5	W
	P_C^{**}	1	
Junction temperature	T_J	150	$^\circ C$
Storage temperature	T_{stg}	-55~150	$^\circ C$

* : Single pulse, $t_p=300\ \mu s$

** : When mounted on ceramic substrate($250\ mm^2 \times 0.8t$)

Electrical Characteristics

(Ta=25°C)

Characteristic	Symbol	Test Condition	Min.	Typ.	Max.	Unit
Collector-Base breakdown voltage	BV_{CBO}	$I_C=100\mu A, I_E=0$	45	-	-	V
Collector-Emitter breakdown voltage	BV_{CEO}	$I_C=1mA, I_B=0$	40	-	-	V
Emitter-Base breakdown voltage	BV_{EBO}	$I_E=10\mu A, I_C=0$	5	-	-	V
Collector cut-off current	I_{CBO}	$V_{CB}=45V, I_E=0$	-	-	0.1	μA
Emitter cut-off current	I_{EBO}	$V_{EB}=5V, I_C=0$	-	-	0.1	μA
DC current gain	h_{FE}^*	$V_{CE}=1V, I_C=100mA$	160	-	320	-
Collector-Emitter saturation voltage	$V_{CE(sat)}$	$I_C=500mA, I_B=50mA$	-	-	0.5	V
Transition frequency	f_T	$V_{CE}=5V, I_C=10mA$	-	150	-	MHz
Collector output capacitance	C_{ob}	$V_{CB}=10V, I_E=0, f=1MHz$	-	8	-	pF

* Note 1) h_{FE} Rank : 160~320 only* Note 2) Pulse Tester : Pulse Width $\leq 300\mu s$, Duty Cycle $\leq 2.0\%$

Electrical Characteristic Curves

Fig. 1 $P_C - T_a$

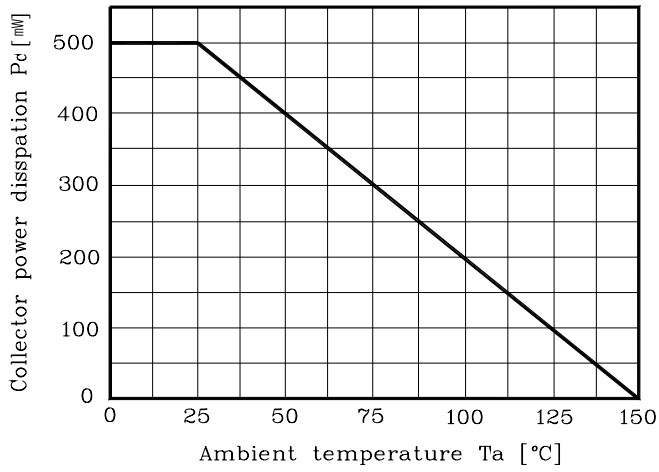

Fig. 2 $I_C - V_{BE}$

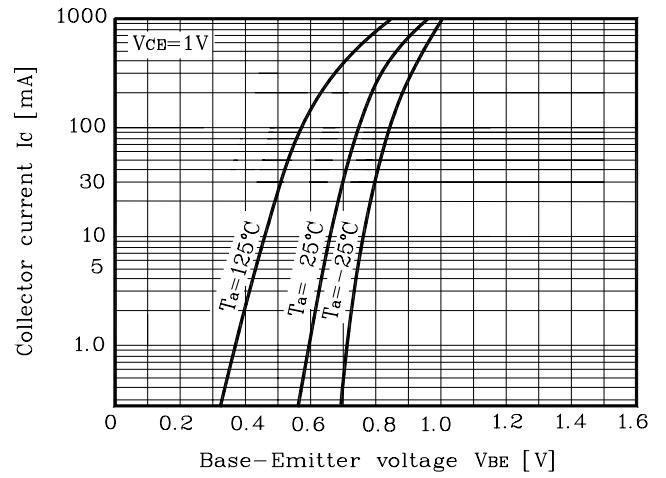

Fig. 3 $V_{CE(sat)} - I_C$

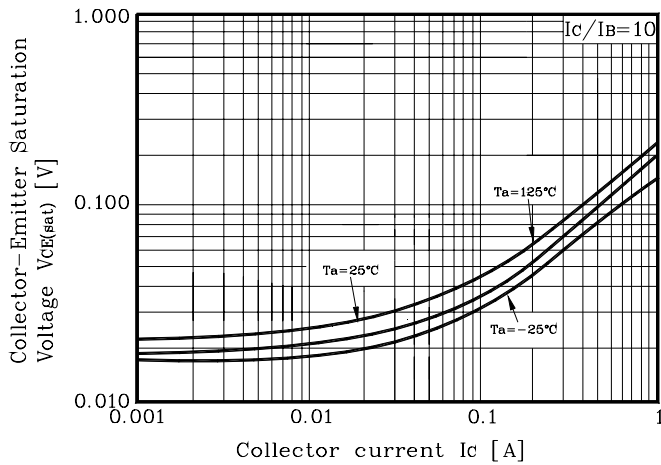

Fig. 4 $I_C - V_{CE}$

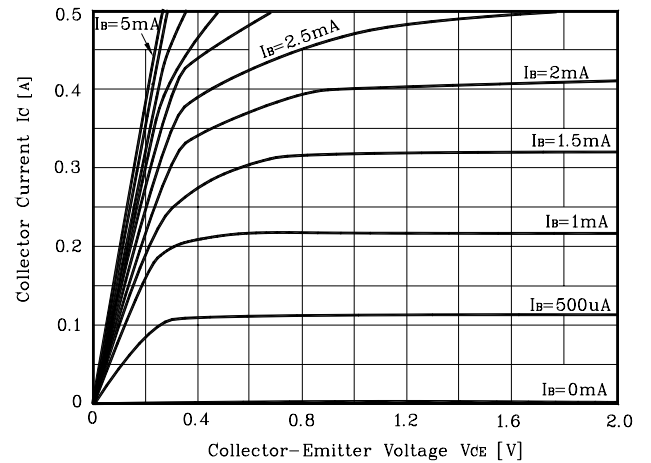

Fig. 5 $I_C - V_{CE}$

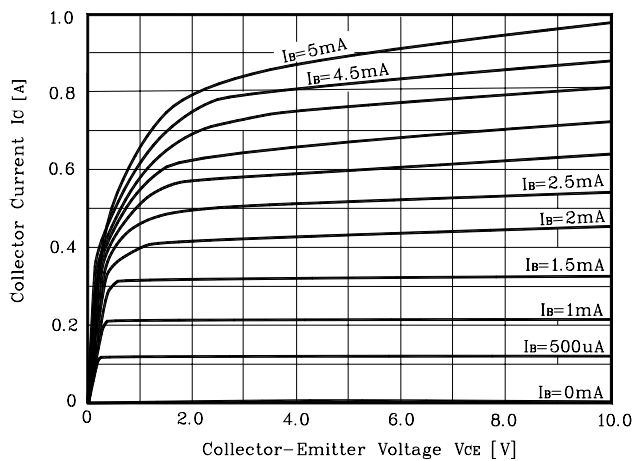

Fig. 6 $h_{FE} - I_C$

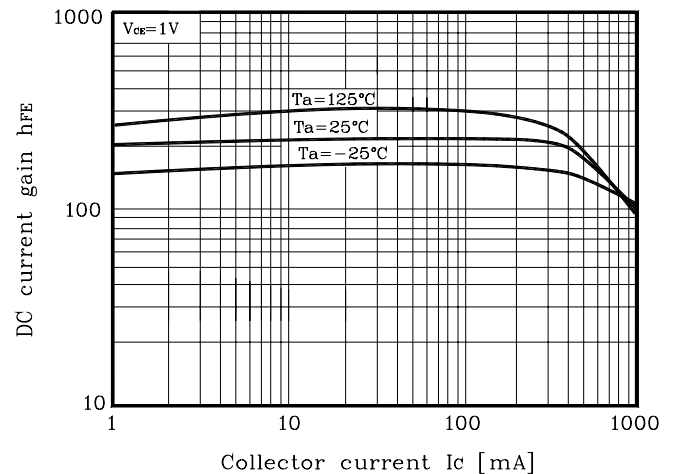

Fig. 7 $h_{FE} - I_C$

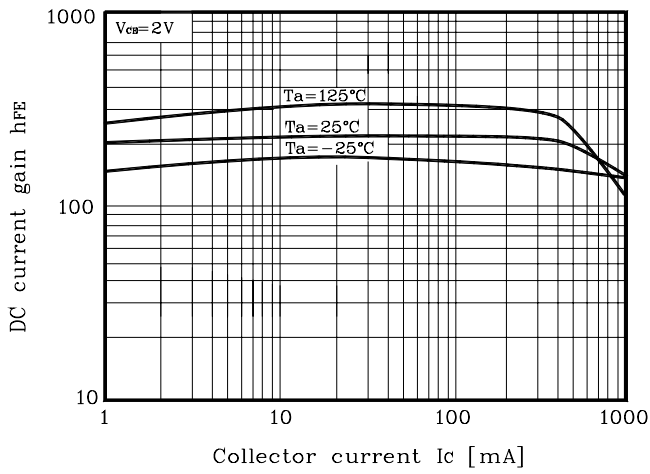

Fig. 8 $h_{FE} - I_C$

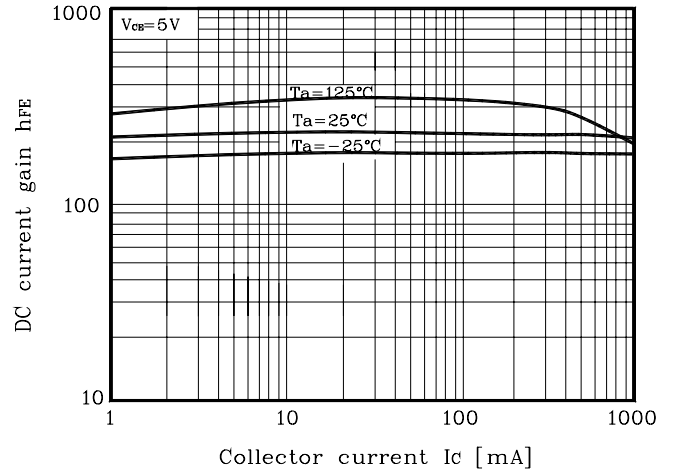

Fig. 9 $C_{ob} - V_{CB}$

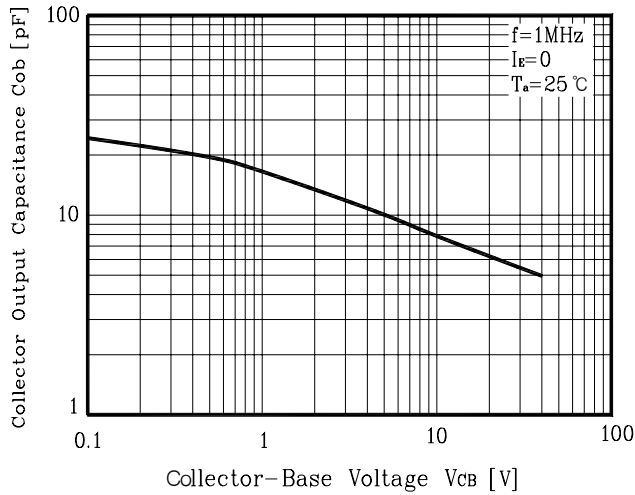

Fig. 10 $f_T - I_C$

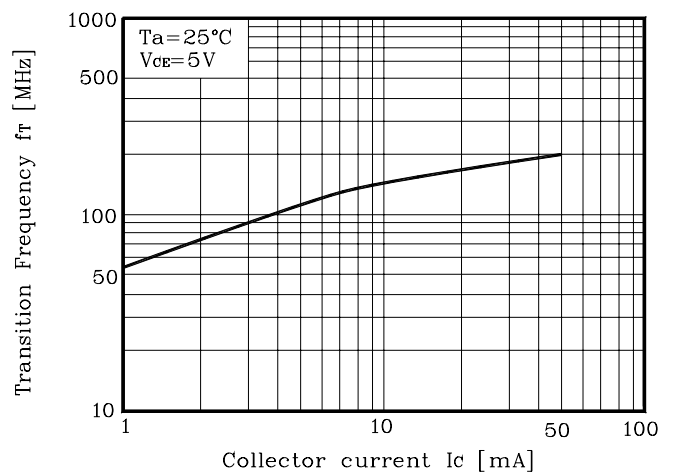
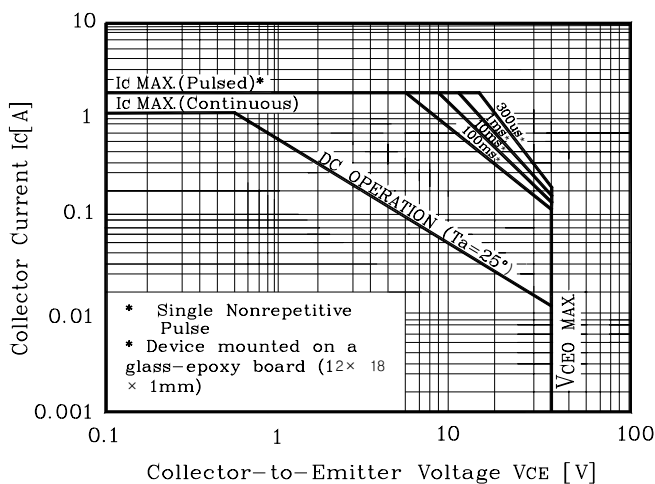
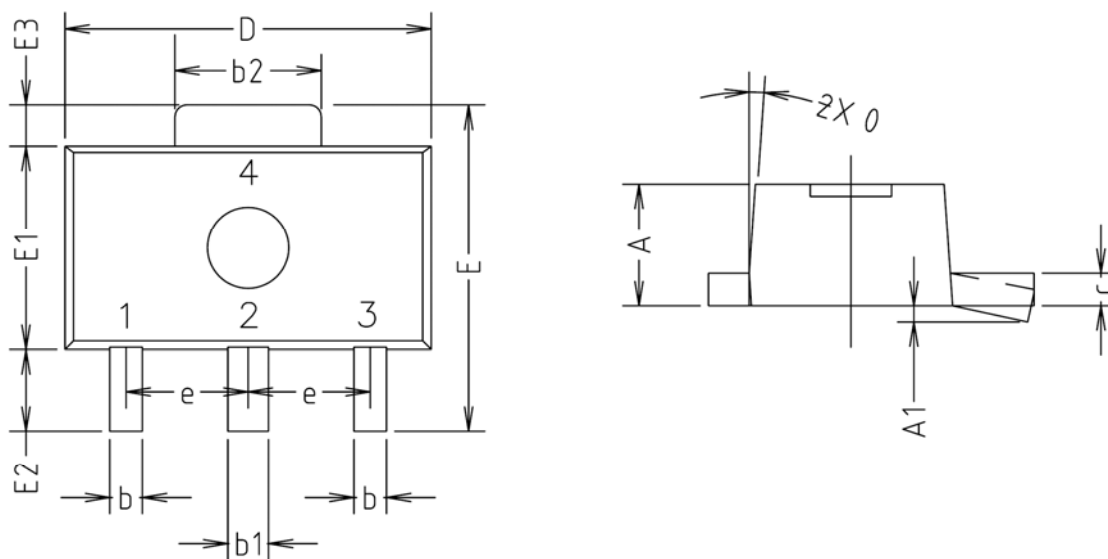

Fig. 11 Safe operating Area



Outline Dimension(mm)



SYMBOL	MILLIMETERS			NOTE
	MINIMUM	NOMINAL	MAXIMUM	
A	1.40	1.50	1.60	
A1	0.00	—	0.10	
b	0.38	0.42	0.48	
b1	0.48	0.52	0.58	
b2	1.79	1.82	1.87	
c	0.40	0.42	0.46	
D	4.40	4.50	4.70	
E	3.70	4.00	4.30	
E1	2.40	2.50	2.70	
E2	0.80	1.00	1.20	
E3	0.40	0.50	0.60	
e	1.50 TYP.			
θ	4° TYP.			

※Recommend PCB solder land [Unit: mm]

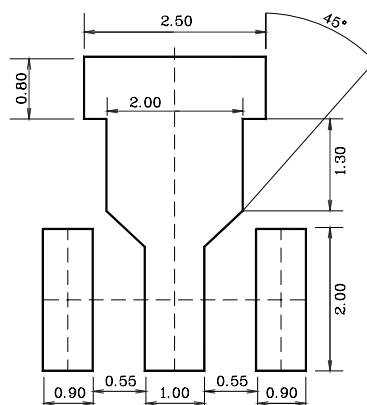

The AUK Corp. products are intended for the use as components in general electronic equipment (Office and communication equipment, measuring equipment, home appliance, etc.).

Please make sure that you consult with us before you use these AUK Corp. products in equipments which require high quality and / or reliability, and in equipments which could have major impact to the welfare of human life(atomic energy control, airplane, spaceship, transportation, combustion control, all types of safety device, etc.). AUK Corp. cannot accept liability to any damage which may occur in case these AUK Corp. products were used in the mentioned equipments without prior consultation with AUK Corp..

Specifications mentioned in this publication are subject to change without notice.