

TOSHIBA PHOTOINTERRUPTER INFRARED LED + PHOTOTRANSISTOR

TLP830

TRACK "00" SENSOR FOR FLOPPY DISK DRIVE
 DETECTION OF SUB-SCANNING QUANTITY BY
 IMAGE SCANNER
 VARIOUS POSITION DETECTION SENSOR

TLP830 is a photointerrupter which uses a high-radiant power GaAs LED and a fast-response Si phototransistor. the device is high resolution with a narrow slit pitch.

- Small package : 7.4mm (H), 4.5mm (D)
- Printed wiring board direct mounting type (with a locating pin).
- Board thickness : 1mm or less
- Short lead type enabling automated mounting
- Gap : 2mm
- High resolution : Slit width 0.15mm
- High current transfer ratio : $I_C / I_F = 3\%$ (min)
- Material of the package : Polybutylene terephthalate (UL94V-0, Black color)
- Detector side is of visible light cut type.

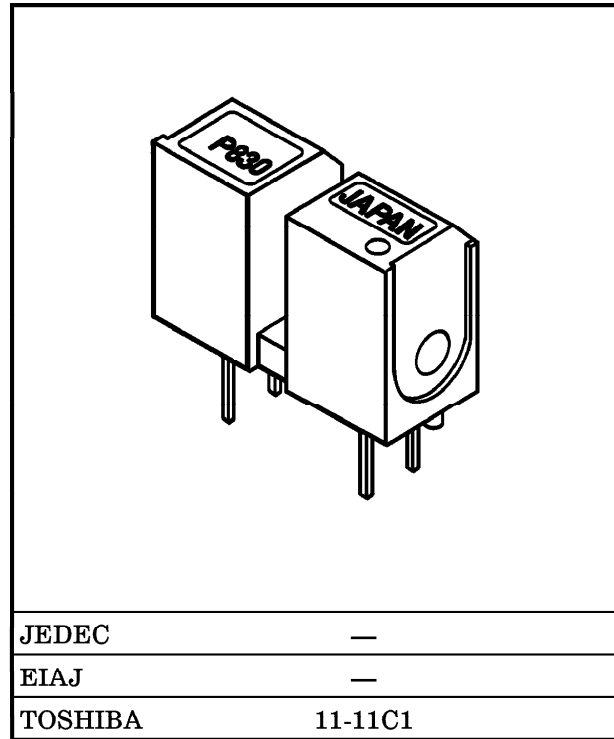

Weight : 0.4g (typ.)

MAXIMUM RATINGS (Ta = 25°C)

CHARACTERISTIC		SYMBOL	RATING	UNIT
LED	Forward Current	I_F	50	mA
	Forward Current Derating (Ta > 25°C)	$\Delta I_F / ^\circ C$	-0.33	mA / °C
	Reverse Voltage	V_R	5	V
DETECTOR	Collector-Emitter Voltage	V_{CEO}	35	V
	Emitter-Collector Voltage	V_{ECO}	5	V
	Collector Power Dissipation	P_C	75	mW
	Collector Power Dissipation Derating (Ta > 25°C)	$\Delta P_C / ^\circ C$	-1	mW / °C
	Collector Current	I_C	50	mA
Operating Temperature Range		T_{opr}	-30~85	°C
Storage Temperature Range		T_{stg}	-40~100	°C
Soldering Temperature (5s)		T_{sol}	260	°C

PRODUCT INDICATION

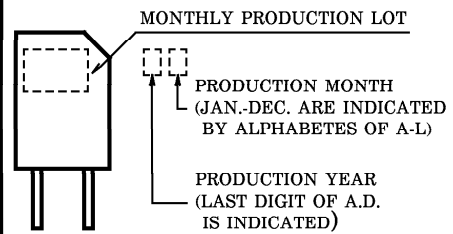

961001EBC2

● TOSHIBA is continually working to improve the quality and the reliability of its products. Nevertheless, semiconductor devices in general can malfunction or fail due to their inherent electrical sensitivity and vulnerability to physical stress. It is the responsibility of the buyer, when utilizing TOSHIBA products, to observe standards of safety, and to avoid situations in which a malfunction or failure of a TOSHIBA product could cause loss of human life, bodily injury or damage to property. In developing your designs, please ensure that TOSHIBA products are used within specified operating ranges as set forth in the most recent products specifications. Also, please keep in mind the precautions and conditions set forth in the TOSHIBA Semiconductor Reliability Handbook.

RECOMMENDED OPERATING CONDITIONS

CHARACTERISTIC	SYMBOL	MIN.	TYP.	MAX.	UNIT
Supply Voltage	V _{CC}	—	5	24	V
Forward Current	I _F	—	—	25	mA
Operating Temperature	T _{opr}	-10	—	75	°C

OPTO ELECTRICAL CHARACTERISTICS (Ta = 25°C)

CHARACTERISTIC		SYMBOL	TEST CONDITION	MIN.	TYP.	MAX.	UNIT	
LED	Forward Voltage	V _F	I _F = 10mA	1.00	1.15	1.30	V	
	Reverse Current	I _R	V _R = 5V	—	—	10	μA	
	Peak Emission Wavelength	λ _P	I _F = 10mA	—	940	—	nm	
DETECTOR	Dark Current	I _D	V _{CE} = 24V, I _F = 0	—	—	0.1	μA	
	Peak Sensitivity Wavelength	λ _P		—	870	—	nm	
COUPLED	Current Transfer Ratio	I _C / I _F	V _{CE} = 2V, I _F = 10mA	3	—	20	%	
	Collector-Emitter Saturation Voltage	V _{CE (sat)}	I _F = 20mA, I _C = 0.3mA	—	0.1	0.35	V	
	Switching Times	Rise Time	t _r	V _{CC} = 5V, I _C = 1mA	—	15	—	μs
		Fall Time	t _f	R _L = 1kΩ	—	15	—	
		Response time (1)	t ₁	V _{CC} = 4.4V, I _C = 13mA	—	—	80	
Response time (2)		t ₂	R _L = 47kΩ (Note)	—	—	800		

Note. t₁, t₂ Test Condition

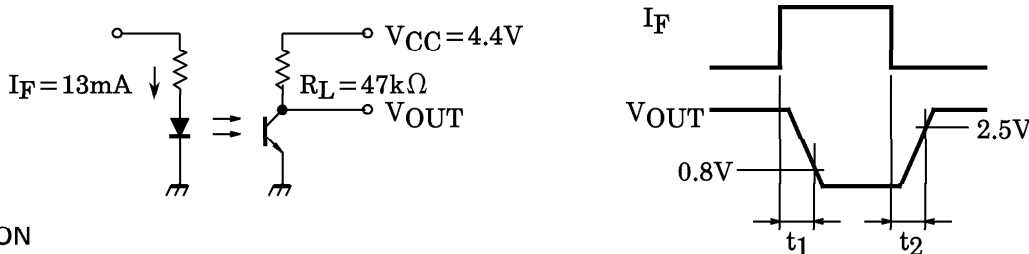

PRECAUTION

1. If the chemical are used for cleaning, the soldered surface only shall be cleaned with chemicals avoiding the whole cleaning of the package.
2. The container is made of polybutylene terephthalate. oil or chemicals may cause melting or cracks. Check the environment carefully before installing.
3. Shall be mounted on an unwarped surface.
4. A visible light cut-off type photo transistor which blocks light with frequencies of 700nm or above is used. However, the device cannot block ambient light with a wavelength of 700nm or more or sunlight. Install avoiding the disturbance light.

961001EBC2'

- Gallium arsenide (GaAs) is a substance used in the products described in this document. GaAs dust and fumes are toxic. Do not break, cut or pulverize the product, or use chemicals to dissolve them. When disposing of the products, follow the appropriate regulations. Do not dispose of the products with other industrial waste or with domestic garbage.
- The products described in this document are subject to foreign exchange and foreign trade control laws.
- The information contained herein is presented only as a guide for the applications of our products. No responsibility is assumed by TOSHIBA CORPORATION for any infringements of intellectual property or other rights of the third parties which may result from its use. No license is granted by implication or otherwise under any intellectual property or other rights of TOSHIBA CORPORATION or others.
- The information contained herein is subject to change without notice.

OUTLINE : TOSHIBA

Unit : mm

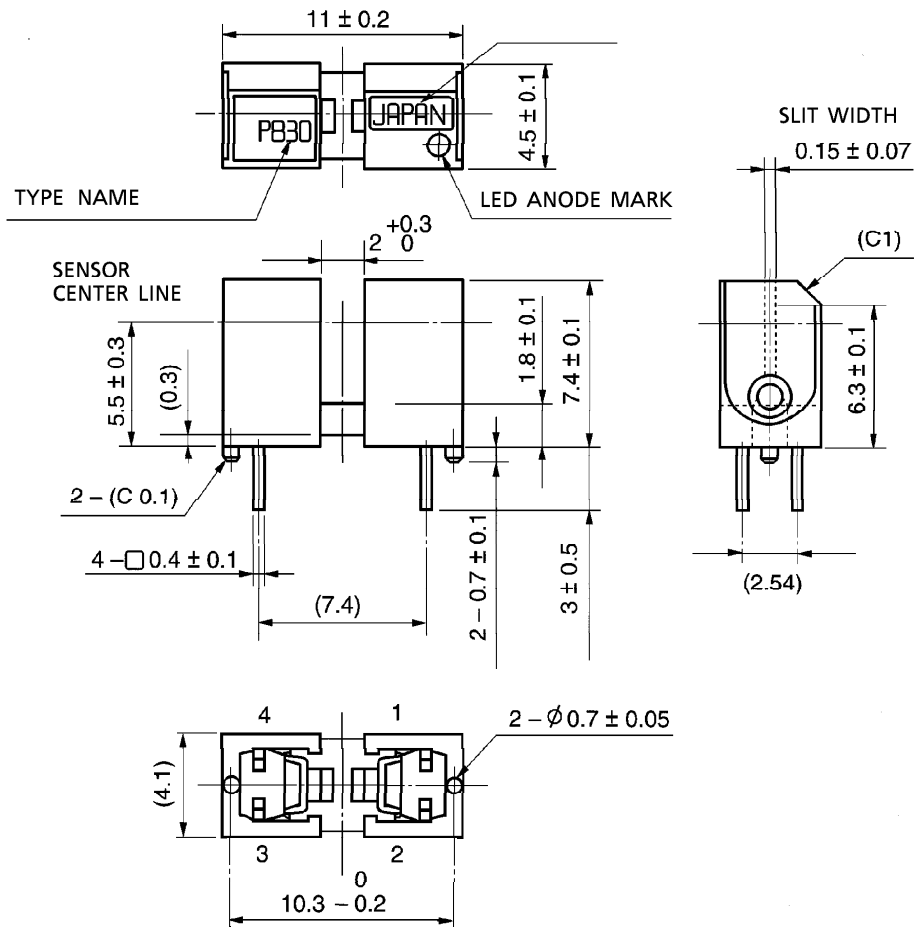

() : REFERENCE VALUE SHIFT

Weight : 0.4g (typ.)

PIN CONNECTIONS

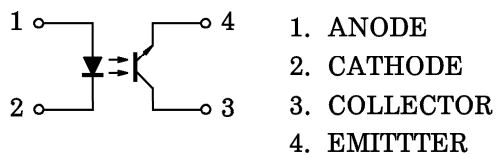

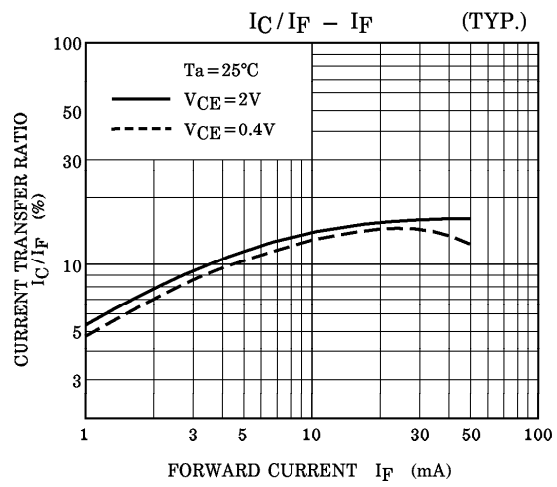
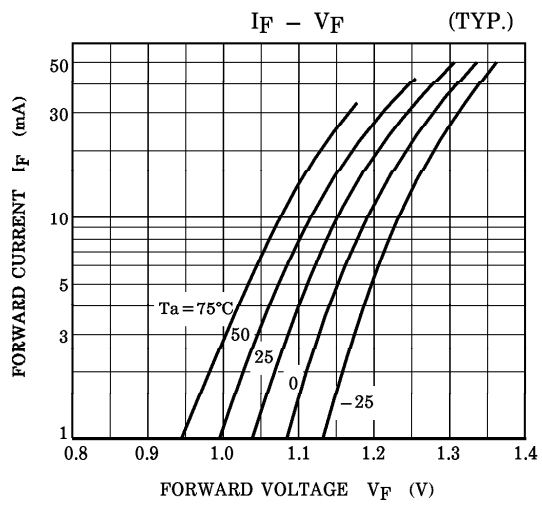
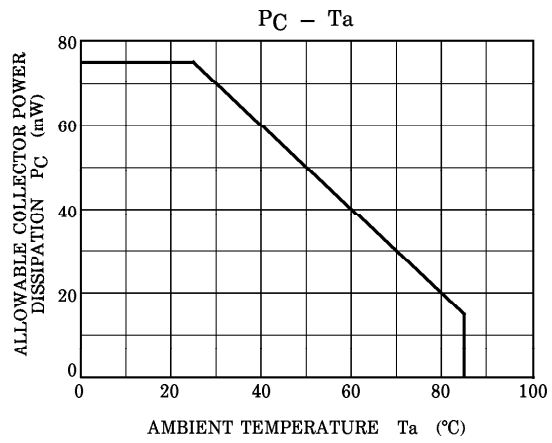
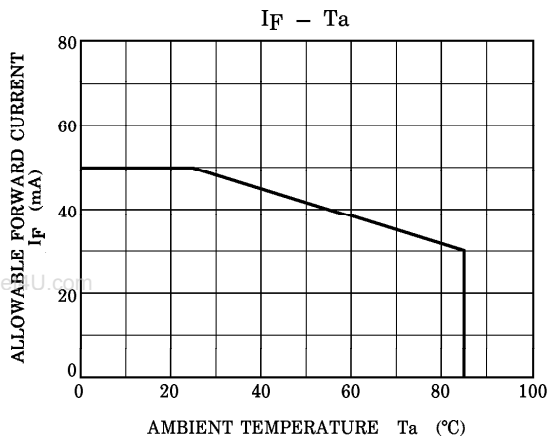

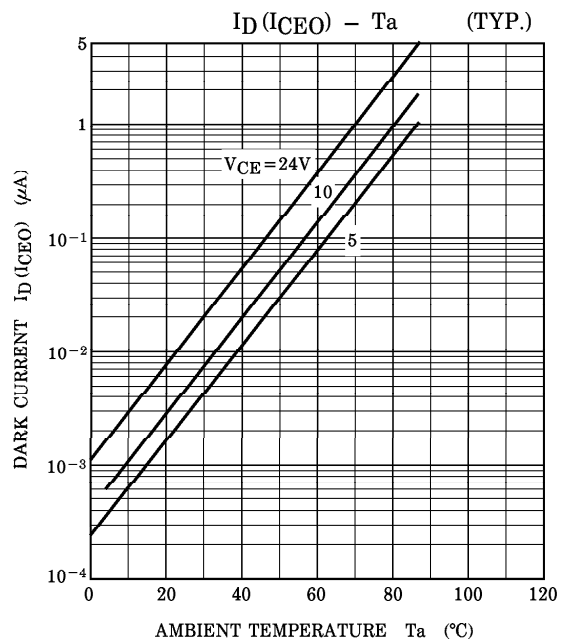
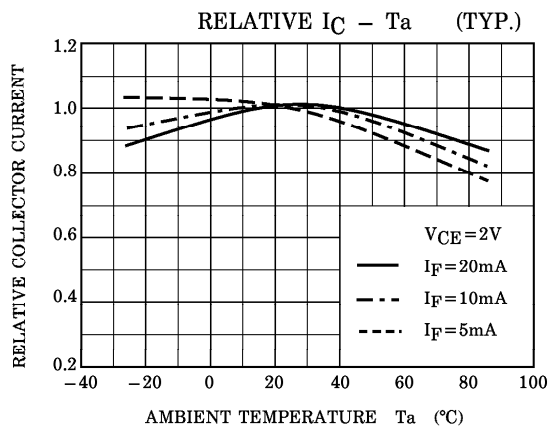
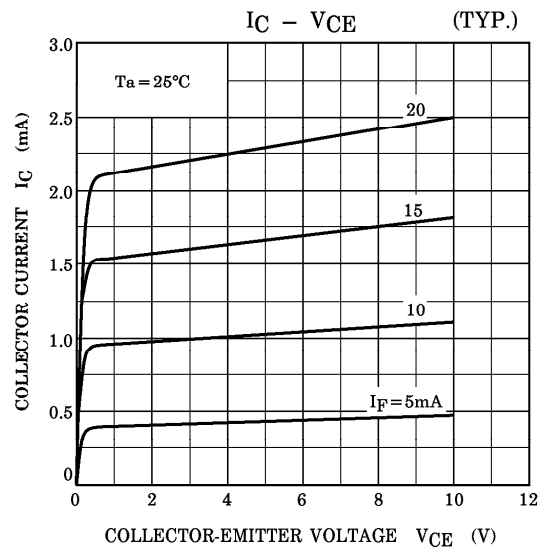
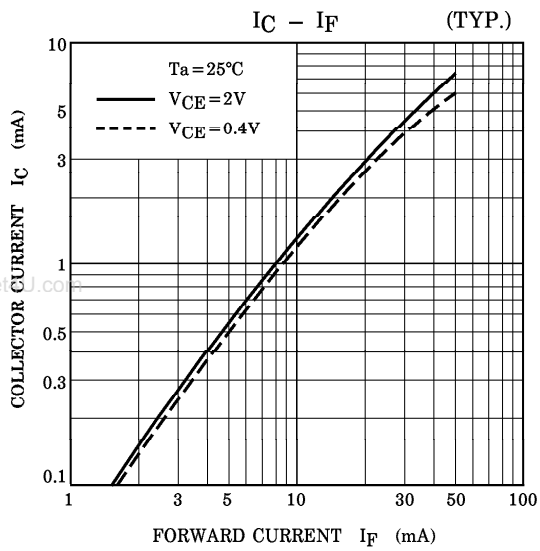

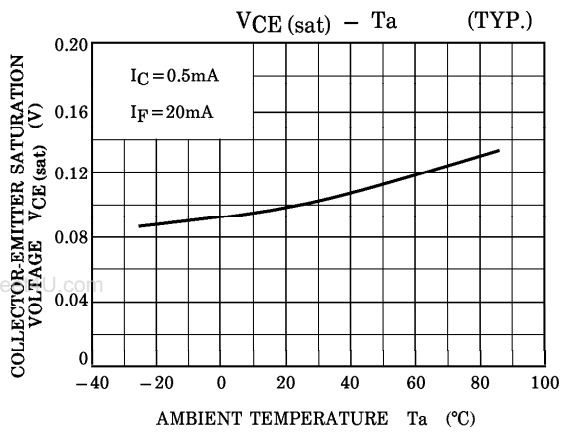

SWITCHING TIME TEST CIRCUIT

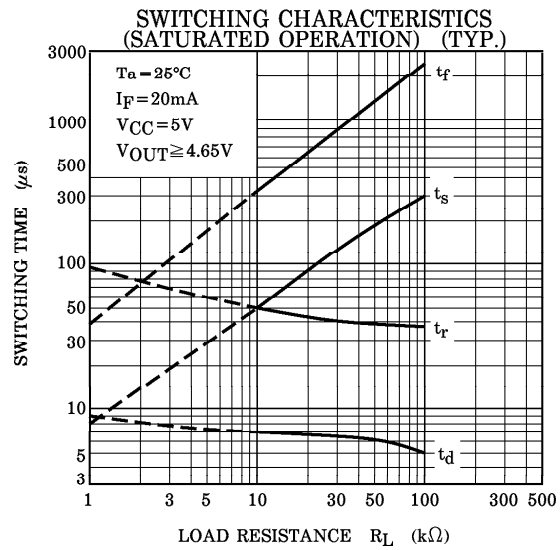
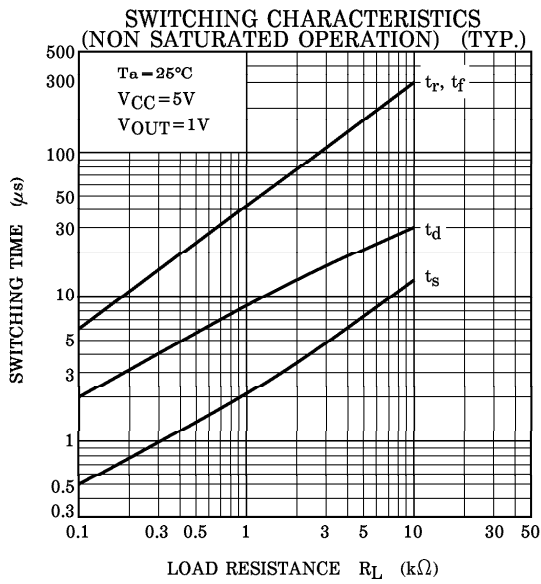
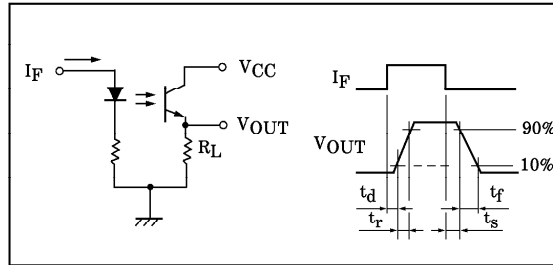

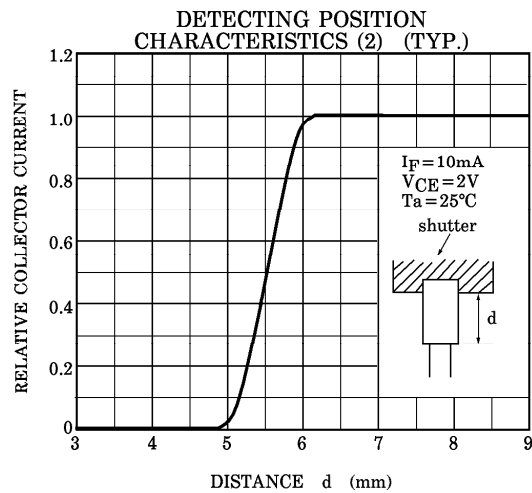
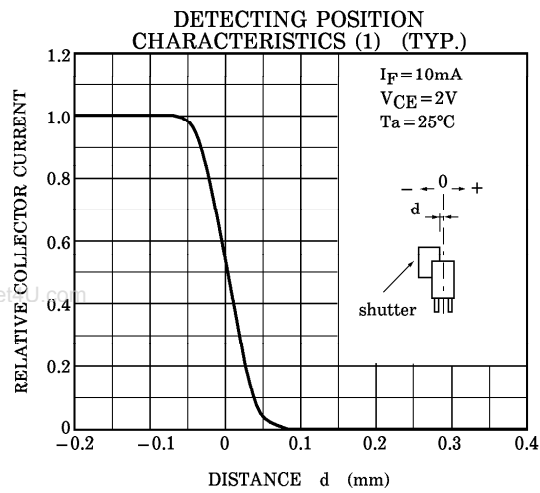

POSITIONING OF SHUTTER AND DEVICE

To operate correctly, make sure that the shutter and the device are positioned as shown in the figure below.

The slit pitch of the shutter must be set wider than the slit width of the device. Determine the width taking the switching time into consideration.

