

PMEG2020EJ

20 V, 2 A very low V_F MEGA Schottky barrier rectifier in SOD323F package

Rev. 02 — 31 January 2005

Product data sheet

1. Product profile

1.1 General description

Planar Maximum Efficiency General Application (MEGA) Schottky barrier rectifier with an integrated guard ring for stress protection encapsulated in a SOD323F (SC-90) very small and flat SMD plastic package.

1.2 Features

- Forward current: 2 A
- Reverse voltage: 20 V
- Very low forward voltage
- Very small and flat SMD package.

1.3 Applications

- Low voltage rectification
- High efficiency DC-to-DC conversion
- Switch mode power supply
- Inverse polarity protection
- Low power consumption applications.

1.4 Quick reference data

Table 1: Quick reference data



Symbol	Parameter	Conditions	Min	Typ	Max	Unit
I_F	continuous forward current	$T_s \leq 55\text{ °C}$	-	-	2	A
V_R	continuous reverse voltage		-	-	20	V
V_F	forward voltage	$I_F = 2\text{ A}$; see Figure 1	[1] -	450	525	mV

[1] Pulse test: $t_p \leq 300\text{ }\mu\text{s}$; $\delta \leq 0.02$.

PHILIPS

2. Pinning information

Table 2: Discrete pinning

Pin	Description	Simplified outline	Symbol
1	cathode ^[1]	 <p>SOD323F</p>	 <p>sym001</p>
2	anode		

[1] The marking bar indicates the cathode.

3. Ordering information

Table 3: Ordering information

Type number	Package		
	Name	Description	Version
PMEG2020EJ	SC-90	plastic surface mounted package; 2 leads	SOD323F

4. Marking

Table 4: Marking codes

Type number	Marking code
PMEG2020EJ	CA

5. Limiting values

Table 5: Limiting values

In accordance with the Absolute Maximum Rating System (IEC 60134).

Symbol	Parameter	Conditions	Min	Max	Unit
V_R	continuous reverse voltage		-	20	V
I_F	continuous forward current	$T_s \leq 55\text{ °C}$	-	2	A
I_{FRM}	repetitive peak forward current	$t_p \leq 1\text{ ms}; \delta \leq 0.5$	-	7	A
I_{FSM}	non-repetitive peak forward current	$t = 8\text{ ms};$ square wave	-	10	A
T_j	junction temperature		-	150	°C
T_{amb}	ambient temperature		-65	+150	°C
T_{stg}	storage temperature		-65	+150	°C

6. Thermal characteristics

Table 6: Thermal characteristics

Symbol	Parameter	Conditions	Min	Typ	Max	Unit	
$R_{th(j-a)}$	thermal resistance from junction to ambient	in free air	[1] [2]	-	-	350	K/W
$R_{th(j-s)}$	thermal resistance from junction to soldering point		[2] [3]	-	-	55	K/W

[1] Refer to standard mounting conditions; see [Figure 5](#).

[2] For Schottky barrier rectifier thermal run-away has to be considered, as in some applications the reverse power losses P_R are a significant part of the total power losses. Nomograms for determining the reverse power losses P_R and $I_{F(AV)}$ rating will be available on request.

[3] Soldering point of cathode tab.

7. Characteristics

Table 7: Characteristics

$T_{amb} = 25^\circ\text{C}$ unless otherwise specified.

Symbol	Parameter	Conditions	Min	Typ	Max	Unit
V_F	forward voltage	see Figure 1	[1]			
		$I_F = 0.01\text{ A}$	-	200	220	mV
		$I_F = 0.1\text{ A}$	-	260	290	mV
		$I_F = 1\text{ A}$	-	370	430	mV
		$I_F = 2\text{ A}$	-	450	525	mV
I_R	reverse current	see Figure 2				
		$V_R = 5\text{ V}$	-	15	50	μA
		$V_R = 10\text{ V}$	-	20	80	μA
		$V_R = 20\text{ V}$	-	45	200	μA
C_d	diode capacitance	$V_R = 5\text{ V}$; $f = 1\text{ MHz}$; see Figure 3	-	50	60	pF

[1] Pulse test: $t_p \leq 300\text{ }\mu\text{s}$; $\delta \leq 0.02$.

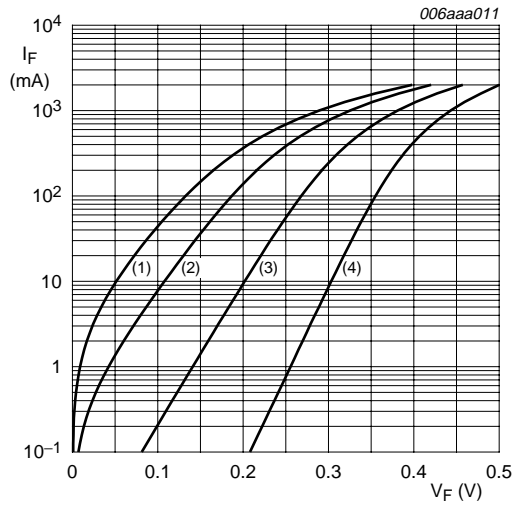

- (1) $T_{amb} = 125\text{ °C}$
- (2) $T_{amb} = 85\text{ °C}$
- (3) $T_{amb} = 25\text{ °C}$
- (4) $T_{amb} = -40\text{ °C}$

Fig 1. Forward current as a function of forward voltage; typical values

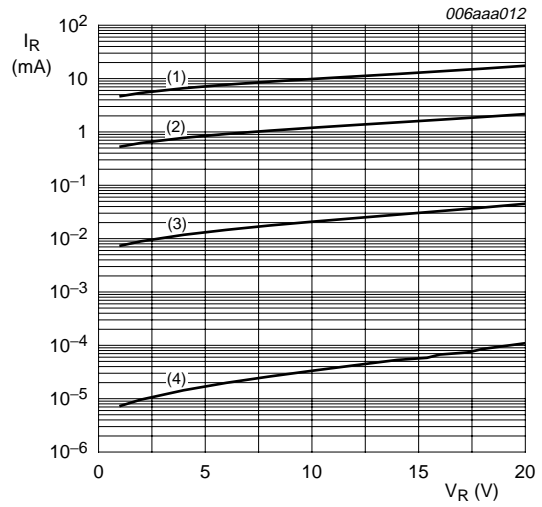

- (1) $T_{amb} = 125\text{ °C}$
- (2) $T_{amb} = 85\text{ °C}$
- (3) $T_{amb} = 25\text{ °C}$
- (4) $T_{amb} = -40\text{ °C}$

Fig 2. Reverse current as a function of reverse voltage; typical values

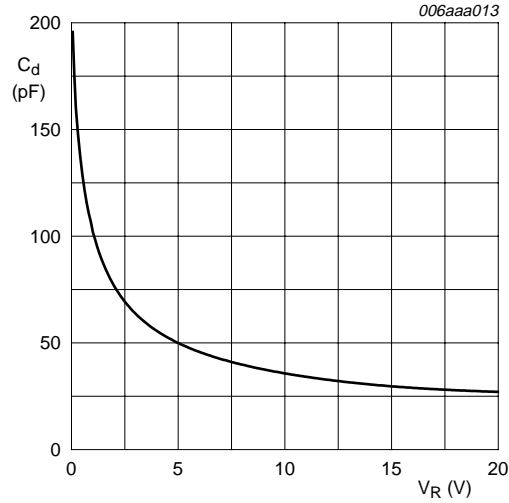

$T_{amb} = 25\text{ °C}; f = 1\text{ MHz.}$

Fig 3. Diode capacitance as a function of reverse voltage; typical values

8. Package outline

Plastic surface mounted package; 2 leads

SOD323F

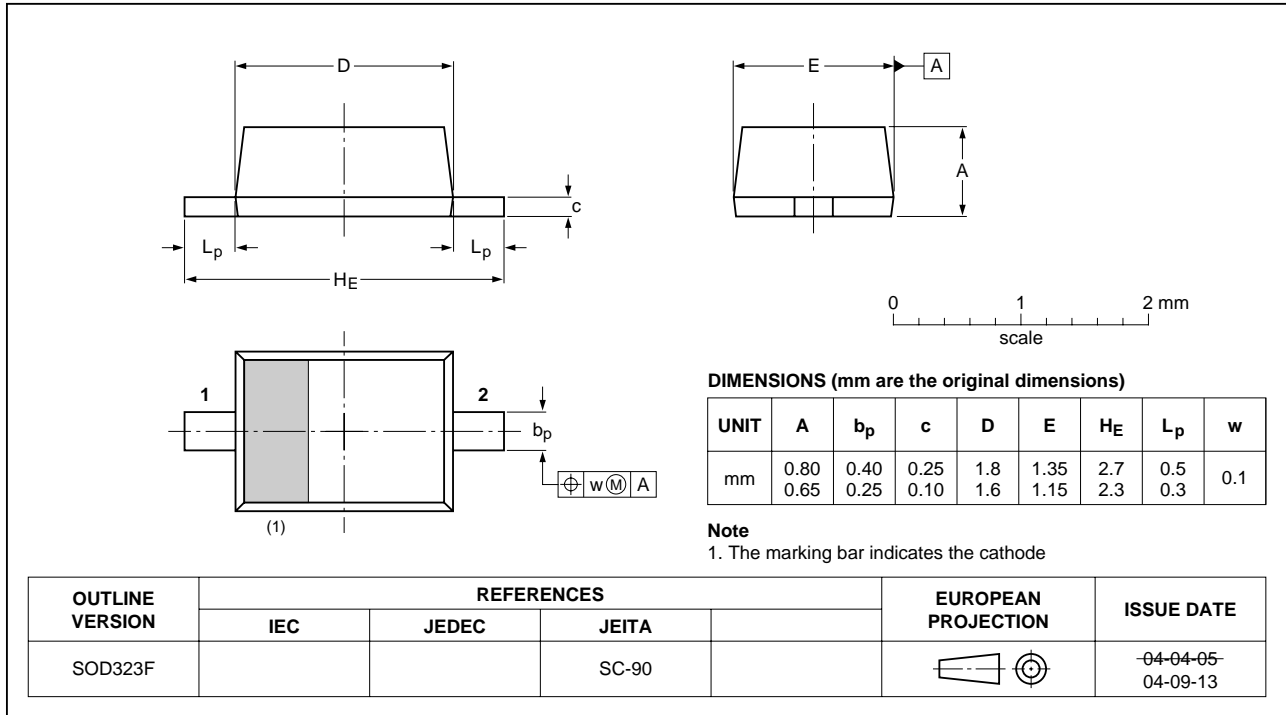

Fig 4. Package outline SOD323F (SC-90)

9. Packing information

Table 8: Packing methods

The indicated -xxx are the last three digits of the 12NC ordering code. [1]

Type number	Package	Description	Packing quantity	
			3000	10000
PMEG2020EJ	SOD323F	4 mm pitch, 8 mm tape and reel	-115	-135

[1] For further information and the availability of packing methods, see [Section 15](#).

10. Soldering

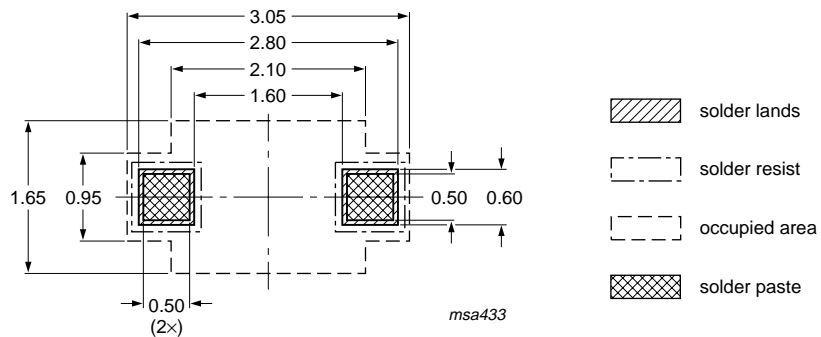

Reflow soldering is the only recommended soldering method.

Dimensions in mm.

Fig 5. Reflow soldering footprint

11. Revision history

Table 9: Revision history

Document ID	Release date	Data sheet status	Change notice	Doc. number	Supersedes
PMEG2020EJ_2	20050131	Product data sheet	-	9397 750 14314	PMEG2020EJ_1
Modifications:					
					<ul style="list-style-type: none">• This data sheet is an enhancement of data sheet PMEG2020EJ_1• Data sheet status changed to Product data sheet
PMEG2020EJ_1	20040830	Preliminary data sheet	-	9397 750 13536	-

12. Data sheet status

Level	Data sheet status [1]	Product status [2] [3]	Definition
I	Objective data	Development	This data sheet contains data from the objective specification for product development. Philips Semiconductors reserves the right to change the specification in any manner without notice.
II	Preliminary data	Qualification	This data sheet contains data from the preliminary specification. Supplementary data will be published at a later date. Philips Semiconductors reserves the right to change the specification without notice, in order to improve the design and supply the best possible product.
III	Product data	Production	This data sheet contains data from the product specification. Philips Semiconductors reserves the right to make changes at any time in order to improve the design, manufacturing and supply. Relevant changes will be communicated via a Customer Product/Process Change Notification (CPCN).

[1] Please consult the most recently issued data sheet before initiating or completing a design.

[2] The product status of the device(s) described in this data sheet may have changed since this data sheet was published. The latest information is available on the Internet at URL <http://www.semiconductors.philips.com>.

[3] For data sheets describing multiple type numbers, the highest-level product status determines the data sheet status.

13. Definitions

Short-form specification — The data in a short-form specification is extracted from a full data sheet with the same type number and title. For detailed information see the relevant data sheet or data handbook.

Limiting values definition — Limiting values given are in accordance with the Absolute Maximum Rating System (IEC 60134). Stress above one or more of the limiting values may cause permanent damage to the device. These are stress ratings only and operation of the device at these or at any other conditions above those given in the Characteristics sections of the specification is not implied. Exposure to limiting values for extended periods may affect device reliability.

Application information — Applications that are described herein for any of these products are for illustrative purposes only. Philips Semiconductors make no representation or warranty that such applications will be suitable for the specified use without further testing or modification.

14. Disclaimers

Life support — These products are not designed for use in life support appliances, devices, or systems where malfunction of these products can reasonably be expected to result in personal injury. Philips Semiconductors customers using or selling these products for use in such applications do so at their own risk and agree to fully indemnify Philips Semiconductors for any damages resulting from such application.

Right to make changes — Philips Semiconductors reserves the right to make changes in the products - including circuits, standard cells, and/or software - described or contained herein in order to improve design and/or performance. When the product is in full production (status 'Production'), relevant changes will be communicated via a Customer Product/Process Change Notification (CPCN). Philips Semiconductors assumes no responsibility or liability for the use of any of these products, conveys no license or title under any patent, copyright, or mask work right to these products, and makes no representations or warranties that these products are free from patent, copyright, or mask work right infringement, unless otherwise specified.

15. Contact information

For additional information, please visit: <http://www.semiconductors.philips.com>

For sales office addresses, send an email to: sales.addresses@www.semiconductors.philips.com

16. Contents

1	Product profile	1
1.1	General description	1
1.2	Features	1
1.3	Applications	1
1.4	Quick reference data	1
2	Pinning information	2
3	Ordering information	2
4	Marking	2
5	Limiting values	2
6	Thermal characteristics	3
7	Characteristics	3
8	Package outline	5
9	Packing information	6
10	Soldering	6
11	Revision history	7
12	Data sheet status	8
13	Definitions	8
14	Disclaimers	8
15	Contact information	8



© Koninklijke Philips Electronics N.V. 2005

All rights are reserved. Reproduction in whole or in part is prohibited without the prior written consent of the copyright owner. The information presented in this document does not form part of any quotation or contract, is believed to be accurate and reliable and may be changed without notice. No liability will be accepted by the publisher for any consequence of its use. Publication thereof does not convey nor imply any license under patent- or other industrial or intellectual property rights.

Date of release: 31 January 2005
Document number: 9397 750 14314

Published in The Netherlands