

3 INVERTER

The KIC7WU04FU is a high speed C²MOS INVERTER fabricated with silicon gate C²MOS technology. It achieves the high speed operation similar to equivalent LSTTL while maintaining the C²MOS low power dissipation. As the internal circuit is composed of single stage inverter, it can be applied for crystal oscillation. All inputs are equipped with protection circuits against static discharge or transient excess voltage.

FEATURES

- High Speed : $t_{pd}=6ns$ (Typ.) at $V_{CC}=5V$.
- Low Power Dissipation : $I_{CC}=1\mu A$ (Max.) at $T_a=25^\circ C$.
- High Noise Immunity : $V_{NIH}=V_{NIL}=10\% V_{CC}$ (Min.).
- Output Drive Capability : 10 LSTTL Loads.
- Symmetrical Output Impedance : $|I_{OH}|=I_{OL}=4mA$ (Min.)
- Balanced Propagation Delays : $t_{pLH} \approx t_{pHL}$
- Wide Operating Voltage Range : $V_{CC(opr)}=2\sim 6V$.

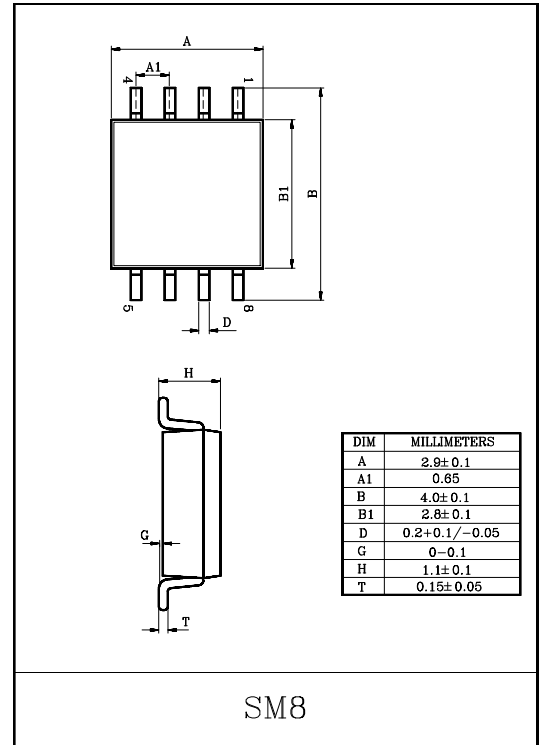

MAXIMUM RATINGS (Ta=25°C)

| CHARACTERISTIC | SYMBOL | RATING | UNIT |
|-----------------------------|-----------|--------------------|------|
| Supply Voltage Range | V_{CC} | -0.5~7 | V |
| DC Input Voltage | V_{IN} | -0.5~ $V_{CC}+0.5$ | V |
| DC Output Voltage | V_{OUT} | -0.5~ $V_{CC}+0.5$ | V |
| Input Diode Current | I_{IK} | ±20 | mA |
| Output Diode Current | I_{OK} | ±20 | mA |
| DC Output Current | I_{OUT} | ±25 | mA |
| DC V_{CC} /Ground Current | I_{CC} | ±25 | mA |
| Power Dissipation | P_D | 300 | mW |
| Storage Temperature | T_{stg} | -65~150 | °C |
| Lead Temperature (10s) | T_L | 260 | °C |

MARKING

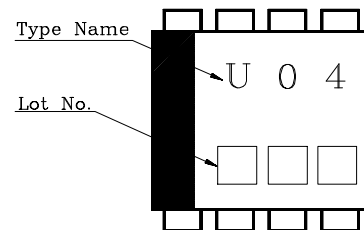

PIN CONNECTION(TOP VIEW)

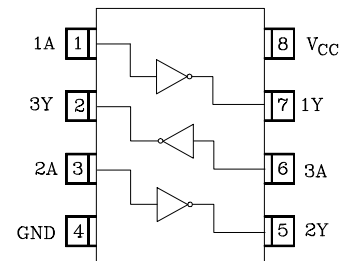

KIC7WU04FU

LOGIC DIAGRAM

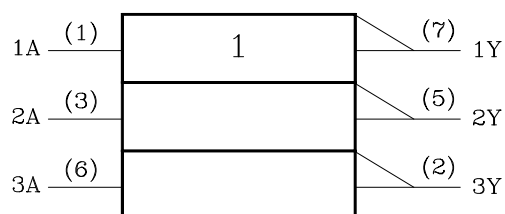

TRUTH TABLE

| A | Y |
|---|---|
| L | H |
| H | L |

RECOMMENDED OPERATING CONDITIONS

| CHARACTERISTIC | SYMBOL | RATING | UNIT |
|-----------------------|-----------|-------------|------|
| Supply Voltage | V_{CC} | 2~6 | V |
| Input Voltage | V_{IN} | 0~ V_{CC} | V |
| Output Voltage | V_{OUT} | 0~ V_{CC} | V |
| Operating Temperature | T_{opr} | -40~85 | °C |

DC ELECTRICAL CHARACTERISTICS

| CHARACTERISTIC | SYMBOL | TEST CONDITION | V_{CC} | $T_a=25^\circ\text{C}$ | | | $T_a=-40\sim 85^\circ\text{C}$ | | UNIT | |
|---------------------------|----------|------------------------|--|------------------------|------|-----------|--------------------------------|-----------|---------------|---|
| | | | | MIN. | TYP. | MAX. | MIN. | MAX. | | |
| High-Level Input Voltage | V_{IH} | - | 2.0 | 1.7 | - | - | 1.7 | - | V | |
| | | | 4.5 | 3.6 | - | - | 3.6 | - | | |
| | | | 6.0 | 4.8 | - | - | 4.8 | - | | |
| Low-Level Input Voltage | V_{IL} | - | 2.0 | - | - | 0.3 | - | 0.3 | V | |
| | | | 4.5 | - | - | 0.9 | - | 0.9 | | |
| | | | 6.0 | - | - | 1.2 | - | 1.2 | | |
| High-Level Output Voltage | V_{OH} | $V_{IN}=V_{IL}$ | $I_{OH}=-20\mu\text{A}$ | 2.0 | 1.8 | 2.0 | - | 1.8 | - | V |
| | | | | 4.5 | 4.0 | 4.5 | - | 4.0 | - | |
| | | $V_{IN}=GND$ | $I_{OH}=-4\text{mA}$ $I_{OH}=-5.2\text{mA}$ | 4.5 | 4.18 | 4.31 | - | 4.13 | - | |
| | | | | 6.0 | 5.68 | 5.80 | - | 5.63 | - | |
| Low-Level Output Voltage | V_{OL} | $V_{IN}=V_{IH}$ | $I_{OL}=20\mu\text{A}$ | 2.0 | - | 0.0 | 0.2 | - | 0.2 | V |
| | | | | 4.5 | - | 0.0 | 0.5 | - | 0.5 | |
| | | $V_{IN}=V_{CC}$ | $I_{OL}=4\text{mA}$ $I_{OL}=5.2\text{mA}$ | 4.5 | - | 0.17 | 0.26 | - | 0.33 | |
| | | | | 6.0 | - | 0.18 | 0.26 | - | 0.33 | |
| Input Leakage Current | I_{IN} | $V_{IN}=V_{CC}$ or GND | 6.0 | - | - | ± 0.1 | - | ± 1.0 | μA | |
| Quiescent Supply Current | I_{CC} | $V_{IN}=V_{CC}$ or GND | 6.0 | - | - | 1.0 | - | 10.0 | | |

KIC7WU04FU

AC ELECTRICAL CHARACTERISTICS ($C_L=15\text{pF}$, $V_{CC}=5\text{V}$, $T_a=25^\circ\text{C}$)

| CHARACTERISTIC | SYMBOL | TEST CONDITION | $T_a=25^\circ\text{C}$ | | | UNIT |
|------------------------|------------------------|----------------|------------------------|------|------|------|
| | | | MIN. | TYP. | MAX. | |
| Output Transition Time | t_{TLH} t_{THL} | - | - | 4 | 8 | ns |
| Propagation Delay Time | t_{pLH} t_{pHL} | - | - | 4 | 8 | ns |

AC ELECTRICAL CHARACTERISTICS ($C_L=50\text{pF}$, Input $t_r=t_f=6\text{ns}$)

| CHARACTERISTIC | SYMBOL | TEST CONDITION | V_{CC} | $T_a=25^\circ\text{C}$ | | | $T_a=-40\sim 85^\circ\text{C}$ | | UNIT |
|-------------------------------|------------------------|----------------|----------|------------------------|------|------|--------------------------------|------|------|
| | | | | MIN. | TYP. | MAX. | MIN. | MAX. | |
| Output Transition Time | t_{TLH} t_{THL} | - | 2.0 | - | 30 | 75 | - | 95 | ns |
| | | | 4.5 | - | 8 | 15 | - | 19 | |
| | | | 6.0 | - | 7 | 13 | - | 16 | |
| Propagation Delay Time | t_{pLH} t_{pHL} | - | 2.0 | - | 18 | 60 | - | 75 | ns |
| | | | 4.5 | - | 6 | 12 | - | 15 | |
| | | | 6.0 | - | 5 | 10 | - | 13 | |
| Input Capacitance | C_{IN} | - | - | 9 | 15 | - | 15 | pF | |
| Power Dissipation Capacitance | C_{PD} | (Note 1) | - | 13 | - | - | - | | |

Note 1 : C_{PD} is defined as the value of internal equivalent capacitance of IC which is calculated from the operating current consumption without load (refer to Test Circuit.)

Average operating current can be obtained by the equation hereunder.

$$I_{CC(\text{opr})} = C_{PD} \cdot V_{CC} \cdot f_{IN} + I_{CC}/3 \text{ (per gate)}$$

SWITCHING CHARACTERISTICS TEST CIRCUIT

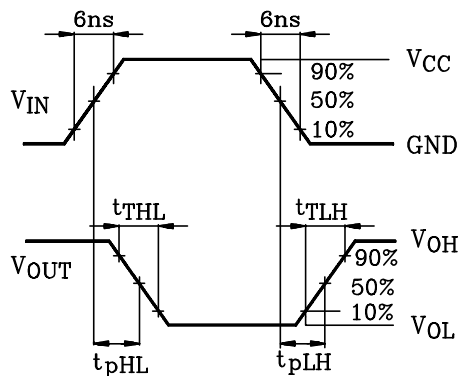
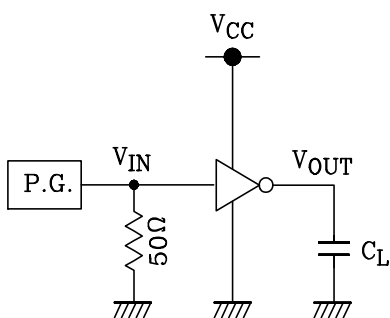

OPERATING CURRENT CONSUMPTION TEST CIRCUIT

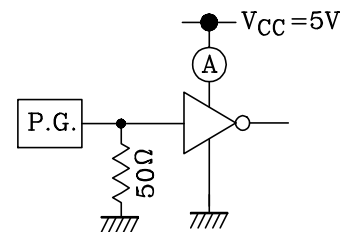

This input waveform is equal to SWITCHING CHARACTERISTICS TEST CIRCUIT input waveform.