

## Features

- 60V/60A,  
 $R_{DS(ON)} = 10m$  (typ.) @  $V_{GS} = 10V$
- Super High Dense Cell Design
- 100% avalanche tested
- Lead Free and Green Devices Available  
 (RoHS Compliant)

## Applications

- DC-DC Converters and Off-line UPS
- High Speed Power Switching
- High Frequency Circuits

## Pin Description

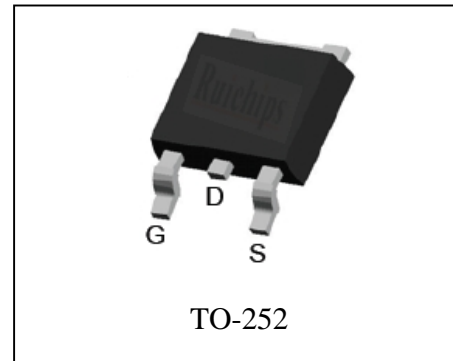

## Absolute Maximum Ratings

Symbol	Parameter	Rating	Unit
<b>Common Ratings</b> ( $T_A = 25^\circ C$ Unless Otherwise Noted)			
$V_{DSS}$	Drain-Source Voltage	60	V
$V_{GSS}$	Gate-Source Voltage	$\pm 25$	
$T_J$	Maximum Junction Temperature	175	$^\circ C$
$T_{STG}$	Storage Temperature Range	-55 to 175	$^\circ C$
$I_S$	Diode Continuous Forward Current	$T_C = 25^\circ C$ 60	A
<b>Mounted on Large Heat Sink</b>			
$I_{DP}$	300 $\mu s$ Pulse Drain Current Tested	$T_C = 25^\circ C$ 240 <sup>①</sup>	A
$I_D$	Continuous Drain Current	$T_C = 25^\circ C$ 60 <sup>②</sup>	A
		$T_C = 100^\circ C$ 45	
$P_D$	Maximum Power Dissipation	$T_C = 25^\circ C$ 97	W
		$T_C = 100^\circ C$ 48	W
$R_{\theta JC}$	Thermal Resistance-Junction to Case	1.55	$^\circ C/W$
<b>Drain-Source Avalanche Ratings</b>			
$E_{AS}$ <sup>③</sup>	Avalanche Energy, Single Pulsed	121	mJ

**Electrical Characteristics** ( $T_A=25^\circ\text{C}$  Unless Otherwise Noted)

Symbol	Parameter	Test Condition	RU6055L			Unit
			Min.	Typ.	Max.	
<b>Static Characteristics</b>						
$BV_{DSS}$	Drain-Source Breakdown Voltage	$V_{GS}=0V, I_{DS}=250\mu A$	60			V
$I_{DSS}$	Zero Gate Voltage Drain Current	$V_{DS}=60V, V_{GS}=0V$ $T_J=85^\circ\text{C}$			1	$\mu A$
					10	
$V_{GS(th)}$	Gate Threshold Voltage	$V_{DS}=V_{GS}, I_{DS}=250\mu A$	2	3	4	V
$I_{GSS}$	Gate Leakage Current	$V_{GS}=\pm 25V, V_{DS}=0V$			$\pm 100$	nA
$R_{DS(ON)}^{(4)}$	Drain-Source On-state Resistance	$V_{GS}=10V, I_{DS}=30A$		10	12	m $\Omega$
<b>Diode Characteristics</b>						
$V_{SD}^{(4)}$	Diode Forward Voltage	$I_{SD}=30A, V_{GS}=0V$		0.8	1.2	V
$t_{rr}$	Reverse Recovery Time	$I_{SD}=30A, di_{SD}/dt=100A/\mu s$		24		ns
$Q_{rr}$	Reverse Recovery Charge			21		nC
<b>Dynamic Characteristics</b> <sup>(5)</sup>						
$R_G$	Gate Resistance	$V_{GS}=0V, V_{DS}=0V, F=1\text{MHz}$		1.0		$\Omega$
$C_{iss}$	Input Capacitance	$V_{GS}=0V,$ $V_{DS}=30V,$ Frequency=1.0MHz		1840		pF
$C_{oss}$	Output Capacitance			300		
$C_{riss}$	Reverse Transfer Capacitance			98		
$t_{d(ON)}$	Turn-on Delay Time			12		
$t_r$	Turn-on Rise Time	$V_{DD}=40V, R_L=30\Omega,$ $I_{DS}=30A, V_{GEN}=10V,$ $R_G=4.7\Omega$		45		
$t_{d(OFF)}$	Turn-off Delay Time			53		
$t_f$	Turn-off Fall Time			31		
<b>Gate Charge Characteristics</b> <sup>(5)</sup>						
$Q_g$	Total Gate Charge	$V_{DS}=48V, V_{GS}=10V,$ $I_{DS}=30A$		45		nC
$Q_{gs}$	Gate-Source Charge			11		
$Q_{gd}$	Gate-Drain Charge			13		

- Notes:
- ① Pulse width limited by safe operating area.
  - ② Calculated continuous current based on maximum allowable junction temperature.
  - ③ Limited by  $T_{Jmax}, I_{AS}=22A, V_{DD}=48V, R_G=50\Omega$ , Starting  $T_J=25^\circ\text{C}$ .
  - ④ Pulse test; Pulse width  $\leq 300\mu s$ , duty cycle  $\leq 2\%$ .
  - ⑤ Guaranteed by design, not subject to production testing.

**Typical Characteristics**

**Power Dissipation**

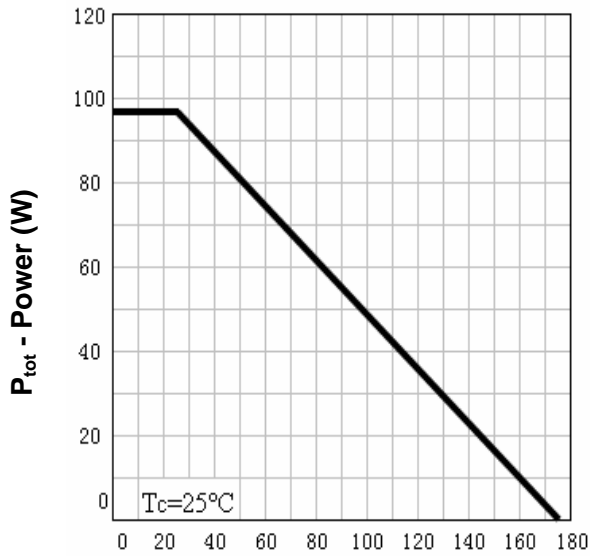

**$T_j$  - Junction Temperature (°C)**

**Drain Current**

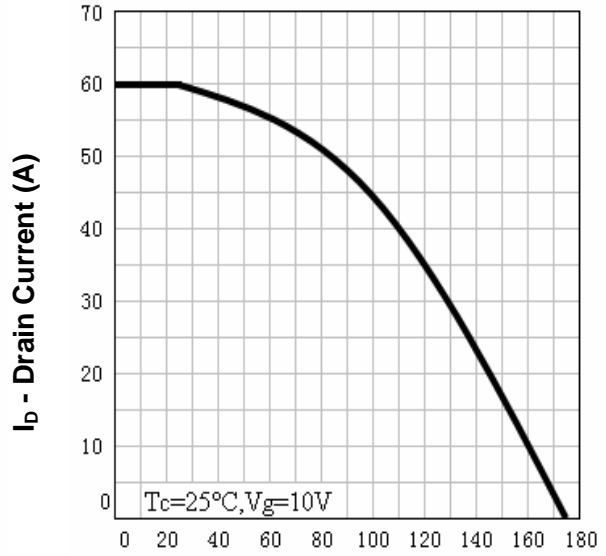

**$T_j$  - Junction Temperature (°C)**

**Safe Operation Area**

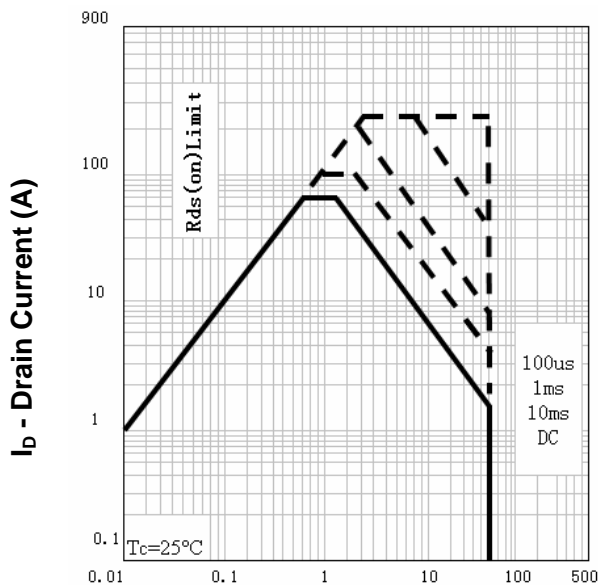

**$V_{DS}$  - Drain-Source Voltage (V)**

**Thermal Transient Impedance**

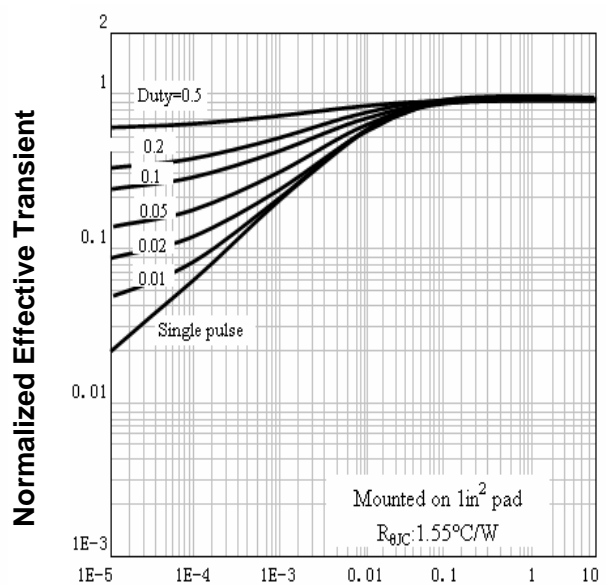

**Square Wave Pulse Duration (sec)**

**Typical Characteristics**

**Output Characteristics**

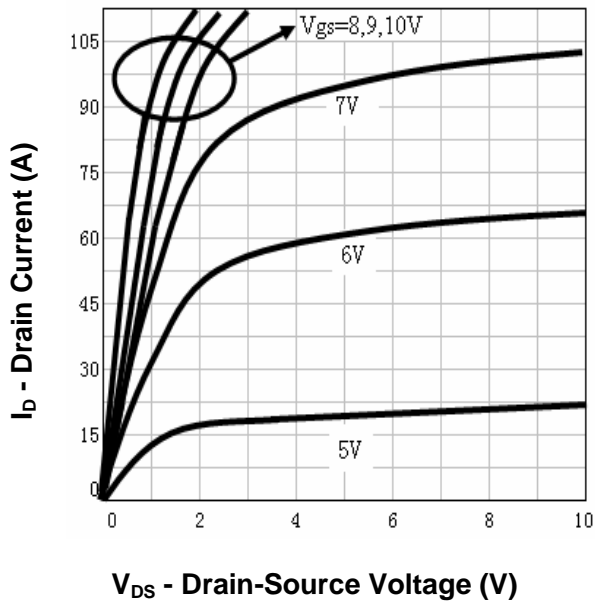

**Drain-Source On Resistance**

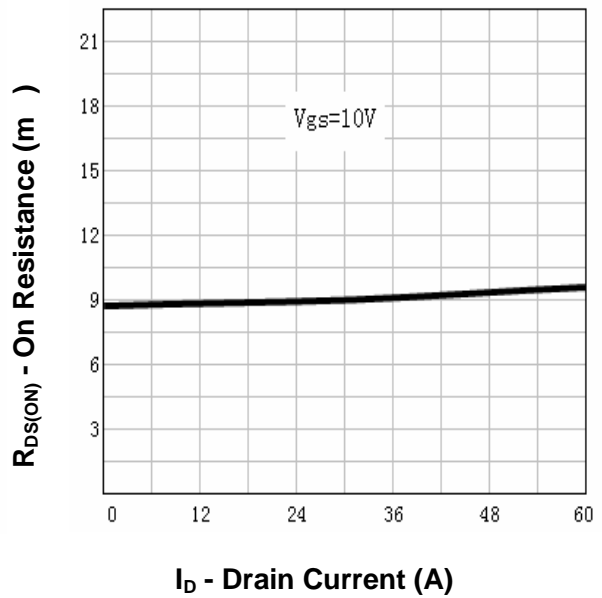

**Drain-Source On Resistance**

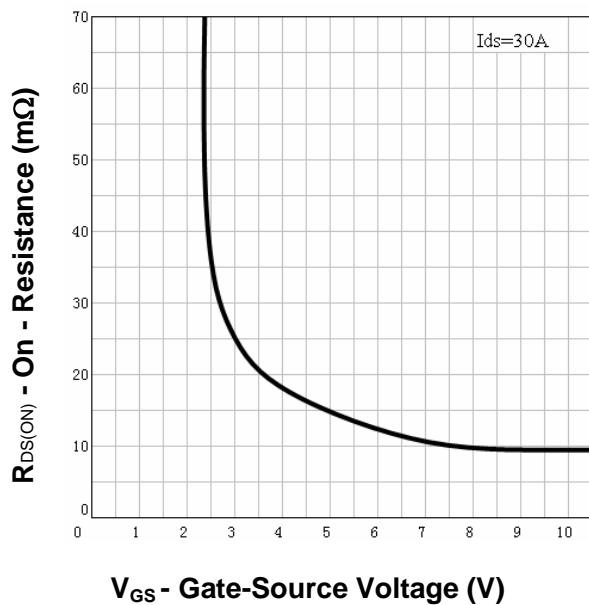

**Gate Threshold Voltage**

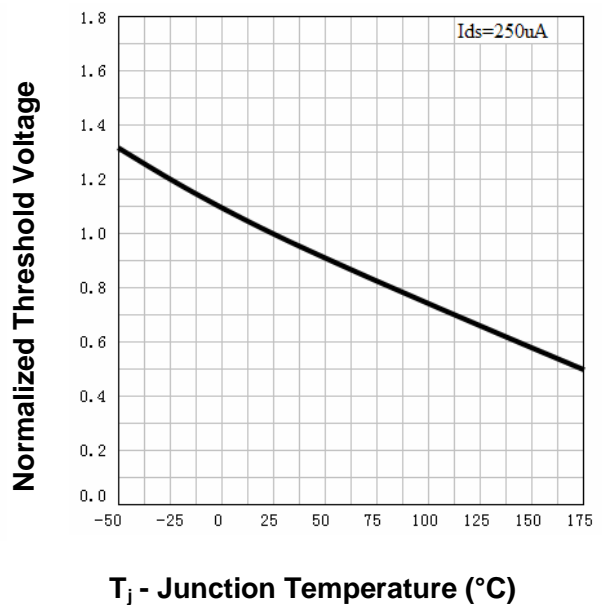

**Typical Characteristics**

**Drain-Source On Resistance**

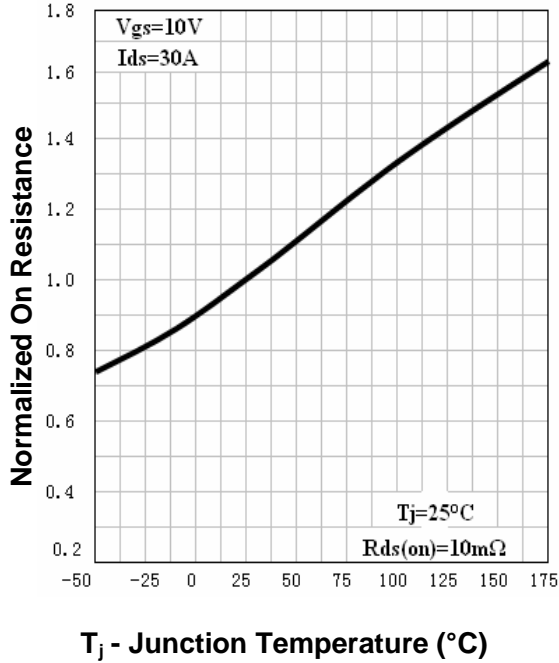

**Source-Drain Diode Forward**

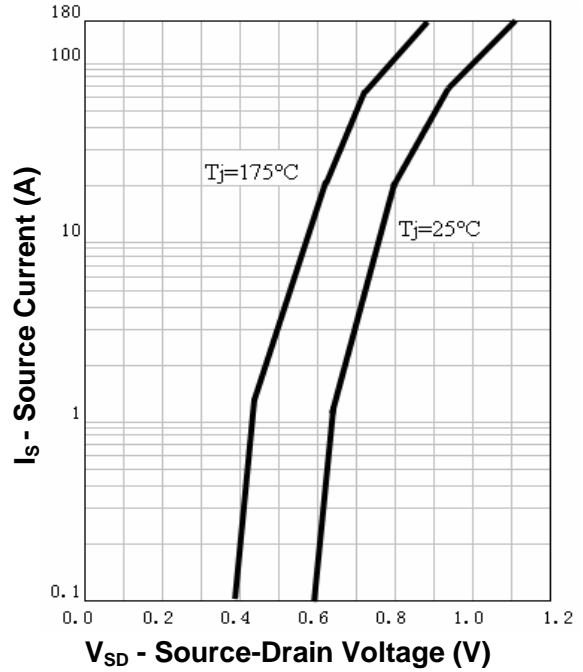

**Capacitance**

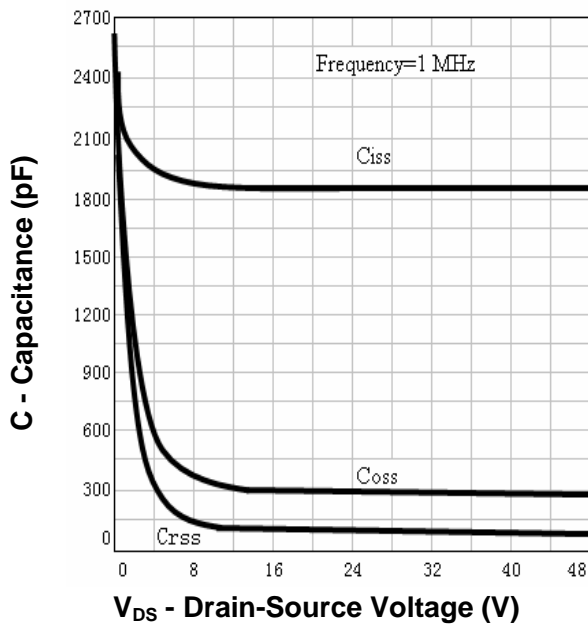

**Gate Charge**

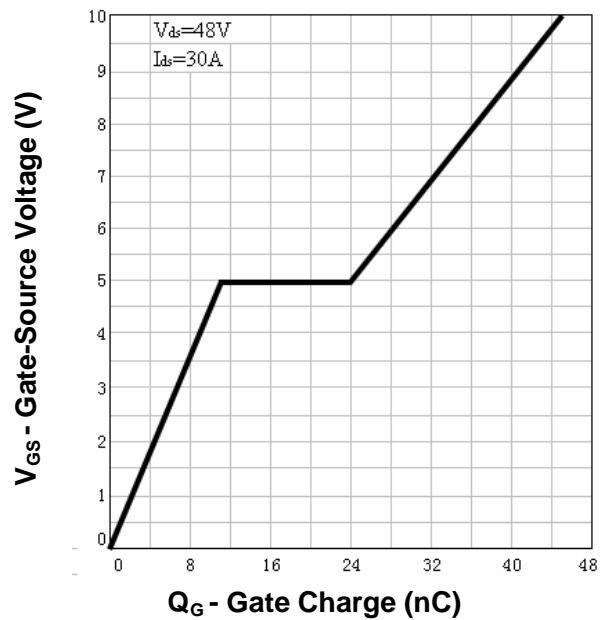

**Avalanche Test Circuit and Waveforms**

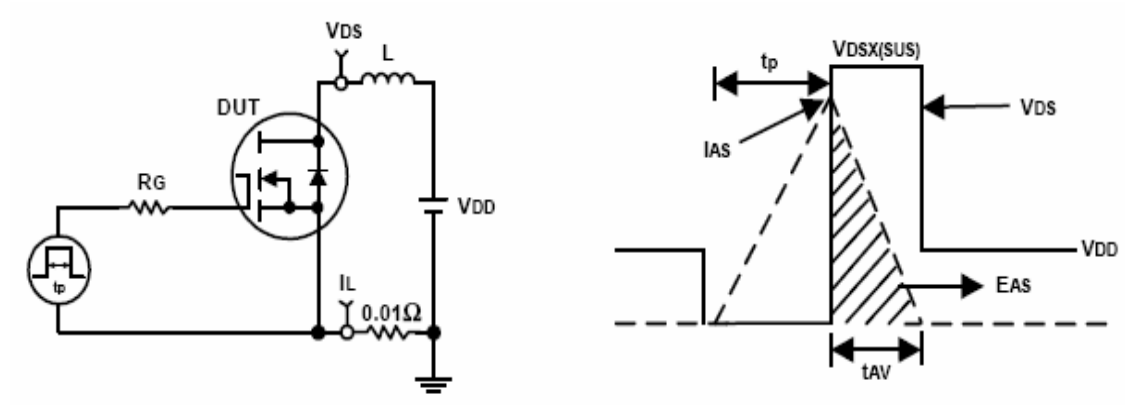

**Switching Time Test Circuit and Waveforms**

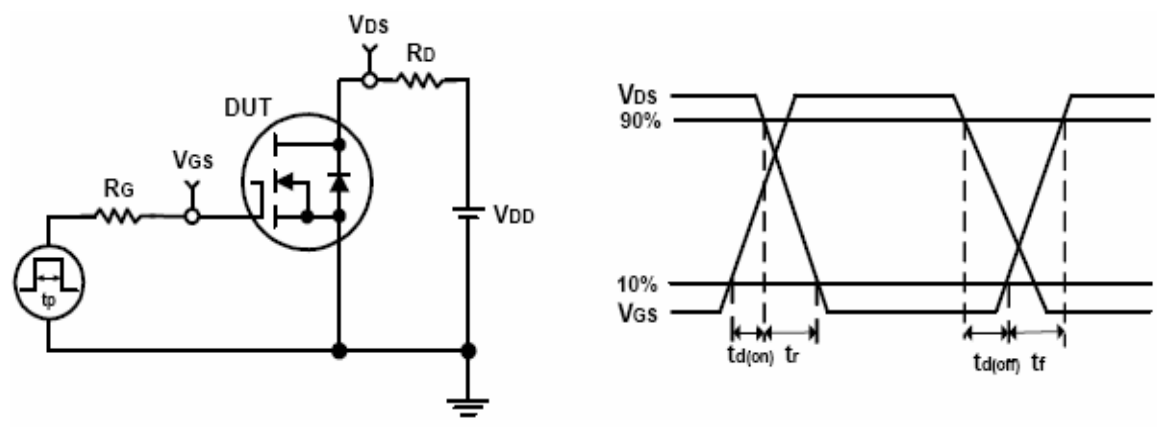

**Ordering and Marking Information****RU6055****Package (Available)**

L : TO252

**Operating Temperature Range**

C : -55 to 175 °C

**Assembly Material**

G : Green &amp; Lead Free

**Packaging**

T : TUBE

TR: Tape &amp; Reel

**Package Information**

**TO252-2L**

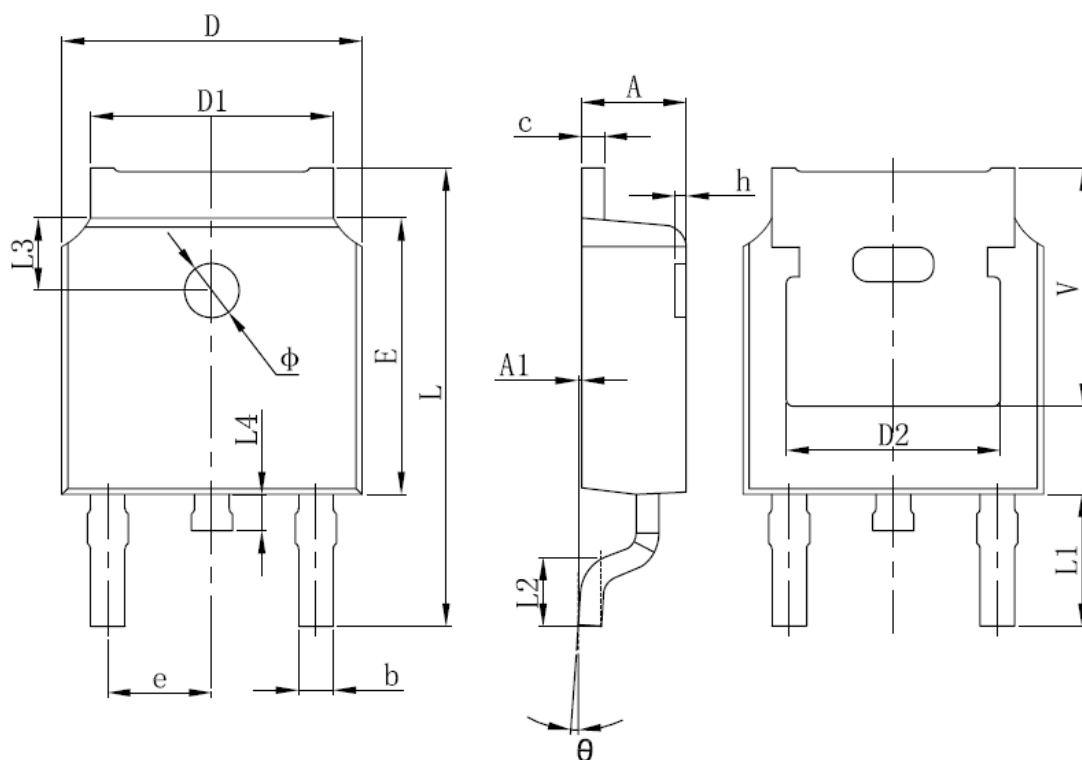

SYMBOL	MM		INCH		SYMBOL	MM		INCH	
	MIN	MAX	MIN	MAX		MIN	MAX	MIN	MAX
A	2.200	2.400	0.087	0.094	L	9.800	10.400	0.386	0.409
A1	0.000	0.127	0.000	0.005	L1	2.900 REF.		0.114 REF.	
b	0.660	0.860	0.026	0.034	L2	1.400	1.700	0.055	0.067
C	0.460	0.580	0.018	0.023	L3	1.600 REF.		0.063 REF.	
D	6.500	6.700	0.256	0.264	L4	0.600	1.000	0.024	0.039
D1	5.100	5.460	0.201	0.215	Φ	1.100	1.300	0.043	0.051
D2	4.830 REF.		0.190 REF.		θ	0°	8°	0°	8°
E	6.000	6.200	0.236	0.244	h	0.000	0.300	0.000	0.012
e	2.186	2.386	0.086	0.094	V	5.350 REF.		0.211 REF.	

ALL DIMENSIONS REFER TO JEDEC STANDARD  
DO NOT INCLUDE MOLD FLASH OR PROTRUSIONS



## **Customer Service**

**Worldwide Sales and Service:**

Sales@ruichips.com

**Technical Support:**

Technical@ruichips.com

**Investor Relations Contacts:**

Investor@ruichips.com

**Marcom Contact:**

Marcom@ruichips.com

**Editorial Contact:**

Editorial@ruichips.com

**HR Contact:**

HR@ruichips.com

**Legal Contact:**

Legal@ruichips.com

**Shen Zhen RUICHIPS Semiconductor CO., LTD**

Room 501, the 5floor An Tong Industrial Building,  
NO.207 Mei Hua Road Fu Tian Area Shen Zhen City, CHINA

**TEL:** (86-755) 8311-5334

**FAX:** (86-755) 8311-4278

**E-mail:** Sales-SZ@ruichips.com