

PLEASE CHECK WWW.MOLEX.COM FOR LATEST PART INFORMATION

Part Number: [0442810002](#)
Status: **Active**
Description: 4.20mm (.165") Pitch Mini-Fit® Test Plug, Dual Row, 6 Circuits

Documents:

[3D Model](#) [Product Specification PS-44281-001 \(PDF\)](#)
[Drawing \(PDF\)](#) [RoHS Certificate of Compliance \(PDF\)](#)

General

Product Family	PCB Headers
Series	44281
Application	Board-to-Board, Wire-to-Board
Product Literature Order No	USA-053
Product Name	Mini-Fit®

Physical

Breakaway	No
Circuits (Loaded)	6
Circuits (maximum)	6
Durability (mating cycles max)	10,000
First Mate / Last Break	No
Glow-Wire Compliant	No
Guide to Mating Part	No
Keying to Mating Part	None
Lock to Mating Part	Yes
Material - Plating Mating	Gold
Number of Rows	2
Orientation	Vertical
PC Tail Length (in)	0.250 In
PC Tail Length (mm)	6.35 mm
PCB Locator	No
PCB Retention	None
Packaging Type	Bag
Pitch - Mating Interface (in)	0.165 In
Pitch - Mating Interface (mm)	4.20 mm
Pitch - Term. Interface (in)	0.165 In
Pitch - Term. Interface (mm)	4.20 mm
Polarized to Mating Part	Yes
Polarized to PCB	No
Shrouded	Fully
Stackable	No
Surface Mount Compatible (SMC)	No
Temperature Range - Operating	-40°C to +105°C
Termination Interface: Style	Through Hole

Electrical

Current - Maximum per Contact	2.5A
Voltage - Maximum	600V

Material Info

Reference - Drawing Numbers

Product Specification	PS-44281-001
Sales Drawing	SD-44281-001

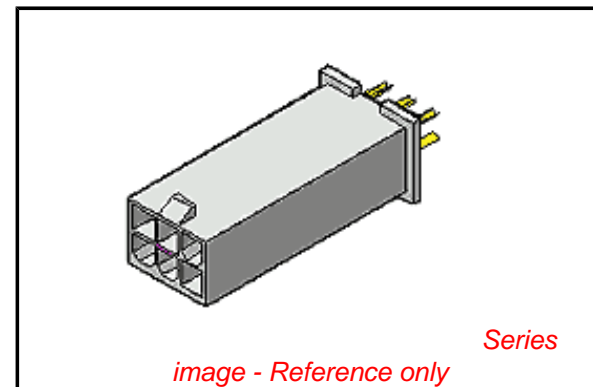

EU RoHS

**ELV and RoHS
Compliant**
**REACH SVHC
Not Reviewed**
**Halogen-Free
Status
Not Reviewed**

China RoHS



**Need more information on product
environmental compliance?**

Email productcompliance@molex.com
 For a multiple part number RoHS Certificate of
 Compliance, [click here](#)

Please visit the [Contact Us](#) section for any
 non-product compliance questions.

Search Parts in this Series

44281Series

Mates With

42474 , 44516 , 5557d

This document was generated on 04/21/2010

PLEASE CHECK WWW.MOLEX.COM FOR LATEST PART INFORMATION

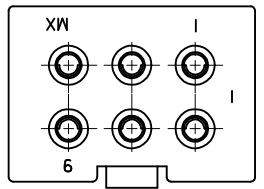

- NOTES:**
- MATERIAL:**
HOUSING: 4/6 NYLON, 30% GLASS FILLED,COLOR BLACK.
POGO-PIN PROBE:HEAT TREATED BERYLLIUM COPPER.
POGO-PIN RECEPTACLE:WORK-HARDENED NICKEL SILVER.
 - FINISH:**
POGO-PIN PROBE:GOLD PLATED OVER HARD NICKEL.
POGO-PIN RECEPTACLE:GOLD PLATED OVER HARD NICKEL.
 - PRODUCT SPECIFICATION:** PS-44281-001.
 - THIS PART MATES WITH RECEPTACLE 5557.**
 - PRODUCT IS INTENDED FOR LOW LEVEL CONTINUITY TESTING ONLY.**
 - SOLDER CUP WILL ACCEPT 22-26 GAUGE WIRE.**

MATERIAL NUMBER	CIRCUIT NUMBER	DIM. "A"	DIM. "B"
44281-0001	4	.378/(9.60)	.165/(4.20)
44281-0002	6	.543/(13.80)	.331/(8.40)
44281-0003	8	.709/(18.00)	.496/(12.60)
44281-0004	10	.874/(22.20)	.661/(16.80)
44281-0005	12	1.039/(26.40)	.827/(21.00)
44281-0006	14	1.205/(30.60)	.992/(25.20)
44281-0007	16	1.370/(34.80)	1.157/(29.40)
44281-0008	18	1.535/(39.00)	1.323/(33.60)
44281-0009	20	1.701/(43.20)	1.488/(37.80)
44281-0010	22	1.866/(47.40)	1.654/(42.00)
44281-0011	24	2.031/(51.60)	1.819/(46.20)
44281-0012	36	3.023/(76.80)	2.811/(71.40)
44281-0013	40	3.353/(85.20)	3.142/(79.80)

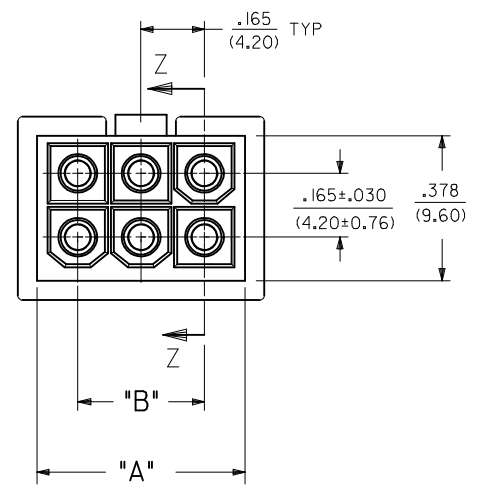
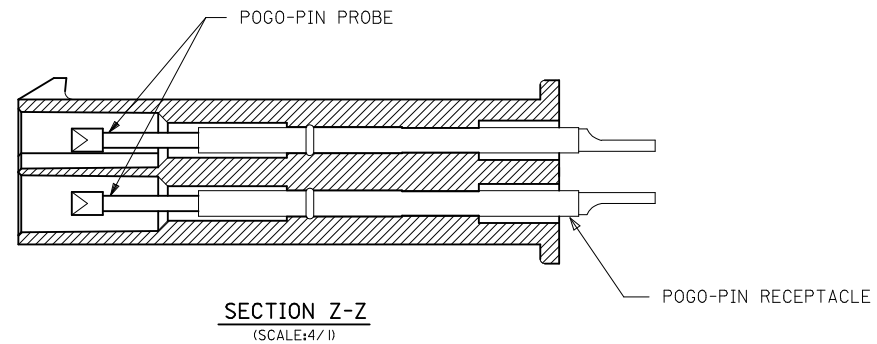
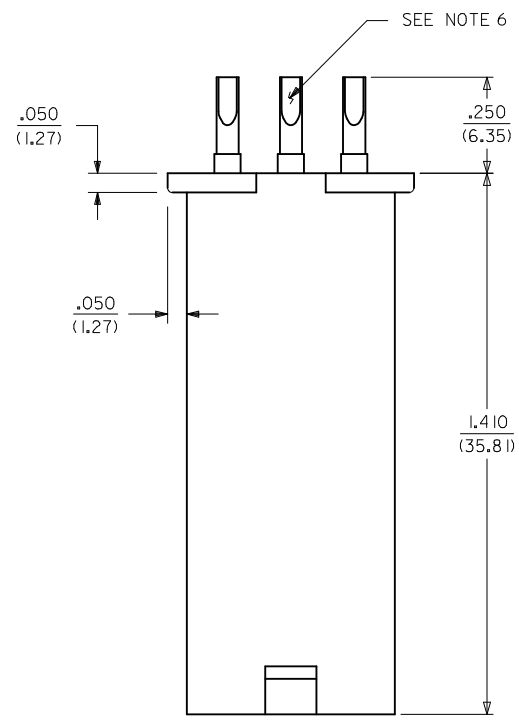

CORRECT CHART EC NO: UCP2010-0584 DRWN: JAGUILAR 2009/09/14 CHKD: J BELL 2009/09/14 APPR: F SMITH 2009/09/15	QUALITY SYMBOLS ▽=0 ▽=0	GENERAL TOLERANCES (UNLESS SPECIFIED)		DIMENSION STYLE IN/MM	SCALE 4:1	DESIGN UNITS METRIC	THIRD ANGLE PROJECTION
		4 PLACES ± --- ± --- 3 PLACES ± --- ± .010 2 PLACES ± 0.25 ± .014 1 PLACE ± 0.35 ± ---	mm INCH ± --- ± --- ± .010 ± .014 ± 0.25 ± ---	DRAWN BY A.GUZIK	DATE 98/11/02	TITLE MINI-FIT 4-24 36 AND 40 CIRCUIT TEST PLUG ASSEMBLY	MOLEX INCORPORATED
B1	DESCRIPTION TEST PLUG ASSEMBLY	DRAFT WHERE APPLICABLE MUST REMAIN WITHIN DIMENSIONS		APPROVED BY EDGLEY	DATE 98/11/03	MATERIAL NO. SEE CHART	DOCUMENT NO. SD-44281-001
THIS DRAWING CONTAINS INFORMATION THAT IS PROPRIETARY TO MOLEX INCORPORATED AND SHOULD NOT BE USED WITHOUT WRITTEN PERMISSION							