



Technical Data Sheet

3.0mm Round Type LED Lamps

204-10UYOC/S530-A3

■ Features :

- Choice of various viewing angles
- Available on tape and reel.
- Reliable and robust
- Pb free
- The product itself will remain within RoHS compliant version.

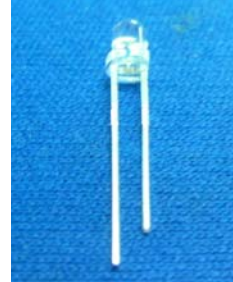

■ Descriptions :

- The series is specially designed for applications requiring higher brightness
- The led lamps are available with different colors, intensities,

■ Applications :

- TV set
- Monitor
- Telephone
- Computer

PART NO.	Material	Emitted Color	Lens Color
204-10UYOC/S530-A3	AlGaInP	Yellow Orange	Water Clear



Technical Data Sheet

3.0mm Round Type LED Lamps

204-10UYOC/S530-A3

Package Dimensions

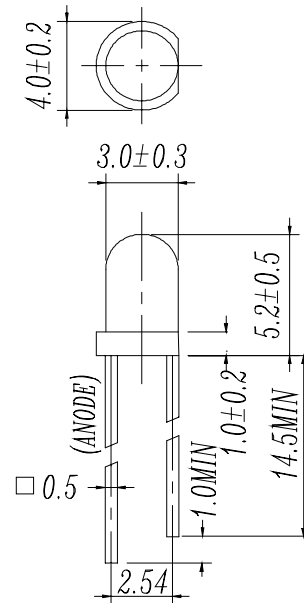

Notes: 1. All dimensions are in millimetres

2. An epoxy meniscus may extend about 1.5mm(0.059") down to the lead.
3. Tolerances unless Dimension ± 0.25 mm.

Absolute Maximum Ratings at $T_a = 25^\circ\text{C}$

Parameter	Symbol	Rating	Unit
Forward Current	I_F	25	mA
Operating Temperature	T_{opr}	-40 to +85	$^\circ\text{C}$
Storage Temperature	T_{stg}	-40 to +100	$^\circ\text{C}$
Electrostatic Discharge	ESD	2000	V
Soldering Temperature	T_{sol}	260 ± 5	$^\circ\text{C}$
Power Dissipation	P_d	60	mW
Peak Forward Current	$I_F(\text{Peak})$	160	mA
Reverse Voltage	V_R	5	V

Note: *1: I_F Conditions --Pulse Width $\leq 1\text{msec}$ and Duty $\leq 1/10$.

*2:Soldering time ≤ 5 seconds.



Technical Data Sheet
3.0mm Round Type LED Lamps

204-10UYOC/S530-A3

Electro-Optical Characteristics (Ta=25°C)

Parameter	Symbol	Condition	Min.	Typ.	Max.	Unit
Forward Voltage	VF	I _F = 20 mA	/	2.0	2.4	V
Reverse Current	IR	V _R = 5 V	/	/	10	μA
Luminous Intensity	I _v	I _F = 20 mA	320	500	/	mcd
Viewing Angle	2θ 1/2	I _F = 20 mA	/	30	/	deg
Peak Wavelength	λ _p	I _F = 20 mA	/	611	/	nm
Dominant Wavelength	λ _d	I _F = 20 mA	/	605	/	nm
Spectrum Radiation Bandwidth	Δλ	I _F = 20 mA	/	17	/	nm



Technical Data Sheet

3.0mm Round Type LED Lamps

204-10UYOC/S530-A3

Typical Electro-Optical Characteristic Curves:

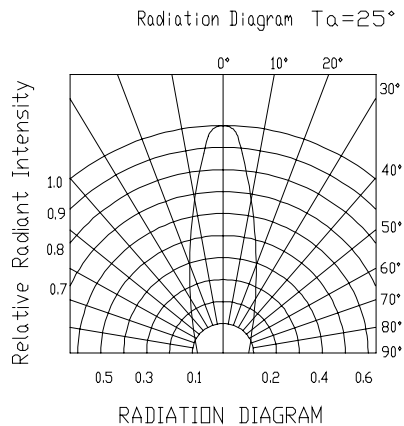
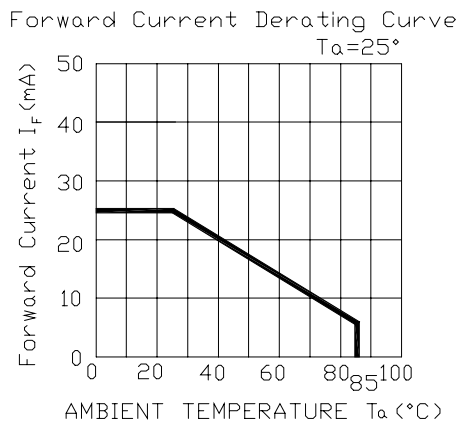
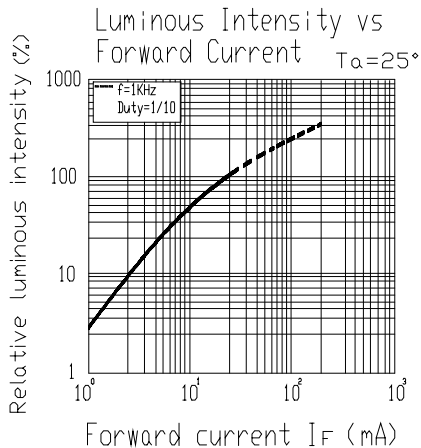
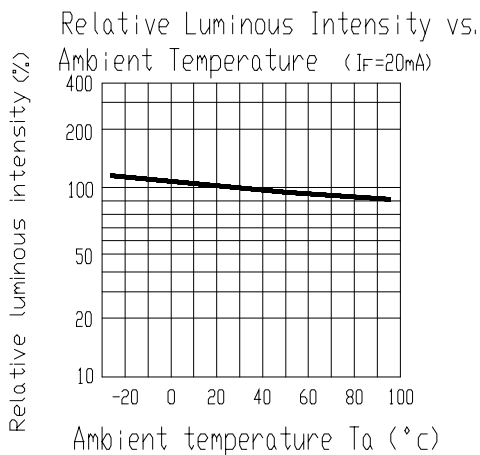
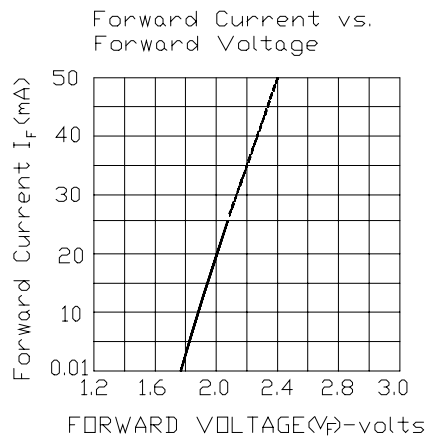
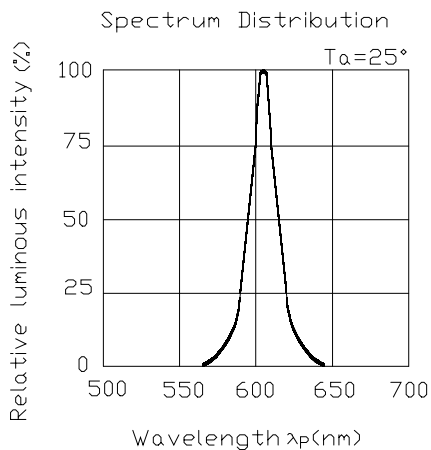



Technical Data Sheet
3.0mm Round Type LED Lamps

204-10UYOC/S530-A3

■ Reliability test items and conditions:

NO	Item	Test Conditions	Test Hours/Cycle	Sample size	Ac/Re
1	Solder Heat	TEMP : 260°C ± 5 °C	10 SEC	76 PCS	0/1
2	Temperature Cycle	H : +100°C 15min ∫ 5 min L : -40°C 15min	300 CYCLES	76 PCS	0/1
3	Thermal Shock	H : +100°C 5min ∫ 10 sec L : -10°C 5min	300 CYCLES	76 PCS	0/1
4	High Temperature Storage	TEMP : 100°C	1000 HRS	76 PCS	0/1
5	Low Temperature Storage	TEMP : -40°C	1000 HRS	76 PCS	0/1
6	DC Operating Life	TEMP : 25°C IF = 20mA	1000 HRS	76 PCS	0/1
7	High Temperature / High Humidity	85°C / 85% RH	1000 HRS	76 PCS	0/1



Technical Data Sheet

3.0mm Round Type LED Lamps

204-10UYOC/S530-A3

Packing Quantity Specification

- 1.1000PCS/1Bag , 4Bags/1Box
- 2.10Boxes/1Carton

Label Form Specification



CPN: Customer's Production Number
 P/N : Production Number
 QTY: Packing Quantity
 CAT: Ranks
 HUE: Peak Wavelength
 REF: Reference
 LOT No: Lot Number
 MADE IN TAIWAN: Production Place

MADE IN TAIWAN

Notes

1. Above specification may be changed without notice. EVERLIGHT will reserve authority on material change for above specification.
2. When using this product, please observe the absolute maximum ratings and the instructions for using outlined in these specification sheets. EVERLIGHT assumes no responsibility for any damage resulting from use of the product which does not comply with the absolute maximum ratings and the instructions included in these specification sheets.
3. These specification sheets include materials protected under copyright of EVERLIGHT corporation. Please don't reproduce or cause anyone to reproduce them without EVERLIGHT's consent.

<p>EVERLIGHT ELECTRONICS CO., LTD. Office: No 25, Lane 76, Sec 3, Chung Yang Rd, Tucheng, Taipei 236, Taiwan, R.O.C</p>	<p>Tel: 886-2-2267-2000, 2267-9936 Fax: 886-2267-6244, 2267-6189, 2267-6306 http://www.everlight.com</p>
---	---