

# HIL CONNECTOR

## 3.3mm pitch/Crimp style Wire-to-wire connectors

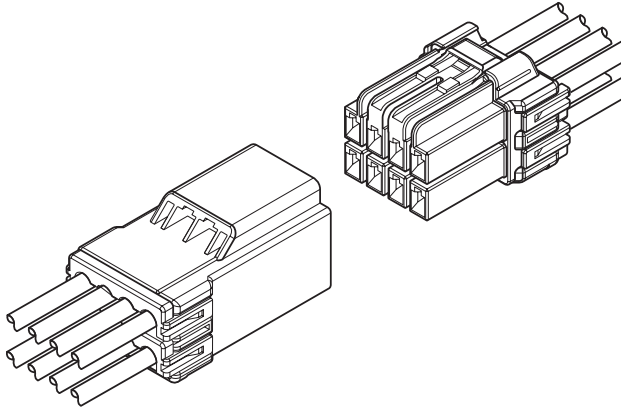

**This HIL connector is 3.3mm pitch wire-to-wire connector that has a mechanism to prevent an incomplete mating when mating connector.**

- **Inertia lock mechanism to prevent an incomplete mating**
- **Box-shaped contact to prevent the influence by external forces**
- **Polarizing key to prevent connector from mating with incorrect circuits**

### Assembly layout

<2, 3 circuits>

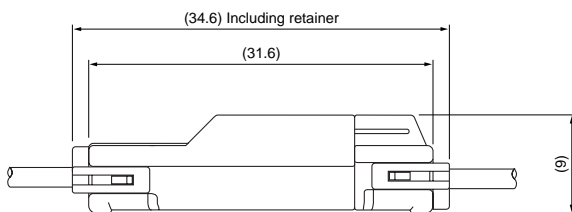

<4, 6, 8 circuits>

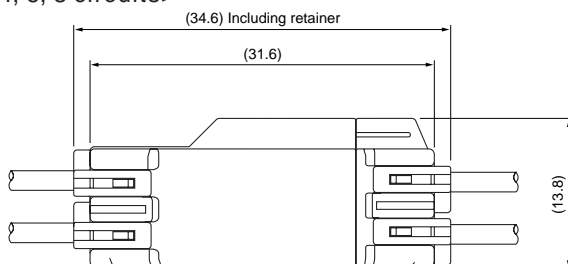

### Specifications

- Current rating: 5A AC, DC (2 circuits AWG #18)
  - Voltage rating: 300V AC, DC
  - Temperature range: -25°C to +85°C  
(including temperature rise in applying electrical current)
  - Contact resistance: Initial value/10m max.  
After environmental testing/20m max.
  - Insulation resistance: 1,000M min.
  - Withstanding voltage: 1,500V AC/minute
  - Applicable wire: Conductor size/01 type AWG #24 to #20  
/21 type AWG #22 to #18  
Insulation O.D./01 type 1.3 to 2.5mm  
/21 type 1.5 to 2.7mm  
(when using retainer for 21 type 1.5 to 2.5mm)
- \* Compliant with RoHS.  
\* Refer to "General Instruction and Notice when using Terminals and Connectors" at the end of this catalog.  
\* Contact JST for details.

Note: The current rating varies depending on the number of circuits and the wire size used in each connector. The table below lists the current rating as a function of the number of circuits and the wire size.

Current unit: A

Circuits	Wire size (AWG)			
	#18	#20	#22	#24
2	5	4	3	3
3	4	4	3	2
4	3	3	2	2
6	3	3	2	2
8	3	3	2	2

### List of combinations

Resin color (Plug/Receptacle)	Natural	Red	Blue
Polarizing key pattern	Polarizing key pattern 1	Polarizing key pattern 2	Polarizing key pattern 3
Plug Model No.	HILP-( )V-1-S	HILP-( )V-2-R	HILP-( )V-3-E
Receptacle Model No.	HILR-( )VF-1-S	HILR-( )VF-2-R	HILR-( )VF-3-E

# HIL CONNECTOR

## Contact

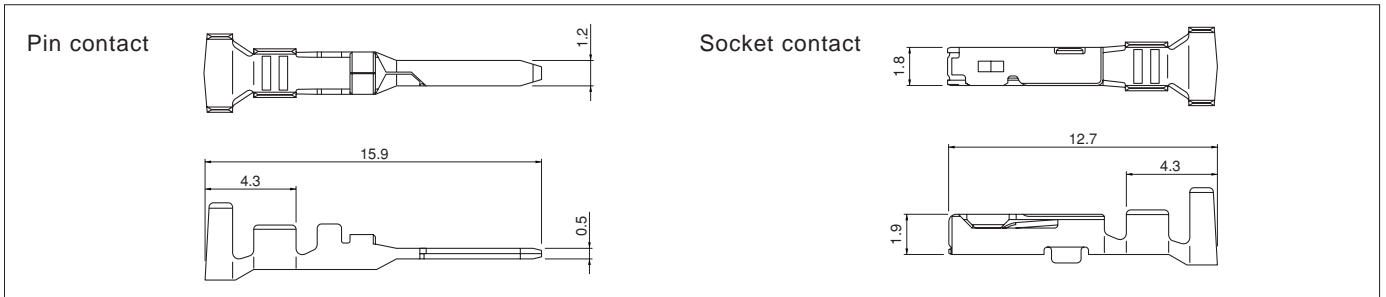

Model No.		Applicable wire		Insulation O.D. (mm)	Q'ty / reel
Pin contact	Socket contact	mm <sup>2</sup>	AWG #		
<b>SHIM-01T-P0.5</b>	<b>SHIF-01T-P0.5</b>	0.2~0.5	24~20	1.3~2.5	5,000
<b>SHIM-21T-P0.5</b>	<b>SHIF-21T-P0.5</b>	0.3~0.75	22~18	1.5~2.7	5,000

### Material and Finish

Copper alloy, tin-plated

### RoHS compliance

Note: Insulation O.D. is 1.5mm to 2.5mm when using retainer for 21 type barrel size contact.

Contact	Crimping machine	Applicator		
		Crimp applicator	Dies	Crimp applicator with dies
<b>SHIM-01T-P0.5</b>	AP-K2N	MKS-L	MK/SHIF/M-01-05	APLMK SHIF/M01-05
<b>SHIM-21T-P0.5</b>			MK/SHIF/M-21-05	APLMK SHIF/M21-05

Contact	Crimping machine	Applicator		
		Crimp applicator	Dies	Crimp applicator with dies
<b>SHIF-01T-P0.5</b>	AP-K2N	MKS-L	MK/SHIF/M-01-05	APLMK SHIF/M01-05
<b>SHIF-21T-P0.5</b>			MK/SHIF/M-21-05	APLMK SHIF/M21-05

## Contact position location numbers

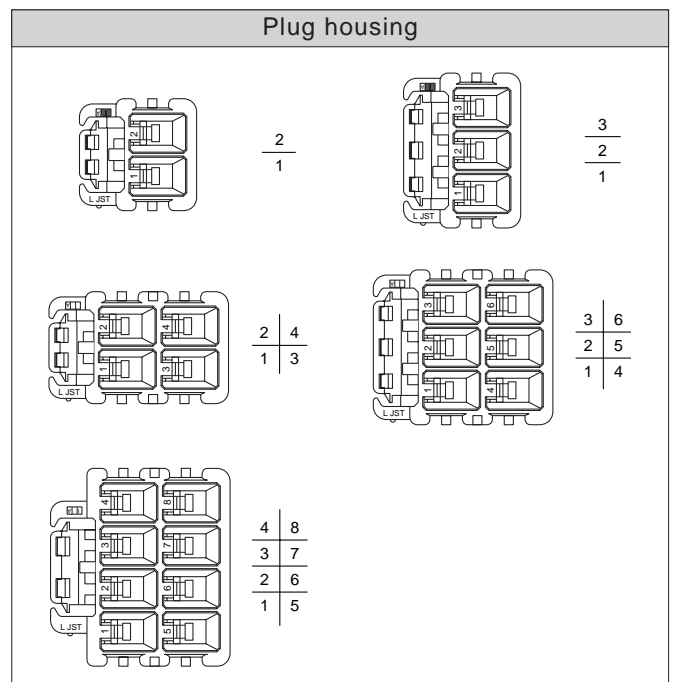
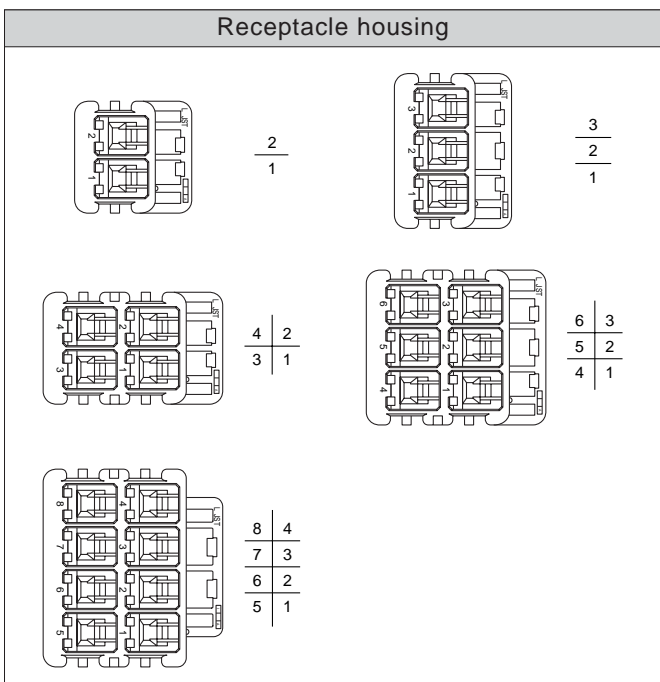
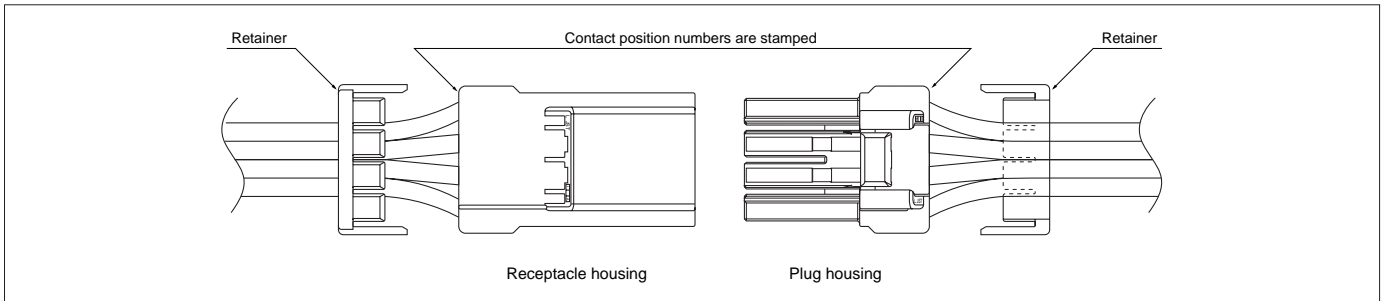

# HIL CONNECTOR

## Housing

Material: Housing...PA 66, UL94V-0, natural  
Retainer...Glass-filled PA 66, UL94V-0, natural

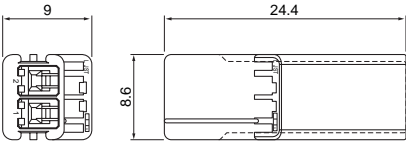
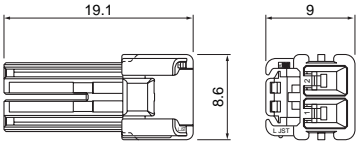
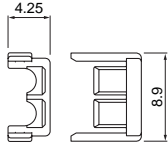
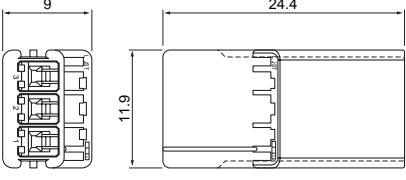
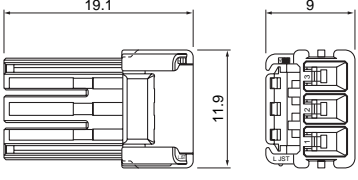
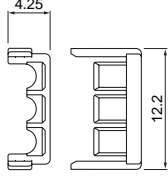
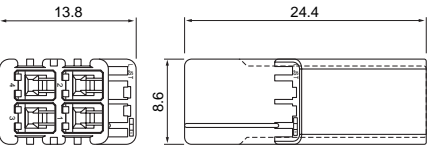
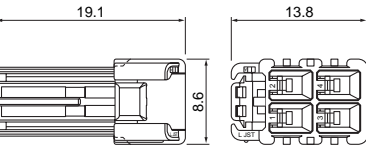
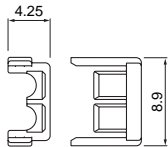
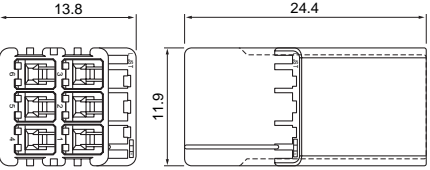
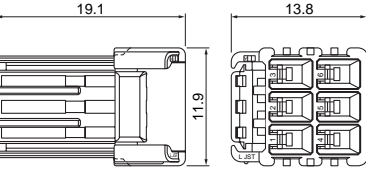
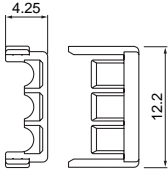
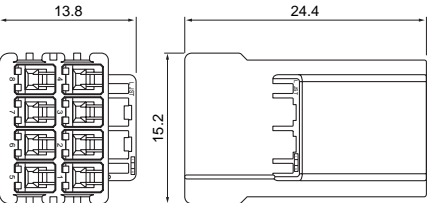
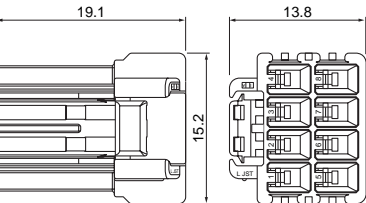
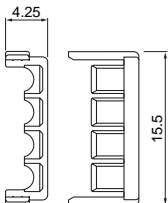
Circuits	Voltage rating	Current rating	Receptacle housing (for pin contact)		Plug housing (for socket contact)		Retainer	
2	300V	5A	<b>HILR-02VF-1-S</b> 	Q'ty / bag 1,000	<b>HILP-02V-1-S</b> 	Q'ty / bag 1,000	<b>HILS-02V</b> (commonly used for 2-circuit housing and 4-circuit housing) 	Q'ty / bag 1,000
3	300V	4A	<b>HILR-03VF-1-S</b> 	Q'ty / bag 1,000	<b>HILP-03V-1-S</b> 	Q'ty / bag 1,000	<b>HILS-03V</b> (commonly used for 3-circuit housing and 6-circuit housing) 	Q'ty / bag 1,000
4	300V	3A	<b>HILR-04VF-1-S</b> 	Q'ty / bag 1,000	<b>HILP-04V-1-S</b> 	Q'ty / bag 1,000	<b>HILS-02V</b> (commonly used for 2-circuit housing and 4-circuit housing) 	Q'ty / bag 1,000
6	300V	3A	<b>HILR-06VF-1-S</b> 	Q'ty / bag 500	<b>HILP-06V-1-S</b> 	Q'ty / bag 1,000	<b>HILS-03V</b> (commonly used for 3-circuit housing and 6-circuit housing) 	Q'ty / bag 1,000
8	300V	3A	<b>HILR-08VF-1-S</b> 	Q'ty / bag 500	<b>HILP-08V-1-S</b> 	Q'ty / bag 1,000	<b>HILS-04V</b> 	Q'ty / bag 1,000

RoHS compliance

Note: Current rating is for use with AWG #18 wire.