

TLP504A, -2

GaAs IRED & PHOTO-TRANSISTOR

(TLP504A)

PROGRAMMABLE CONTROLLERS

AC/DC-INPUT MODULE

SOLID STATE RELAY

The TOSHIBA TLP504A and TLP504A-2 consists of a photo-transistor optically coupled to a gallium arsenide infrared emitting diode.

The TLP504A offers two isolated channels in a eight lead plastic DIP package, while the TLP504A-2 provides four isolated channels in a sixteen plastic DIP package.

- Collector-Emitter Voltage : 55V (Min.)
- Current Transfer Ratio : 50% (Min.)
Rank GB : 100% (Min.)
- Isolation Voltage : 2500Vrms (Min.)
- UL Recognized : UL1577,
File No. E67349

PIN CONFIGURATIONS (TOP VIEW)

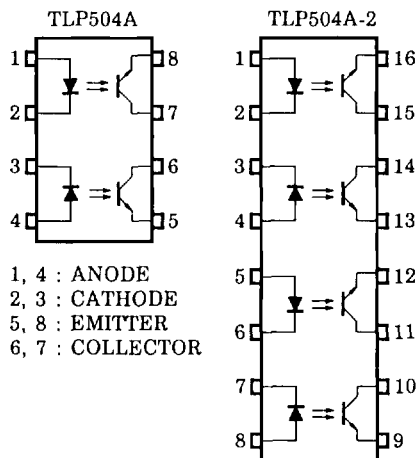

1, 4 : ANODE
2, 3 : CATHODE
5, 8 : EMITTER
6, 7 : COLLECTOR

1, 4, 5, 8 : ANODE
2, 3, 6, 7 : CATHODE
9, 12, 13, 16 : EMITTER
10, 11, 14, 15 : COLLECTOR

Unit in mm

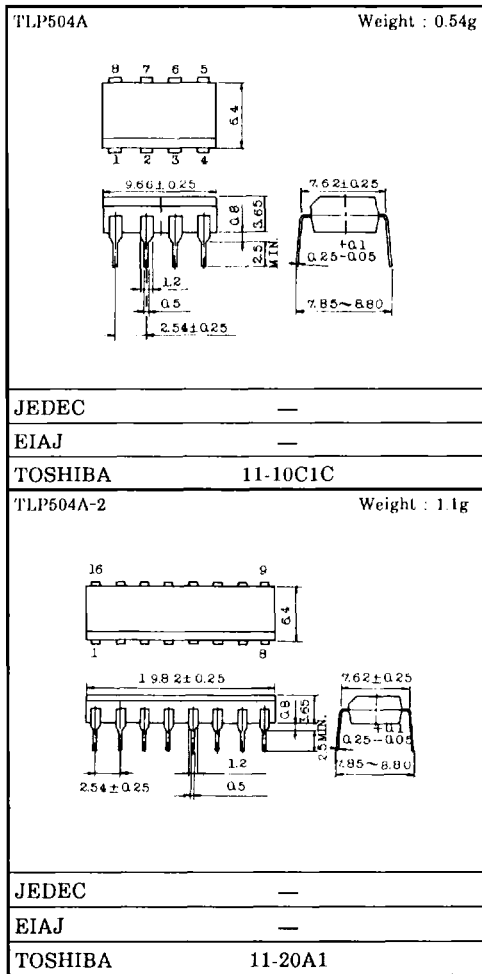

(TLP504A)

MAXIMUM RATINGS (Ta = 25°C)

CHARACTERISTIC		SYMBOL	RATING		UNIT
			TLP504A	TLP504A-2	
LED	Forward Current	I _F	60	50	mA
	Forward Current Derating	ΔI _F /°C	-0.7 (Ta ≥ 39°C)	-0.5 (Ta ≥ 25°C)	mA/°C
	Pulse Forward Current	I _{FP}	1 (100μs pulse, 100pps)		A
	Reverse Voltage	V _R	5		V
	Junction Temperature	T _j	125		°C
DETECTOR	Collector-Emitter Voltage	V _{CEO}	55		V
	Emitter-Collector Voltage	V _{ECO}	7		V
	Collector Current	I _C	50		mA
	Collector Power Dissipation (1 Circuit)	P _C	150	100	mW
	Collector Power Dissipation Derating (1 Circuit Ta ≥ 25°C)	ΔP _C /°C	-1.5	-1.0	mW/°C
	Junction Temperature	T _j	125		°C
	Storage Temperature Range	T _{stg}	-55~150		°C
Operating Temperature Range	T _{opr}	-55~100		°C	
Lead Soldering Temperature	T _{sol}	260 (10 s)		°C	
Total Package Power Dissipation	R _T	250	150	mW	
Total Package Power Dissipation Derating (Ta ≥ 25°C)	ΔP _T /°C	-2.5	-1.5	mW/°C	
Isolation Voltage	BV _S	2500 (AC, 1 min., RH ≤ 60%) (Note 1)		V _{rms}	

Note 1 : Device considered a two terminal device : LED side pins shorted together and DETECTOR side pins shorted together.

TLP504A, -2

(TLP504A)

INDIVIDUAL ELECTRICAL CHARACTERISTICS (Ta = 25°C)

CHARACTERISTIC		SYMBOL	TEST CONDITION	MIN.	TYP.	MAX.	UNIT
LED	Forward Voltage	V_F	$I_F = 10\text{mA}$	1.0	1.15	1.3	V
	Reverse Current	I_R	$V_R = 5\text{V}$	—	—	10	μA
	Capacitance	C_T	$V = 0, f = 1\text{MHz}$	—	30	—	pF
DETECTOR	Collector-Emitter Breakdown Voltage	$V_{(BR)CEO}$	$I_C = 0.5\text{mA}$	55	—	—	V
	Emitter-Collector Breakdown Voltage	$V_{(BR)ECO}$	$I_E = 0.1\text{mA}$	7	—	—	V
	Collector Dark Current	I_{CEO}	$V_{CE} = 24\text{V}$	—	10	100	nA
			$V_{CE} = 24\text{V}, T_a = 85^\circ\text{C}$	—	2	50	μA
Capacitance Collector to Emitter	C_{CE}	$V = 0, f = 1\text{MHz}$	—	10	—	pF	

COUPLED ELECTRICAL CHARACTERISTICS (Ta = 25°C)

CHARACTERISTIC	SYMBOL	TEST CONDITION	MIN.	TYP.	MAX.	UNIT
Current Transfer Ratio	I_C / I_F	$I_F = 5\text{mA}, V_{CE} = 5\text{V}$ Rank GB	50	—	600	%
			100	—	600	
Saturated CTR	$I_C / I_{F(sat)}$	$I_F = 1\text{mA}, V_{CE} = 0.4\text{V}$ Rank GB	—	60	—	%
			30	—	—	
Collector-Emitter Saturation Voltage	$V_{CE(sat)}$	$I_C = 2.4\text{mA}, I_F = 8\text{mA}$ $I_C = 0.2\text{mA}, I_F = 1\text{mA}$ Rank GB	—	—	0.4	V
			—	0.2	—	
			—	—	0.4	

ISOLATION CHARACTERISTICS (Ta = 25°C)

CHARACTERISTIC	SYMBOL	TEST CONDITION	MIN.	TYP.	MAX.	UNIT
Capacitance Input to Output	C_S	$V_S = 0, f = 1\text{MHz}$	—	0.8	—	pF
Isolation Resistance	R_S	$V_S = 500\text{V}$	5×10^{10}	10^{14}	—	Ω
Isolation Voltage	BV_S	AC, 1 minute	2500	—	—	V_{rms}
		AC, 1 second, in oil	—	5000	—	
		DC, 1 minute, in oil	—	5000	—	Vdc

(TLP504A)

SWITCHING CHARACTERISTICS (Ta = 25°C)

CHARACTERISTIC	SYMBOL	TEST CONDITION	MIN.	TYP.	MAX.	UNIT
Rise Time	t_r	$V_{CC} = 10V, I_C = 2mA$ $R_L = 100\Omega$	—	2	—	μs
Fall Time	t_f		—	3	—	
Turn-on Time	t_{on}		—	3	—	
Turn-off Time	t_{off}		—	3	—	
Turn-on Time	t_{ON}	$R_L = 1.9k\Omega$ (Fig.1) $V_{CC} = 5V, I_F = 16mA$	—	2	—	μs
Storage Time	t_s		—	15	—	
Turn-off Time	t_{OFF}		—	25	—	

Fig.1 Switching Time Test Circuit

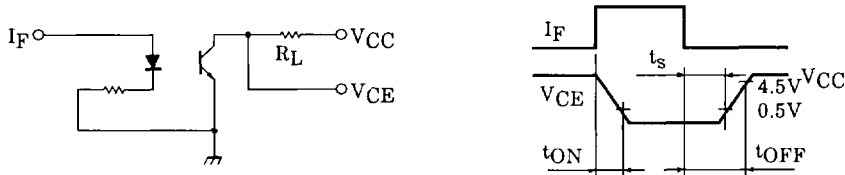

RECOMMENDED OPERATING CONDITIONS

CHARACTERISTIC	SYMBOL	MIN.	TYP.	MAX.	UNIT
Supply Voltage	V_{CC}	—	5	24	V
Forward Current	I_F	—	16	20	mA
Collector Current	I_C	—	1	10	mA
Operating Temperature	T_{opr}	-25	—	85	°C

TLP504A, -2

(TLP504A)

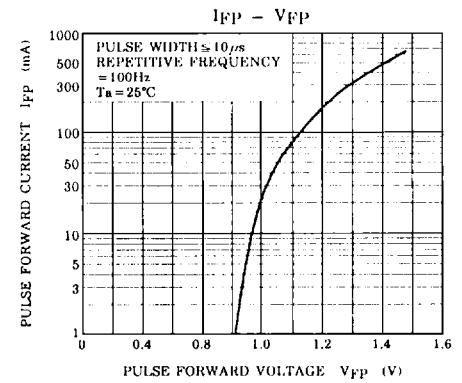
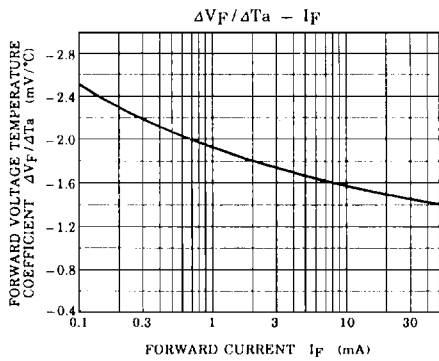
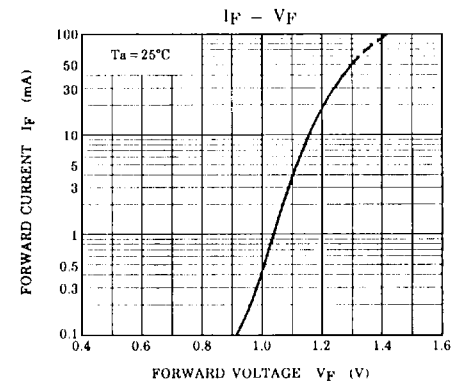
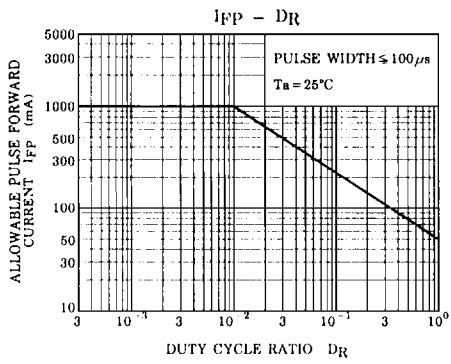
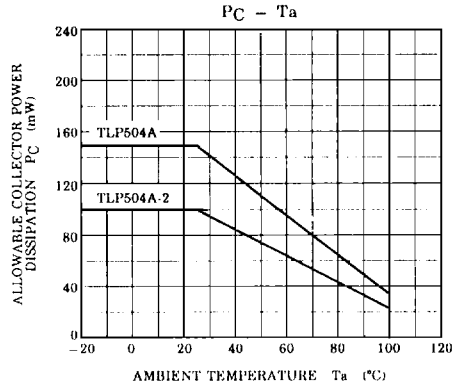
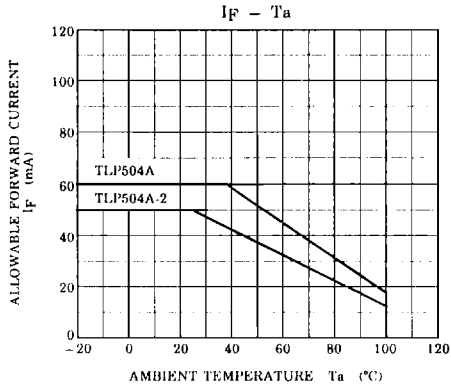

(TLP504A)

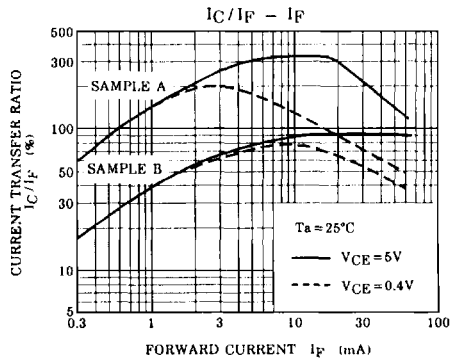
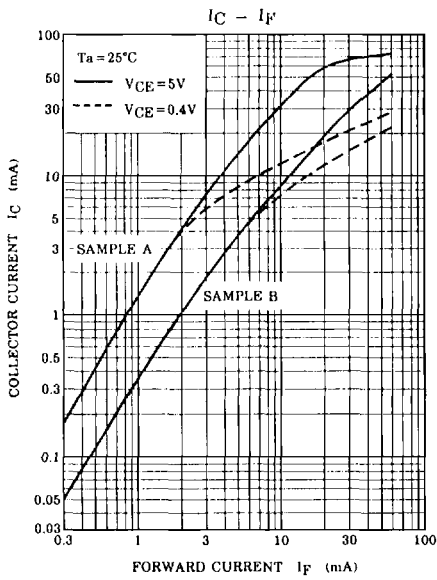
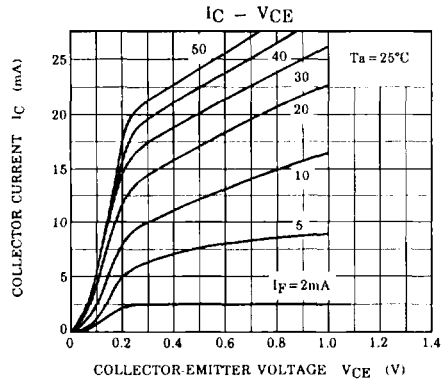
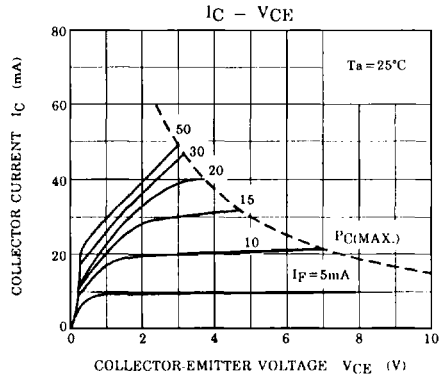
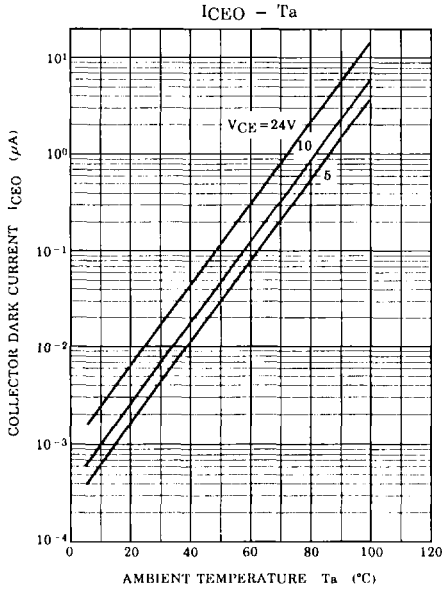

TLP504A, -2

(TLP504A)

