

LOW DROPOUT VOLTAGE REGULATOR

■ GENERAL DESCRIPTION

The NJM2857 is a low dropout voltage regulator. This product has Reverse Current Protection without external SBD. Advanced Bipolar technology achieves low noise, high ripple rejection and high supply voltage. 1.5A output current capacity, 4.7 μ F small decoupling capacitor, built-in noise bypass capacitor make the NJM2857 suitable for various applications.

■ PACKAGE OUTLINE

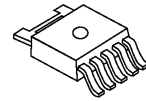

NJM2857DL3

■ FEATURES

- High Ripple Rejection 80dB typ. (f=1kHz, Vo=3V Version)
- Output Noise Voltage Vno=55 μ Vrms typ. (Vo=3V Version)
- Output capacitor with ceramic capacitor
- Output Current Io(max.)=1.5A
- High Precision Output Vo \pm 1.0%
- Low Dropout Voltage 0.20V typ. (Io=1A)
- ON/OFF Control
- Internal Reverse Current Protection
- Internal Thermal Overload Protection
- Internal Over Current Protection
- Bipolar Technology
- Package Outline TO-252-5

■ PIN CONFIGURATION

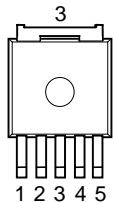

- 1.CONTROL
- 2.V_{IN}
- 3.GND
- 4.Vo
- 5.N.C.

NJM2857DL3

■ EQUIVALENT CIRCUIT

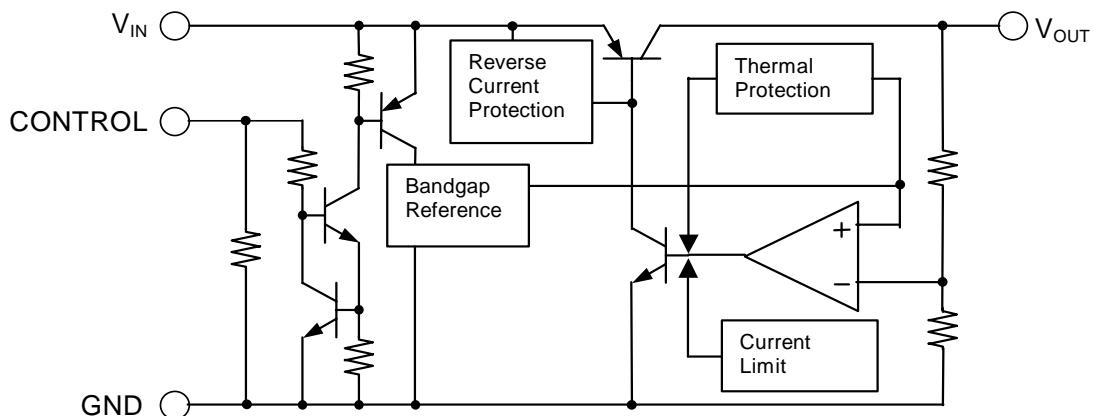

■ OUTPUT VOLTAGE

Device Name	V _{OUT}
NJM2857DL3-15	1.5V
NJM2857DL3-25	2.5V
NJM2857DL3-03	3.0V
NJM2857DL3-33	3.3V
NJM2857DL3-05	5.0V

Output voltage options available : 1.5 ~ 5.0V (0.1V step)

■ ABSOLUTE MAXIMUM RATINGS (Ta=25°C)

PARAMETER	SYMBOL	RATINGS	UNIT
Input Voltage	V _{IN}	+10	V
Control Voltage	V _{CONT}	+10	V
Output Terminal Voltage	V _{o,max}	V _o +1	V
Power Dissipation	P _D	1190(*1) 3125(*2)	mW
Operating Temperature	Topr	-40 ~ +85	°C
Storage Temperature	Tstg	-40 ~ +150	°C

(*1) : Mounted on glass epoxy board. (76.2x 114.3x1.6mm:EIA/JDEC standard size, 2Layers, copper area 100mm²)

(*2) : Mounted on glass epoxy board. (76.2x 114.3x1.6mm:EIA/JDEC standard size, 4Layers, copper area 100mm²)
(4Layers inner foil : 74.2 x 74.2mm Applying a thermal beer hall to a board based on JEDEC standard JESD51-5)

■ Operating voltage

V_{IN}=+2.6V(In case of V_o<2.4V) ~ +8V

■ ELECTRICAL CHARACTERISTICS

($V_{IN}=V_o+1V$ ($V_o<1.6V$: $V_{IN}=2.6V$), $C_{IN}=1.0\mu F$, $C_o=4.7\mu F$ ($1.7V<V_o\leq 2.4V$: $C_o=10\mu F$, $V_o\leq 1.7V$: $C_o=22\mu F$), $T_a=25^\circ C$)

PARAMETER	SYMBOL	TEST CONDITION	MIN.	TYP.	MAX.	UNIT	
Output Voltage	V_o	$I_o=30mA$	-1.0%	-	+1.0%	V	
Input Voltage	V_{IN}		-	-	8	V	
Quiescent Current	I_Q	$I_o=0mA$	-	500	750	μA	
Quiescent Current at Control OFF	$I_{Q(OFF)}$	$V_{CONT}=0V$	-	-	100	nA	
Output Current	I_o	$V_o\times 0.9V$	1500	2000	-	mA	
Line Regulation	$\Delta V_o/\Delta V_{IN}$	$V_{IN}=V_o+1V \sim V_o+6V$ ($V_o\leq 2V$), $V_{IN}=V_o+1V \sim +8V$ ($V_o>2V$), $I_o=30mA$	-	-	0.10	%/V	
Load Regulation	$\Delta V_o/\Delta I_o$	$I_o=0 \sim 1500mA$	-	-	0.003	%/mA	
Dropout Voltage(*1)	ΔV_{1-O}	$I_o=1000mA$	-	0.20	0.30	V	
Ripple Rejection(*2)	RR	$e_{in}=200mV_{rms}$, $f=1kHz$, $I_o=10mA$	$V_o=1.5V$	-	86	-	dB
			$V_o=2.5V$	-	82	-	
			$V_o=3.0V$	-	80	-	
			$V_o=3.3V$	-	79	-	
			$V_o=5.0V$	-	78	-	
Average Temperature Coefficient of Output Voltage	$\Delta V_o/\Delta T_a$	$T_a=0 \sim 85^\circ C$, $I_o=10mA$	-	± 50	-	ppm/ $^\circ C$	
Output Noise Voltage	V_{NO}	$f=10Hz \sim 80kHz$, $I_o=10mA$,	$V_o=1.5V$	-	26	-	μV_{rms}
			$V_o=2.5V$	-	41	-	
			$V_o=3.0V$	-	47	-	
			$V_o=3.3V$	-	51	-	
			$V_o=5.0V$	-	69	-	
Control Current	I_{CONT}	$V_{CONT}=1.6V$	-	3	12	μA	
Control Voltage for ON-state	$V_{CONT(ON)}$		1.6	-	-	V	
Control Voltage for OFF-state	$V_{CONT(OFF)}$		-	-	0.6	V	

(*1): The output voltage excludes under 2.4V

(*2): $V_o>2.0V$: $V_{IN}=V_o+1V$, $V_o\leq 2.0V$: $V_{IN}=3.0V$

The above specification is a common specification for all output voltages.

Therefore, it may be different from the individual specification for a specific output voltage.

■ POWER DISSIPATION vs. AMBIENT TEMPERATURE

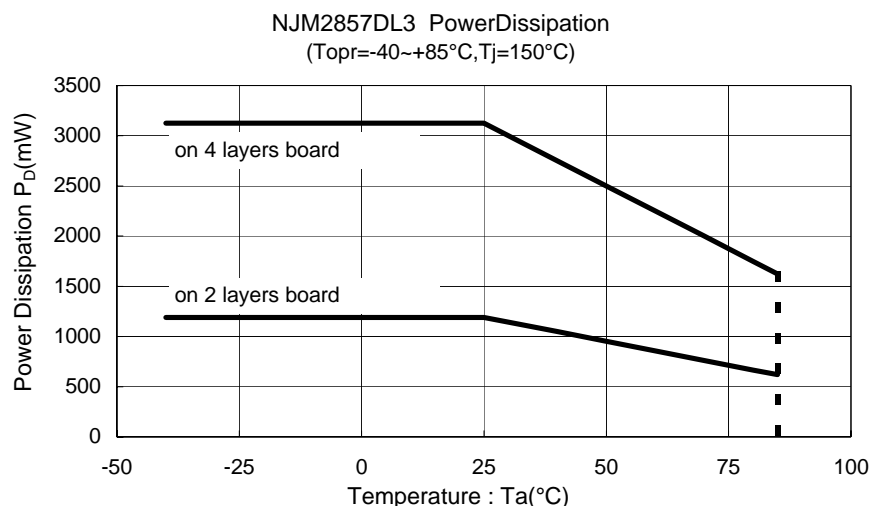

■ TEST CIRCUIT

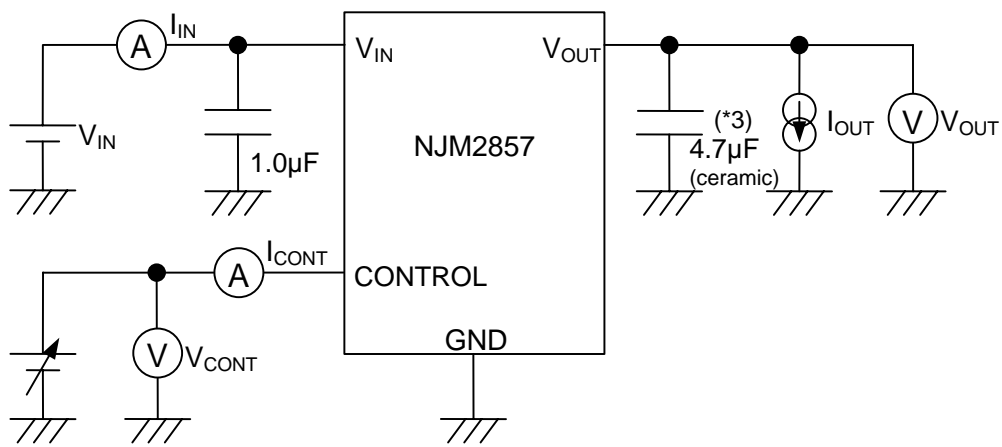

(*3) $1.7V < V_o \leq 2.4V$ version: $C_o = 10\mu F$ (ceramic)
 $V_o \leq 1.7V$ version: $C_o = 22\mu F$ (ceramic)

■ TYPICAL APPLICATIONS

① In the case where ON/OFF Control is not required:

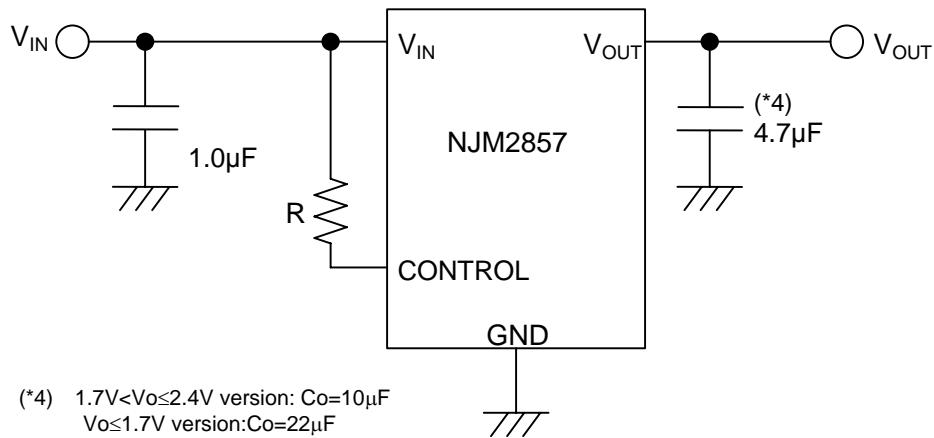

Connect control terminal to V_{IN} terminal

② In use of ON/OFF CONTROL:

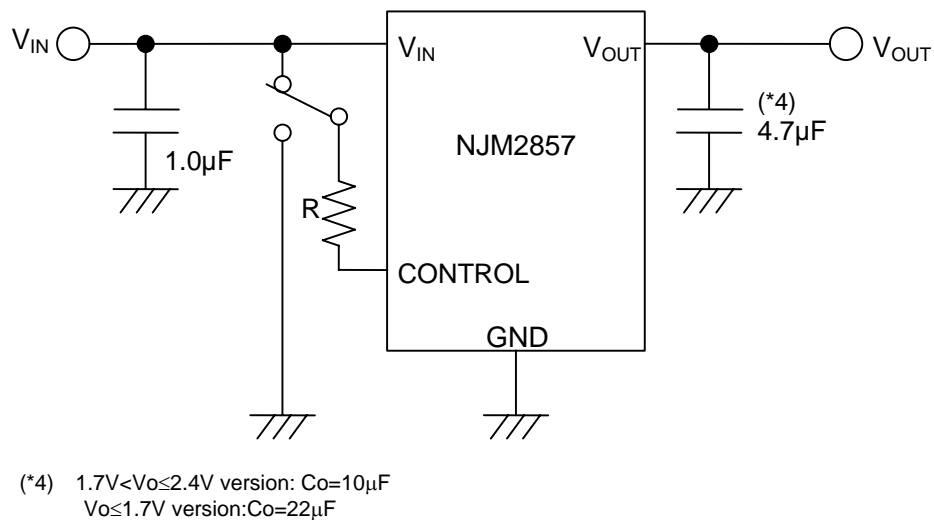

State of control terminal:

- "H" → output is enabled.
- "L" or "open" → output is disabled.

*In the case of using a resistance "R" between V_{IN} and control.

The current flow into the control terminal while the IC is ON state (I_{CONT}) can be reduced when a pull up resistance "R" is inserted between V_{IN} and the control terminal.

The minimum control voltage for ON state ($V_{CONT(ON)}$) is increased due to the voltage drop caused by I_{CONT} and the resistance "R". The I_{CONT} is temperature dependence as shown in the "Control Current vs. Temperature" characteristics. Therefore, the resistance "R" should be carefully selected to ensure the control voltage exceeds the $V_{CONT(ON)}$ over the required temperature range.

*Input Capacitance C_{IN}

Input Capacitance C_{IN} is required to prevent oscillation and reduce power supply ripple for applications with high power supply impedance or a long power supply line.

You should use the C_{IN} value of 0.1 μ F larger to avoid the problem.

C_{IN} should connect between GND and V_{IN} as shortest path as possible.

*Output Capacitance C_o

Output capacitor (C_o) will be required for a phase compensation of the internal error amplifier.

The capacitance and the equivalent series resistance (ESR) influence to stable operation of the regulator.

This product is designed to work with a low ESR capacitor (C_o). However use of recommended capacitance or larger value is effective for stable operation.

Use of a smaller C_o may cause excess output noise or oscillation of the regulator due to lack of the phase compensation.

Therefore use C_o with the recommended capacitance or larger value and connect between V_o terminal and GND terminal with shortest path. The recommended capacitance depends on the output voltage rank. Low voltage regulator requires larger value C_o . Thus, check the recommended capacitance for each output voltage rank.

Use of a larger C_o reduces output noise and ripple output, and also improves output transient response against rapid load change.

*Reverse Current Protection

A reverse current protection circuit is built-in to this product and prevents a current inflow from an Output terminal to the Input terminal when the input terminal voltage became lower than the output terminal voltage.

When a regulator is controlled by off ($V_{CONT} < 0.6V$), the reverse current protection circuit functions.

■ TYPICAL CHARACTERISTICS

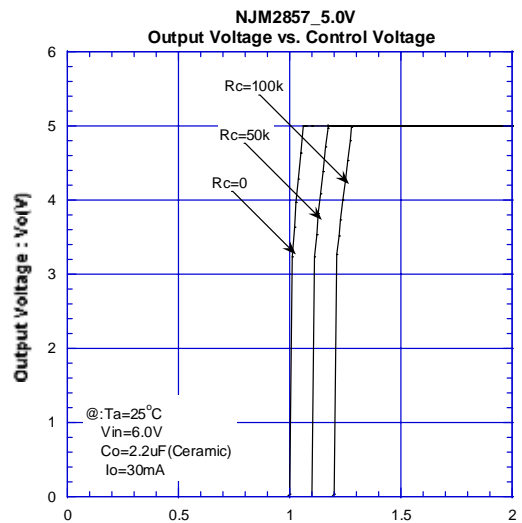
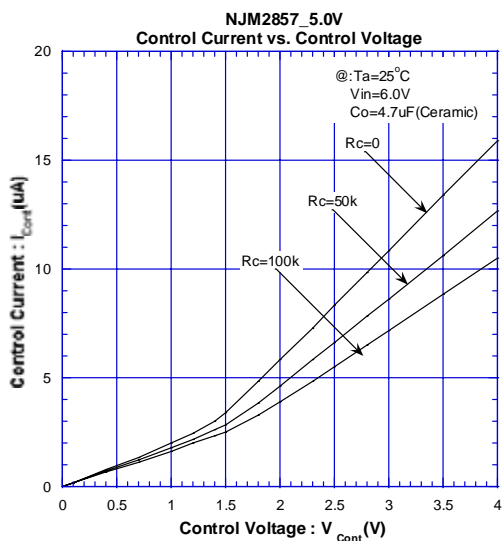
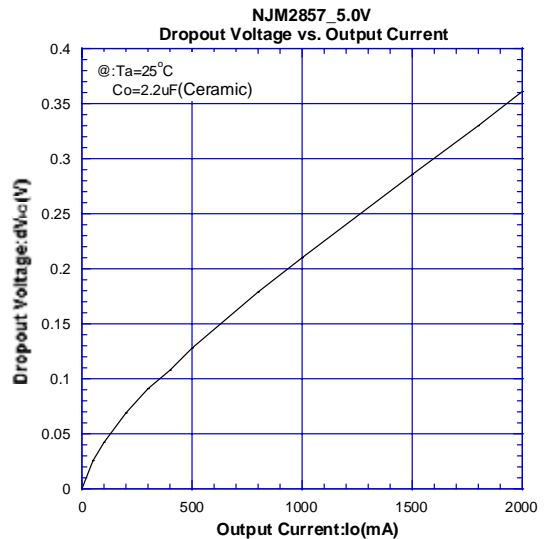
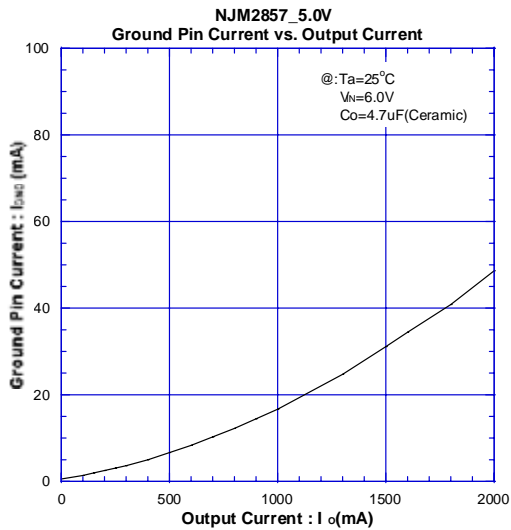
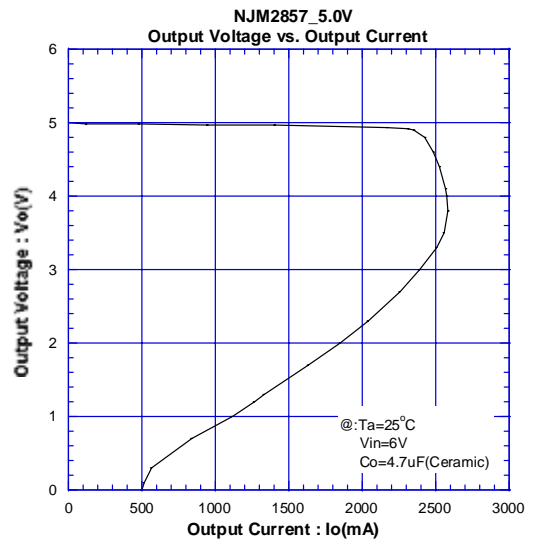
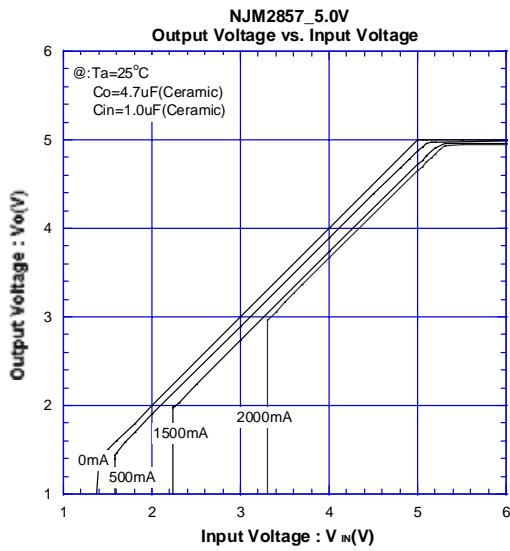

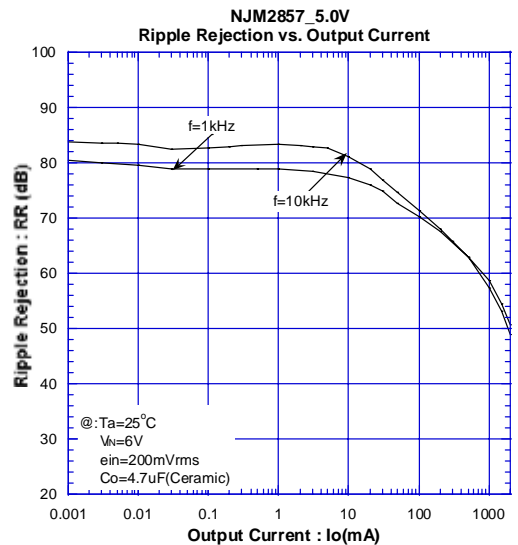
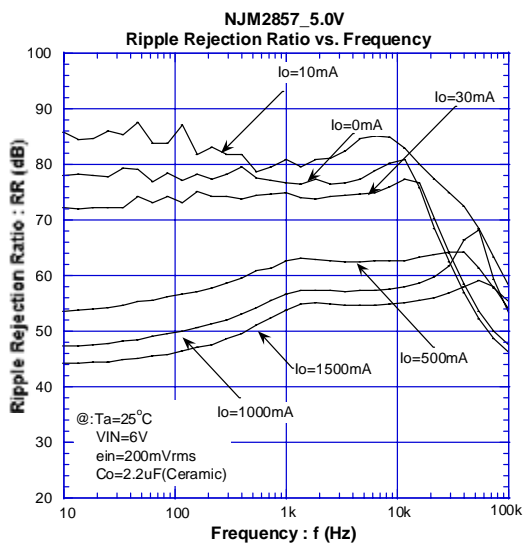
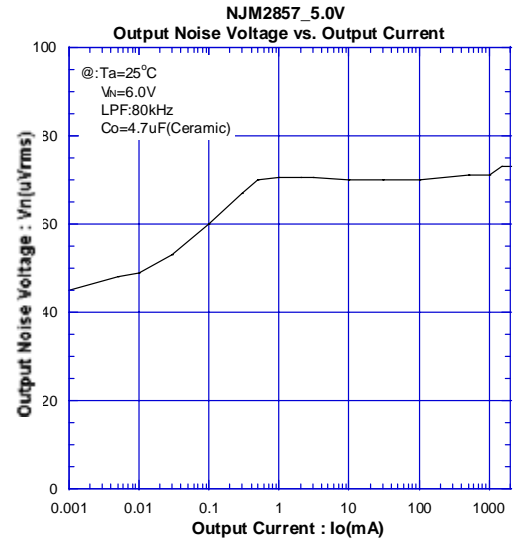
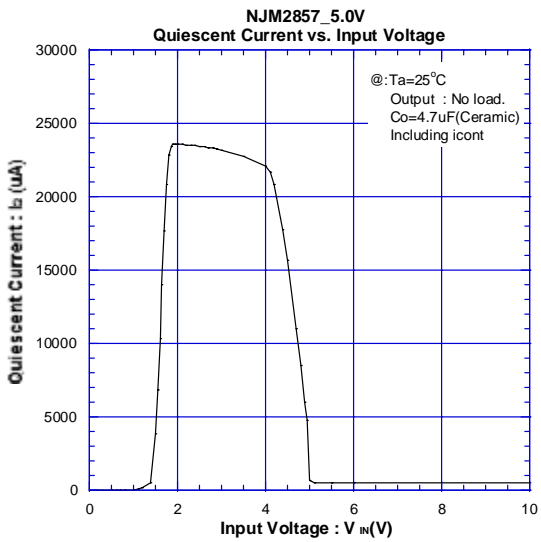
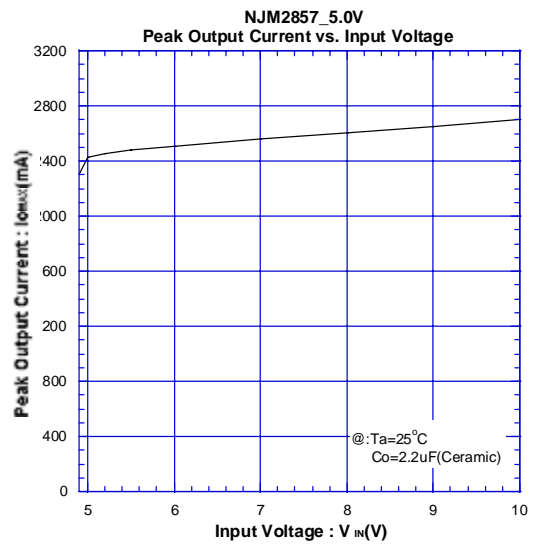
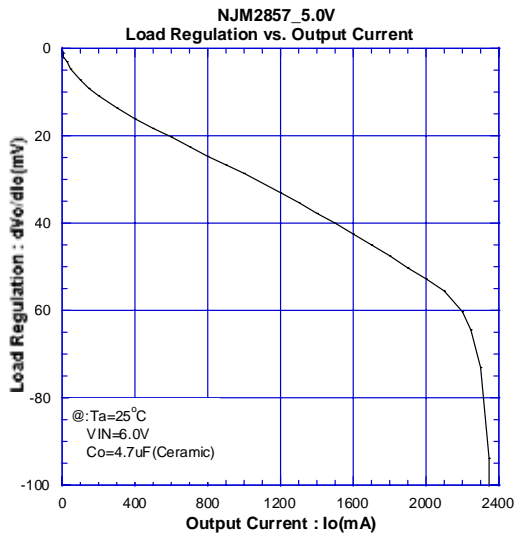

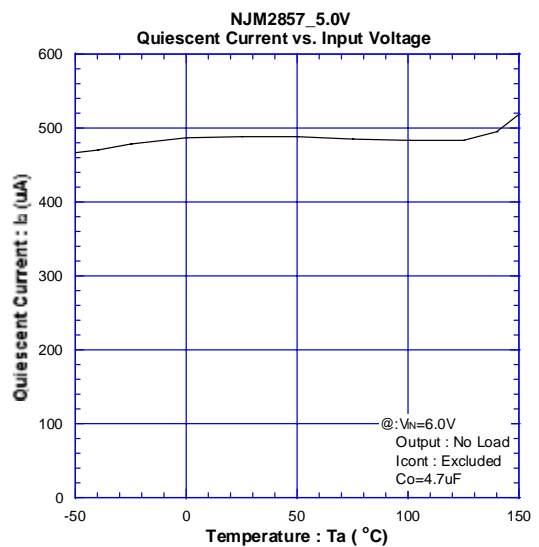
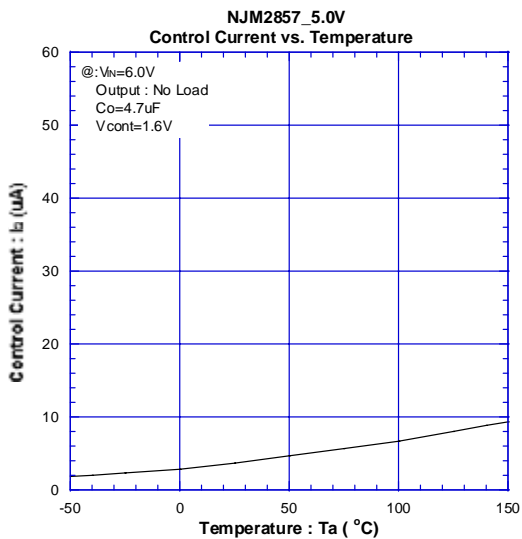
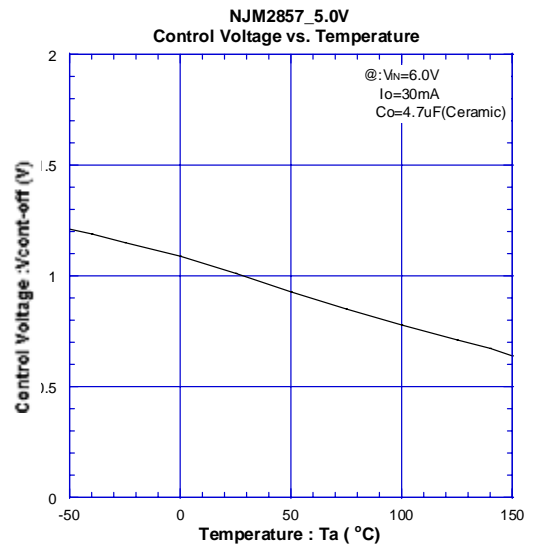
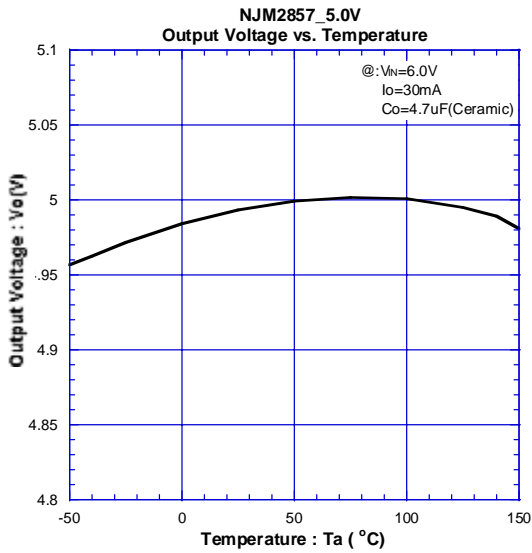
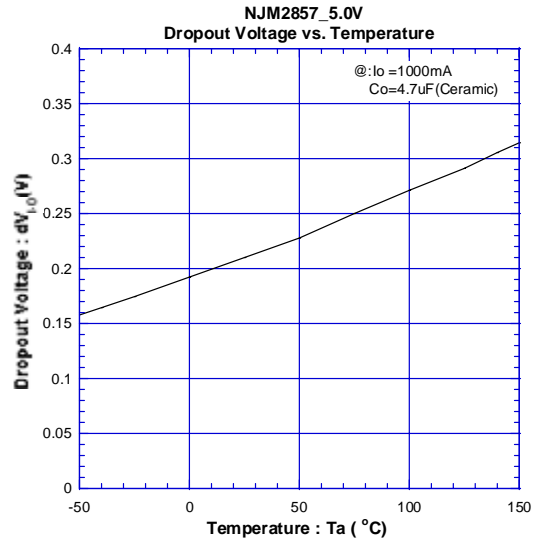
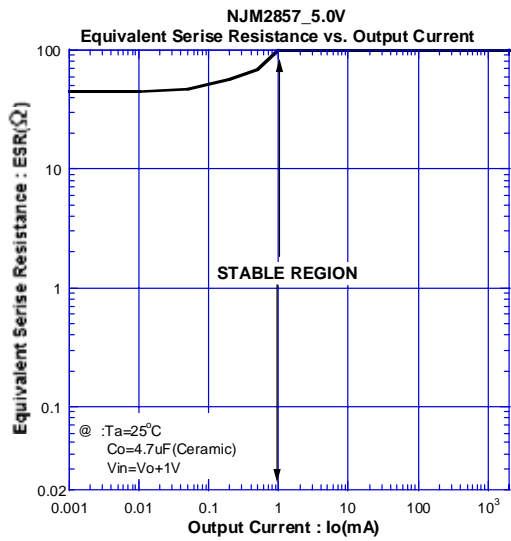

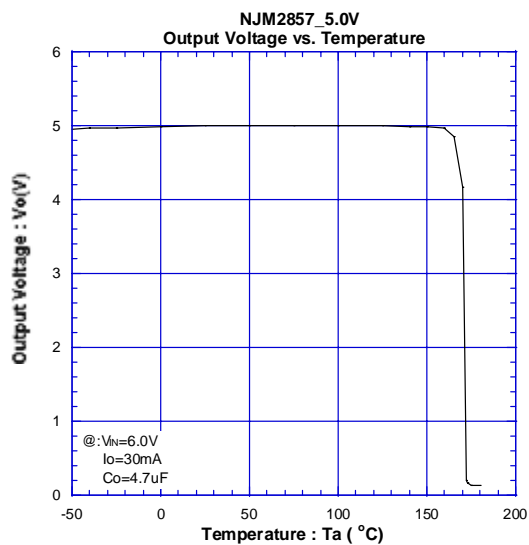
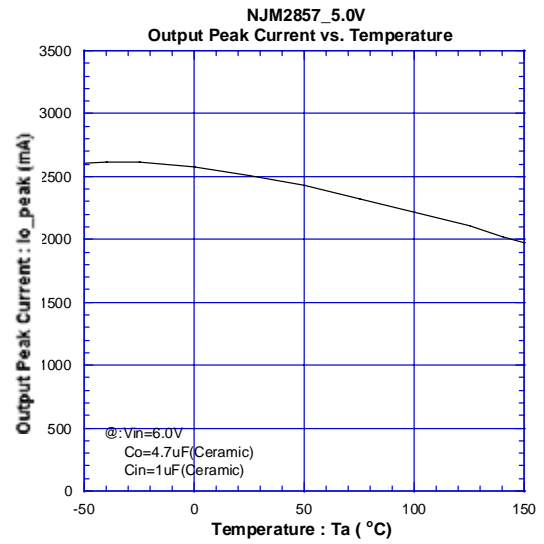
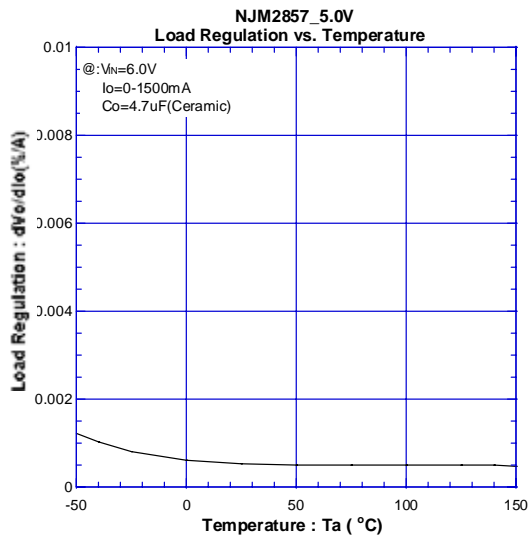
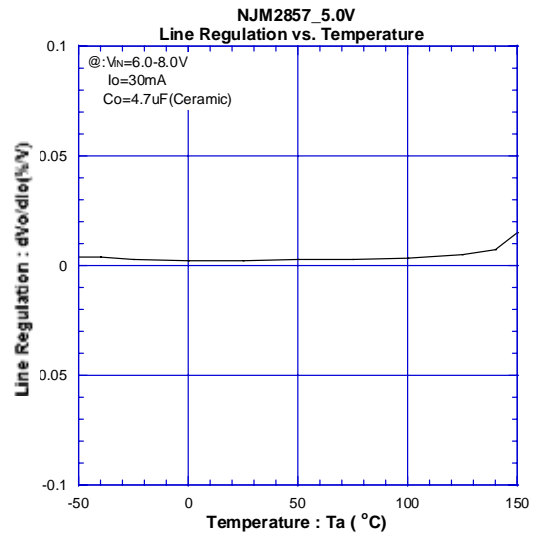
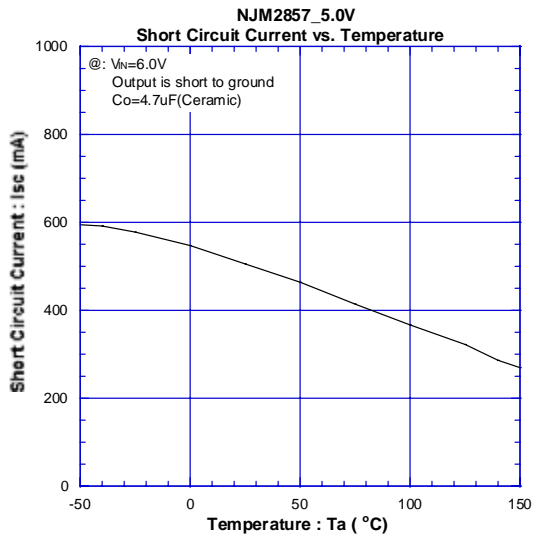

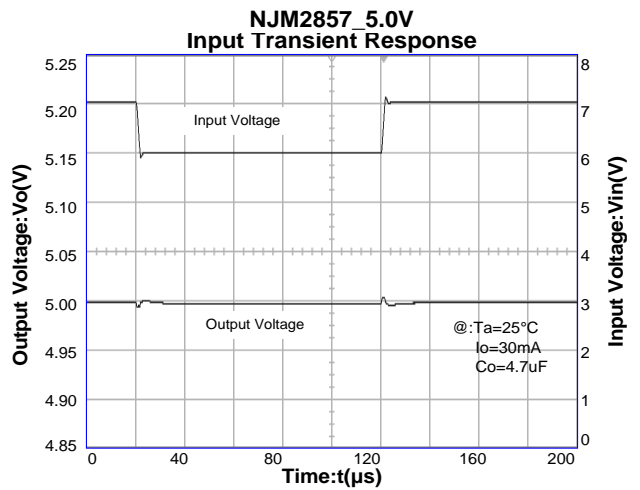
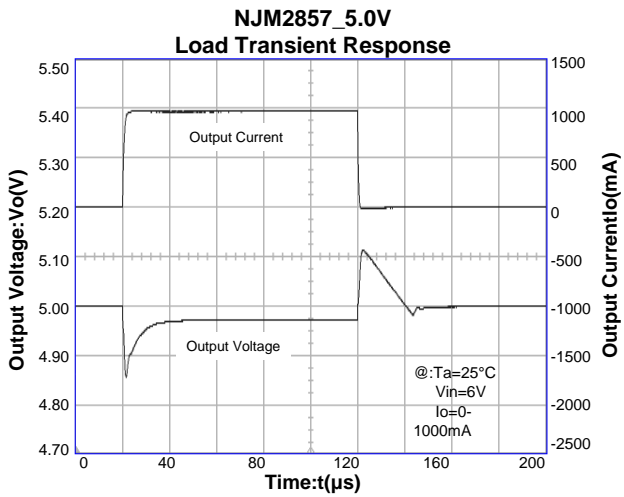
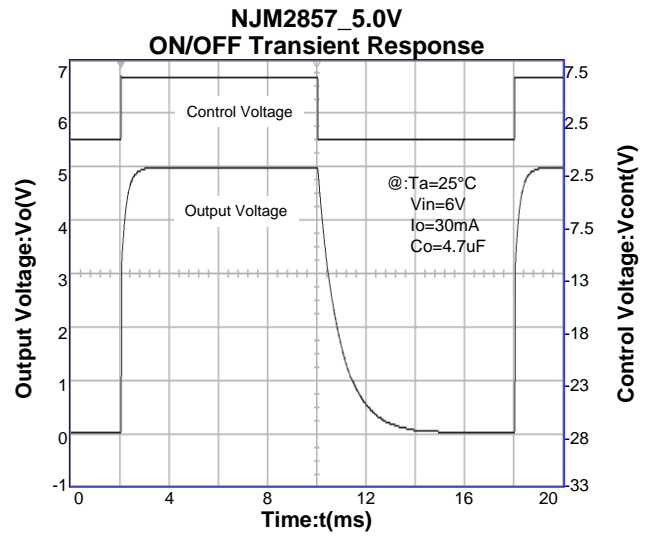
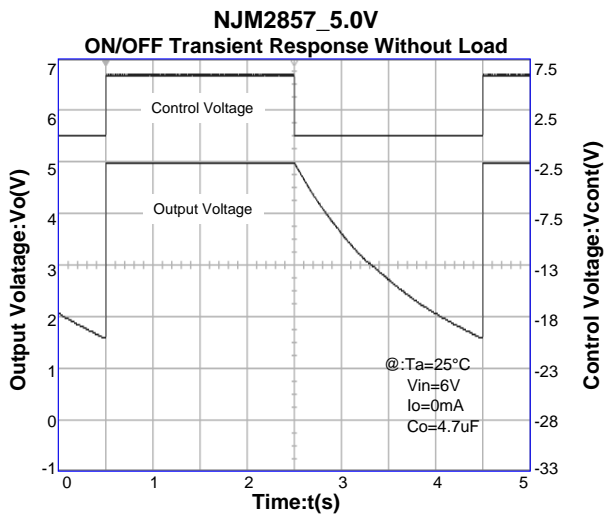

[CAUTION]

The specifications on this databook are only given for information, without any guarantee as regards either mistakes or omissions. The application circuits in this databook are described only to show representative usages of the product and not intended for the guarantee or permission of any right including the industrial rights.