

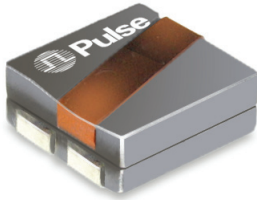





SMT POWER INDUCTORS

Flat Coils - PG0437NL Series



-  **Height:** 4.5mm Max
-  **Footprint:** 12.5mm x 11.0mm Max
-  **Peak Current Rating:** up to 39A
-  **Frequency Range:** 100kHz to 1MHz
-  **Ferrite Core:** No thermal ageing, very low core losses
-  **Patent Pending**

Electrical Specifications @ 25°C — Operating Temperature -40°C to +130°C¹

Part ⁸ Number	Inductance ² @I _{rated} (nH TYP)	I _{rated} ³ (A)	DCR (mΩ ±10%)	Inductance @0Adc (nH ±20%)	Saturation ⁴ Current I _{sat} (A TYP)		Heating ⁵ Current I _{dc} (A TYP)	Core Loss ⁶ Factor K ₂
					25°	100°		
PG0437.321NL	300	33	0.85	320	39	33	38	43.5
PG0437.401NL	362	28		400	31	28		54.3
PG0437.451NL	390	26		450	28	26		61.2
PG0437.601NL	530	18		600	21	18		81.5

Mechanical

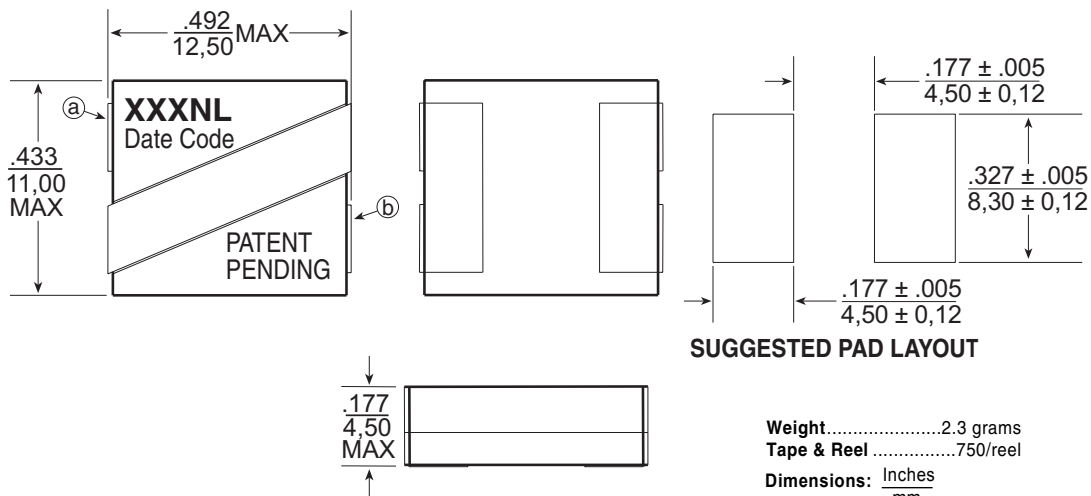

Unless otherwise specified, all tolerances are ± $\frac{.010}{0.25}$

TAPE & REEL LAYOUT

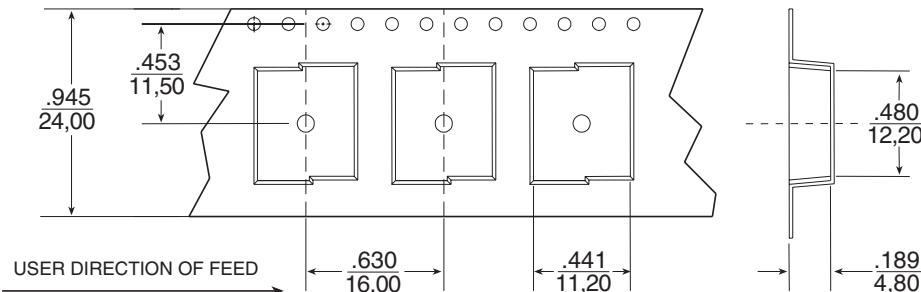

Schematic

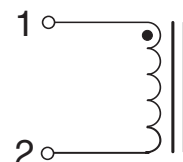

SMT POWER INDUCTORS

Flat Coils - PG0437NL Series



Notes from Tables

1. The temperature of the component (ambient plus temperature rise) must be within the specified operating temperature range.
2. Inductance at I_{rated} is a typical inductance value for the component taken at rated current.
3. The rated current listed is the lower of the saturation current @ 25°C, 100°C, or the heating current.
4. The saturation current, I_{SAT} , is the current at which the component inductance drops by 20% (typical) at an ambient temperature of 25°C and 100°C. This current is determined by placing the component in the specified ambient environment and applying a short duration pulse current (to eliminate self-heating effects) to the component.
5. The heating current, I_{DC} , is the DC current required to raise the component temperature by approximately 40°C. The heating current is determined by mounting the component on a typical PCB and applying current for 30 minutes. The temperature is measured by placing the thermocouple on top of the unit under test. Take note that the component's performance varies

depending on the system condition. It is suggested that the component be tested at the system level, to verify the temperature rise of the component during system operation.

6. Core loss approximation is based on published core data:

$$\text{Core Loss} = K1 * (f)^{1.12} * (K2\Delta I)^{2.17}$$

Where: Core Loss = in Watts

$$K1 = 8.74E-11$$

f = switching frequency in kHz

K1 & K2 = core loss factors

ΔI = delta I across the component in Ampere

K2 ΔI = one half of the peak to peak flux density across the component in Gauss

7. Unless otherwise specified, all testing is made at 100kHz, 0.1V_{AC}.
8. Optional Tape & Reel packaging can be ordered by adding a "T" suffix to the part number (i.e. PG0437.401NL becomes PG0437.401NLT). Pulse complies to industry standard tape and reel specification EIA481.

Typical Inductance vs DC Bias

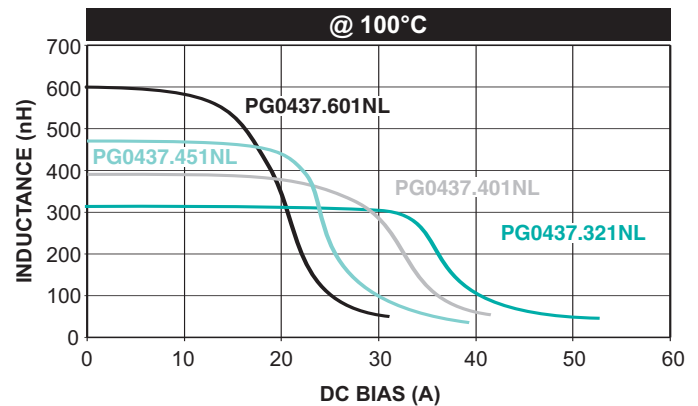
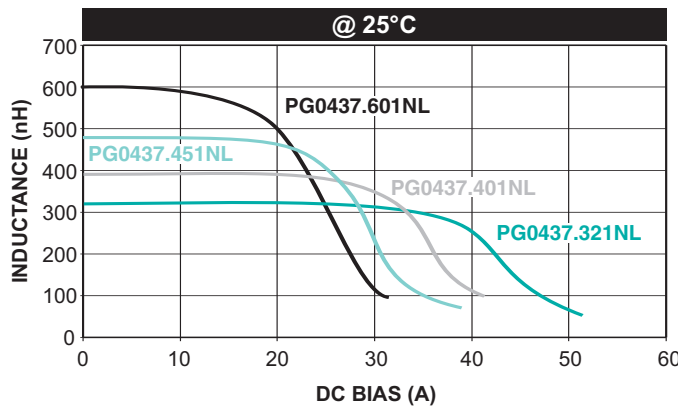

Typical Core Loss vs Peak Flux Density

