

## A 1V/1μA Easy-to-Use Resistor-Tuned Silicon Oscillator/Timer

### FEATURES

- ◆ Ultra Low Supply Current: 1μA at 25kHz
- ◆ Supply Voltage Operation: 0.9V to 1.8V
- ◆ Programmable Frequency Range:
  - $5.2\text{kHz} \leq \text{FOUT} \leq 90\text{kHz}$
- ◆ FOUT Period Drift: 0.021%/°C
- ◆ PWMOUT Duty Cycle Range: 12% to 90%
- ◆ Single Resistor Sets Output Frequency
- ◆ Output Driver Resistance: 160Ω

### APPLICATIONS

Portable and Battery-Powered Equipment  
 Low-Parts-Count Nanopower Oscillator  
 Compact Nanopower Replacement for Crystal and Ceramic Oscillators  
 Nanopower Pulse-width Modulation Control  
 Nanopower Pulse-position Modulation Control  
 Nanopower Clock Generation  
 Nanopower Sequential Timing

### DESCRIPTION

The TS3001 is a single-supply CMOS oscillator fully specified to operate at 1V while consuming a 1μA supply current at an output frequency of 25kHz. This oscillator is compact, easy-to-use, and versatile. Optimized for ultra-long life, battery-powered applications, the TS3001 joins Touchstone's TS3002 CMOS oscillator in the "NanoWatt Analog™" high-performance analog integrated circuits portfolio. The TS3001 can operate from single-supply voltages from 0.9V to 1.8V.

Requiring only a resistor to set the output frequency, the TS3001 represents a 66% reduction in pcb area and a factor-of-10 reduction in power consumption over other CMOS-based integrated circuit oscillators. When compared against industry-standard 555-timer-based products, the TS3001 offers up to 93% reduction in pcb area and four orders of magnitude lower power consumption.

The TS3001 is fully specified over the -40°C to +85°C temperature range and is available in a low-profile, 8-pin 2x2mm TDFN package with an exposed back-side paddle.

### TYPICAL APPLICATION CIRCUIT

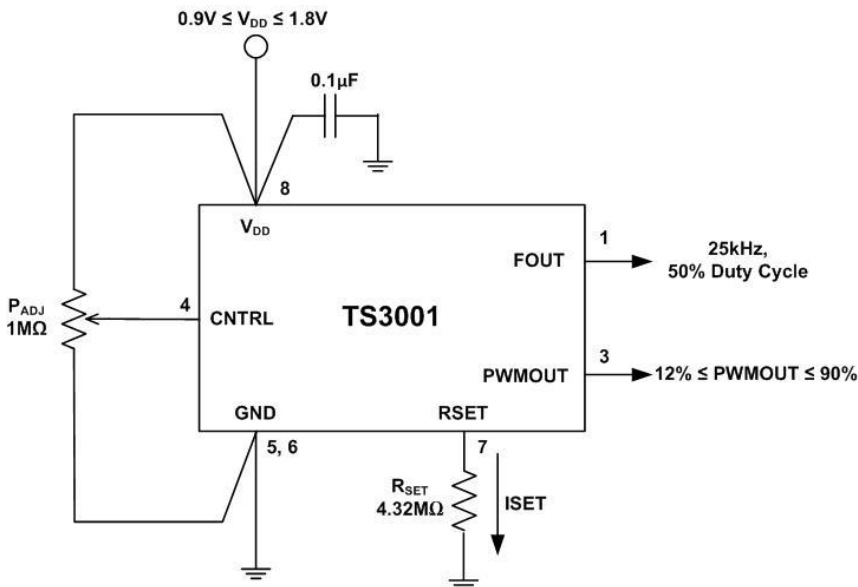

Table 1: FO<sub>UT</sub> vs R<sub>SET</sub>

R <sub>SET</sub> (MΩ)	FO <sub>UT</sub> (kHz)
1	110
2.49	44
4.32	25.5
6.81	16
9.76	11

The Touchstone Semiconductor logo and "NanoWatt Analog" are registered trademarks of Touchstone Semiconductor, Incorporated.

## ABSOLUTE MAXIMUM RATINGS

$V_{DD}$  to GND.....-0.3V to +2V  
 $V_{CNTRL}$  to GND.....-0.3V to +2V  
 RSET to GND.....-0.3V to +2V  
 FOUT, PWMOUT to GND.....-0.3V to +2V  
 Short Circuit Duration FOUT, PWMOUT to GND or  $V_{DD}$   
 ..... Continuous

Continuous Power Dissipation ( $T_A = +70^\circ\text{C}$ )  
 8-Pin TDFN (Derate at 23.8mW/ $^\circ\text{C}$  above  $+70^\circ\text{C}$ )..... 1951mW  
 Operating Temperature Range.....  $-40^\circ\text{C}$  to  $+85^\circ\text{C}$   
 Storage Temperature Range.....  $-65^\circ\text{C}$  to  $+150^\circ\text{C}$   
 Lead Temperature (Soldering, 10s).....  $+300^\circ\text{C}$

Electrical and thermal stresses beyond those listed under "Absolute Maximum Ratings" may cause permanent damage to the device. These are stress ratings only and functional operation of the device at these or any other condition beyond those indicated in the operational sections of the specifications is not implied. Exposure to any absolute maximum rating conditions for extended periods may affect device reliability and lifetime.

## PACKAGE/ORDERING INFORMATION

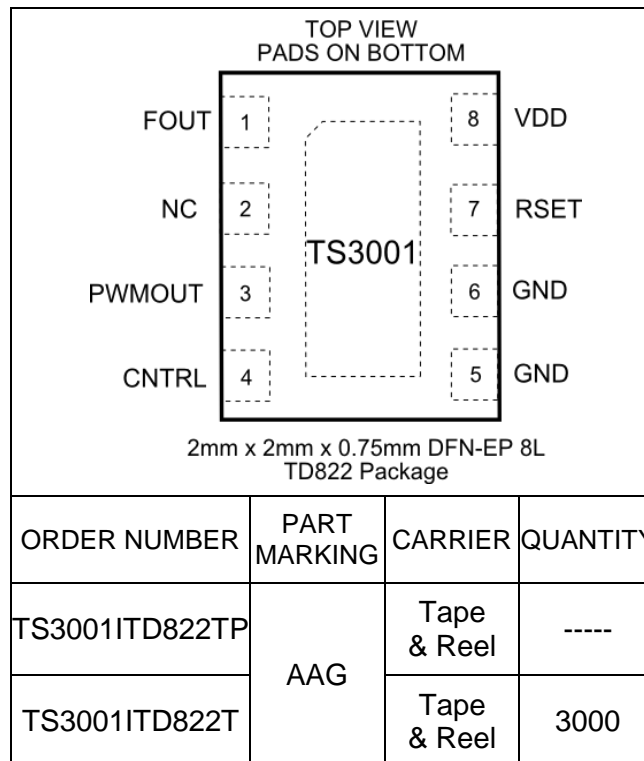

**Lead-free Program:** Touchstone Semiconductor supplies only lead-free packaging.

Consult Touchstone Semiconductor for products specified with wider operating temperature ranges.

## ELECTRICAL CHARACTERISTICS

$V_{DD} = 1V$ ,  $V_{CNTRL} = V_{DD}$ ,  $R_{SET} = 4.32M\Omega$ ,  $R_{LOAD(FOUT)} = \text{Open Circuit}$ ,  $C_{LOAD(FOUT)} = 0pF$ ,  $C_{LOAD(PWM)} = 0pF$  unless otherwise noted. Values are at  $T_A = 25^\circ C$  unless otherwise noted. See Note 1.

PARAMETER	SYMBOL	CONDITIONS	MIN	TYP	MAX	UNITS
Supply Voltage	$V_{DD}$		0.9	1	1.8	V
Supply Current	$I_{DD}$			1	1.5	$\mu A$
		$-40^\circ C \leq T_A \leq 85^\circ C$		2.1	2.8	
		$V_{CNTRL} = 0.15 \times V_{DD}$			3.7	
FOUT Period	$t_{FOUT}$		38.5		41.6	$\mu s$
		$-40^\circ C \leq T_A \leq 85^\circ C$	36.8		44.6	
FOUT Period Line Regulation	$\Delta t_{FOUT}/V$	$1V \leq V_{DD} \leq 1.8V$		1.8		%/V
FOUT Period Temperature Coefficient	$\Delta t_{FOUT}/\Delta T$			0.021		%/°C
PWMOUT Duty Cycle	DC(PWMOUT)	$V_{CNTRL} = 0.03 \times V_{DD}$	6	10.5	15	%
		$V_{CNTRL} = 0.15 \times V_{DD}$	45	49.8	54.2	
		$V_{CNTRL} = 0.27 \times V_{DD}$	84	91	98	
FOUT, PWMOUT Rise Time	$t_{RISE}$	See Note 2, $C_L = 15pF$		8.6		ns
FOUT, PWMOUT Fall Time	$t_{FALL}$	See Note 2, $C_L = 15pF$		7.9		ns
FOUT Jitter		See Note 3		0.08		%
RSET Pin Voltage	$V(RSET)$			0.3		V
CNTRL Output Current	$I_{CNTRL}$			25	45	nA
		$-40^\circ C \leq T_A \leq 85^\circ C$			100	
PWMOUT Enable	$V_{PWM\_EN}$	$(V_{DD} - V_{CNTRL})$ , $0.9V < V_{DD} < 1.8V$	375			mV
PWMOUT Disable	$V_{PWM\_DIS}$	$(V_{DD} - V_{CNTRL})$ , $0.9V < V_{DD} < 1.8V$			131	mV
High Level Output Voltage, FOUT and PWMOUT	$V_{DD} - V_{OH}$	$I_{OH} = 1mA$		160		mV
Low-level Output Voltage, FOUT and PWMOUT	$V_{OL}$	$I_{OL} = 1mA$		140		mV

**Note 1:** All devices are 100% production tested at  $T_A = +25^\circ C$  and are guaranteed by characterization for  $T_A = T_{MIN}$  to  $T_{MAX}$ , as specified.

**Note 2:** Output rise and fall times are measured between the 10% and 90% of the  $V_{DD}$  power-supply voltage levels. The specification is based on lab bench characterization and is not tested in production.

**Note 3:** Timing jitter is the ratio of the peak-to-peak variation of the period to the mean of the period. The specification is based on lab bench characterization and is not tested in production.

## TYPICAL PERFORMANCE CHARACTERISTICS

$V_{DD} = 1V$ ,  $V_{CNTRL} = V_{DD}$ ,  $R_{SET} = 4.32M\Omega$ ,  $R_{LOAD(FOUT)} = \text{Open Circuit}$ ,  $C_{LOAD(FOUT)} = 5pF$ , unless otherwise noted. Values are at  $T_A = 25^\circ C$  unless otherwise noted.

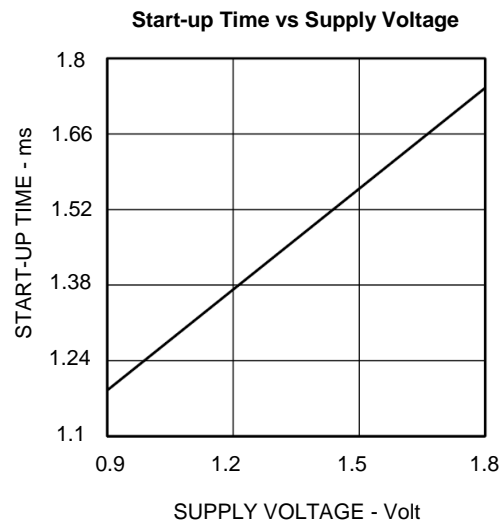
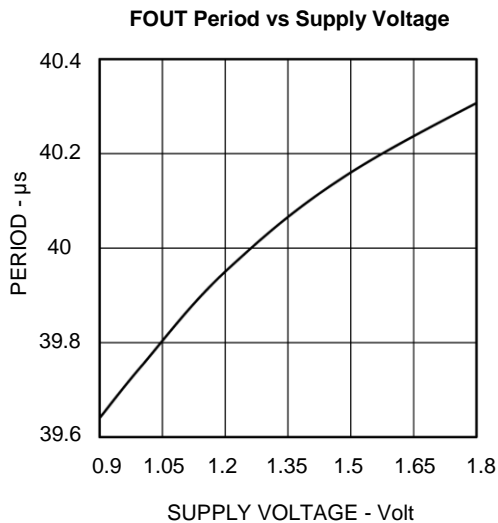
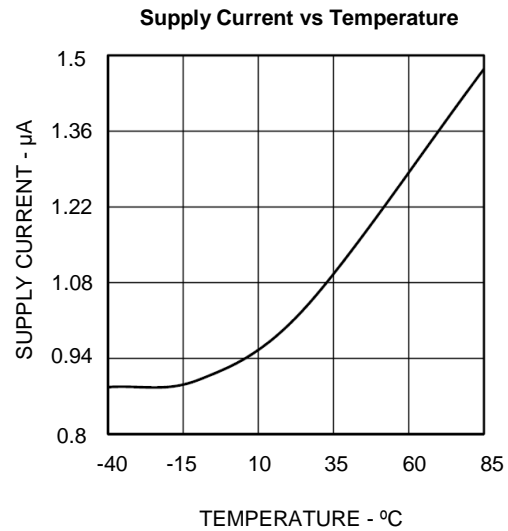
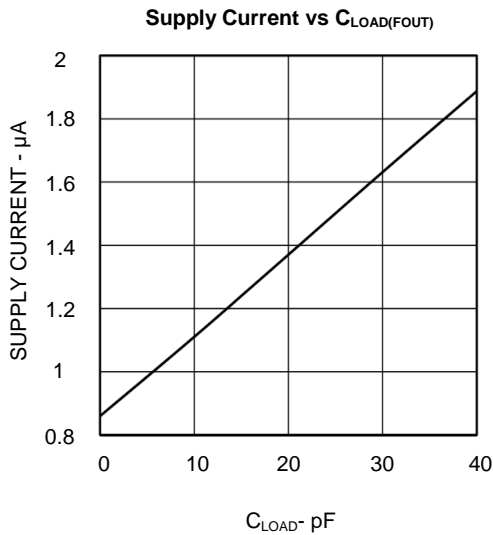
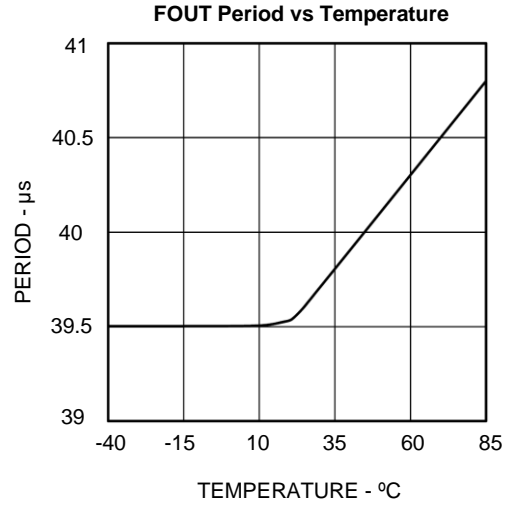
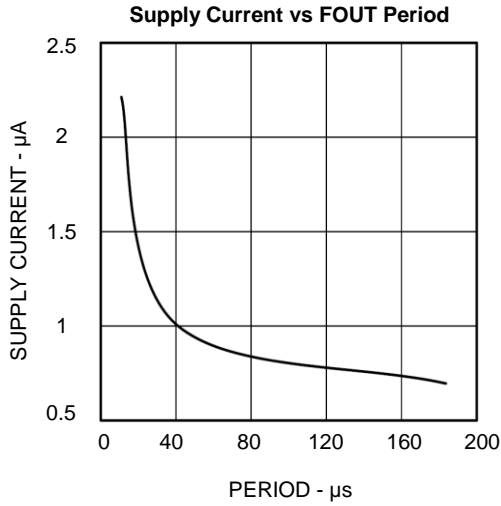

## TYPICAL PERFORMANCE CHARACTERISTICS

$V_{DD} = 1V$ ,  $V_{CNTRL} = V_{DD}$ ,  $R_{SET} = 4.32M\Omega$ ,  $R_{LOAD(FOUT)} = \text{Open Circuit}$ ,  $C_{LOAD(FOUT)} = 5pF$ , unless otherwise noted. Values are at  $T_A = 25^\circ C$  unless otherwise noted.

Period vs  $R_{SET}$

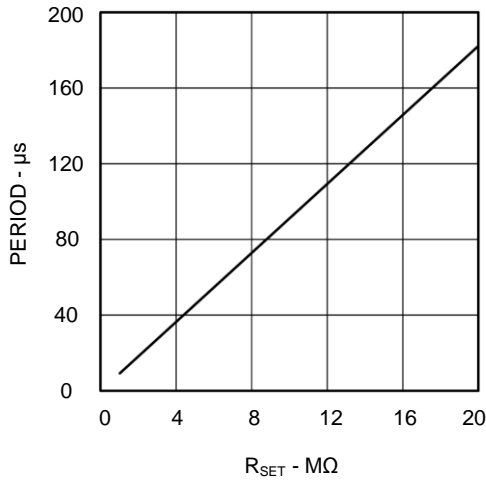

Supply Current Distribution

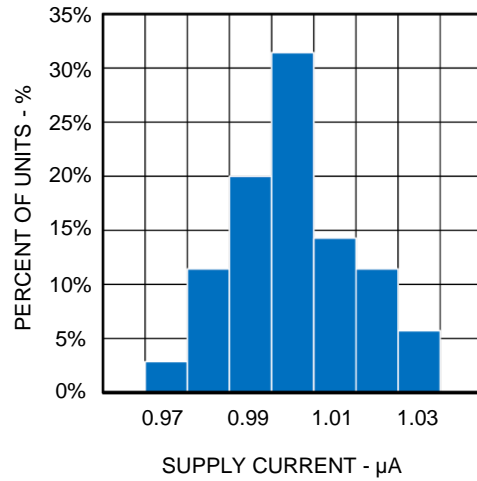

FOUT Transient Response  
 $V_{DD} = 1V$ ,  $C_{LOAD} = 47pF$

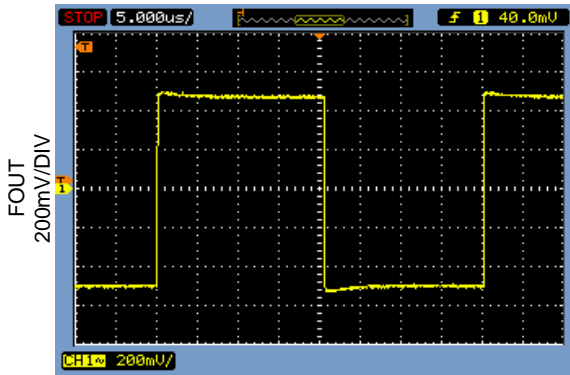

5μs/DIV

FOUT Transient Response  
 $V_{DD} = 1.5V$ ,  $C_{LOAD} = 47pF$

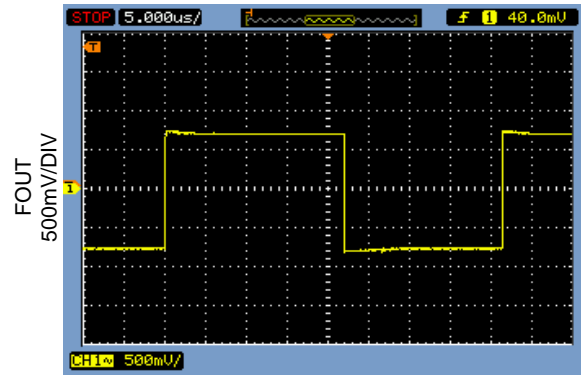

5μs/DIV

FOUT and PWMOUT Transient Response  
 $V_{DD} = 1V$ ,  $V_{CNTRL} = 0.035 \times V_{DD}$ ,  $C_{LOAD} = 22pF$

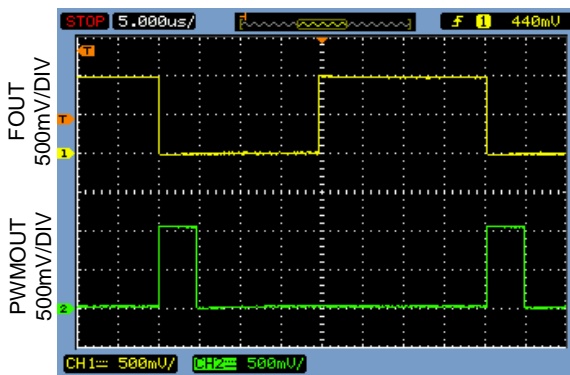

5μs/DIV

FOUT and PWMOUT Transient Response  
 $V_{DD} = 1.5V$ ,  $V_{CNTRL} = 0.035 \times V_{DD}$ ,  $C_{LOAD} = 22pF$

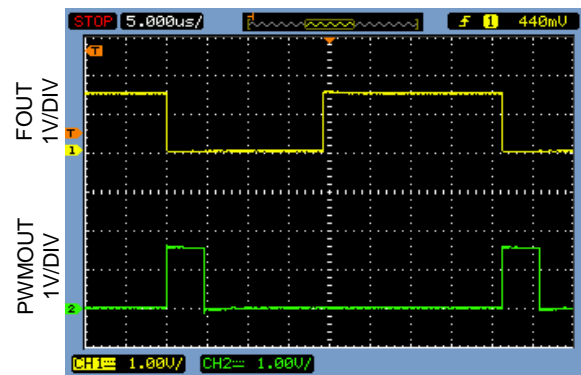

5μs/DIV

## PIN FUNCTIONS

PIN	NAME	FUNCTION
1	FOUT	Fixed Duty Cycle Output. A push-pull output stage with an output resistance of 160Ω, the FOUT pin swings from GND to V <sub>DD</sub> . For lowest power operation, capacitive loads should be minimized and resistive loads should be maximized.
2	NC	No Connection.
3	PWMOUT	Pulse-width Modulated Output. A push-pull output stage with an output resistance of 160Ω, the PWMOUT pin is wired anti-phase with respect to FOUT and swings from GND to V <sub>DD</sub> . For lowest power operation, capacitive loads should be minimized and resistive loads should be maximized.
4	CNTRL	PWMOUT Enable and Duty Cycle Control Input. An analog input pin, the V <sub>CNTRL</sub> pin voltage enables the TS3001's PWM engine and controls the duty cycle at PWMOUT from 12% (V <sub>CNTRL</sub> = 0.03 x V <sub>DD</sub> ) to 90% (V <sub>CNTRL</sub> = 0.27 x V <sub>DD</sub> ). Enabling the PWM engine increases the TS3001's nominal operating supply current. To disable the TS3001's PWM engine, CNTRL shall be connected to V <sub>DD</sub> .
5,6	GND	Ground – Connect this pin to the system's analog ground plane.
7	RSET	FOUT Programming Resistor Input. A 4.32MΩ resistor connected from this pin to GND sets the TS3001's internal oscillator's output period to 40μs (25kHz). For optimal performance, the composition of the RSET resistor shall be consistent with tolerances of 1% or lower. The RSET pin voltage is 0.3V at a 1V supply.
8	VDD	Power Supply Voltage Input. While the TS3001 is fully specified at 1V, the supply voltage range is 0.9V ≤ V <sub>DD</sub> ≤ 1.8V. It is always considered good engineering practice to bypass the V <sub>DD</sub> pin with a 0.1μF ceramic decoupling capacitor in close proximity to the TS3001.
EP	-----	Exposed paddle is electrically connected to GND.

## BLOCK DIAGRAM

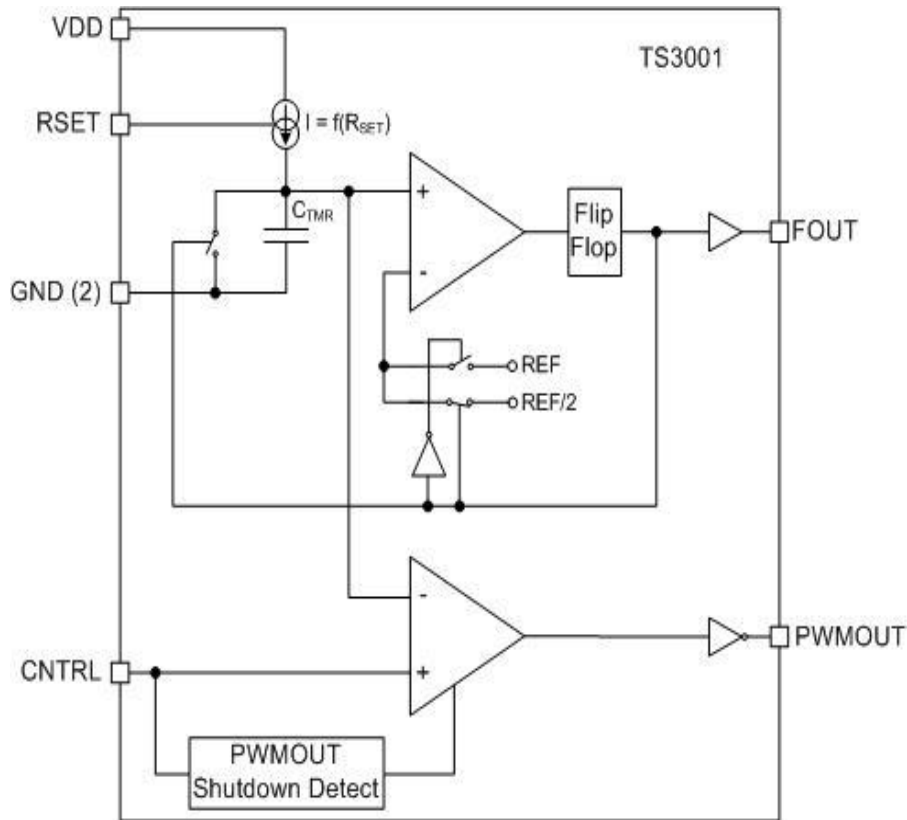

## THEORY OF OPERATION

The TS3001 is a user-programmable oscillator where the period of the square wave at its FOUT terminal is generated by an external resistor. The output frequency is given by:

$$F_{OUT} \text{ (kHz)} = \frac{1}{t_{FOUT} \text{ (\mu s)}} = \frac{1E6}{k \times R_{SET} \text{ (M}\Omega\text{)}}$$

**Table 1: FOUT vs RSET**

R <sub>SET</sub> (MΩ)	FOUT (kHz)
1	110
2.49	44
4.32	25.5
6.81	16
9.76	11

where the scalar k is approximately 9.09E3. With an R<sub>SET</sub> = 4.32MΩ, the output frequency is approximately 25kHz with a 50% duty cycle. As design aids, Tables 1 lists TS3001's typical FOUT for various standard values for R<sub>SET</sub>.

The TS3001 also provides a separate PWM output signal at its PWMOUT terminal that is anti-phase with respect to FOUT. In addition, applying a voltage at the CNTRL both enables the TS3001's internal PWM engine as well as adjusting the duty cycle from 12% to 90%. A dc control voltage equal to 0.03 x VDD applied to the CNTRL pin enables the PWM engine to set the duty cycle to 12%. A dc control voltage equal to 0.27 x VDD increases the duty cycle to 90% and connecting CNTRL to VDD disables the PWM engine altogether. Configured for nominal operation (PWM engine OFF), the supply current of the TS3001 is 1μA; enabling the PWM engine increases the TS3001 operating supply current as shown in the electrical specification table.

## APPLICATIONS INFORMATION

### Minimizing Power Consumption

To keep the TS3001's power consumption low, resistive loads at the FOUT and PWMOUT terminals increase dc power consumption and therefore should be as large as possible. Capacitive loads at the FOUT and PWMOUT terminals increase the TS3001's transient power consumption and, as well, should be as small as possible.

One challenge to minimizing the TS3001's transient power consumption is the probe capacitance of oscilloscopes and frequency counter instruments. Most instruments exhibit an input capacitance of 15pF or more. Unless buffered, the increase in transient load current can be as much as 400nA.

To minimize capacitive loading, the technique shown in Figure 1 can be used. In this circuit, the principle of series-connected capacitors can be used to reduce the effective capacitive load at the TS3001's FOUT and PWMOUT terminals.

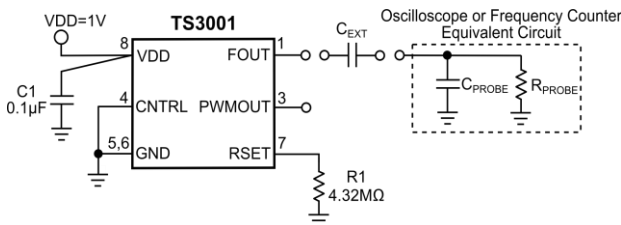

**Figure 1:** Using an External Capacitor in Series with Probes Reduces Effective Capacitive Load.

To determine the optimal value for  $C_{EXT}$  once the probe capacitance is known by simply solving for  $C_{EXT}$  using the following expression:

$$C_{EXT} = \frac{1}{\frac{1}{C_{LOAD(EFF)}} - \frac{1}{C_{PROBE}}}$$

For example, if the instrument's input probe capacitance is 15pF and the desired effective load capacitance at either or both FOUT and PWMOUT terminals is to be  $\leq 5$ pF, then the value of  $C_{EXT}$  should be  $\leq 7.5$ pF.

### TS3001 Start-up Time

As the TS3001 is powered up, its FOUT terminal (and PWMOUT terminal, if enabled) is active once the applied VDD is higher than 0.9 volt. Once the applied VDD is higher than 0.9 volt, the master oscillator achieves steady-state operation within 1.2ms.

### Current- and Voltage-Controlled Oscillators

The TS3001 can be configured into a Current-Controlled Oscillator as shown in Figure 2.

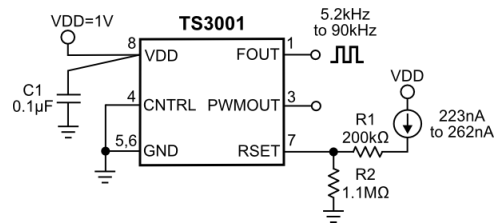

**Figure 2:** Configuring the TS3001 into a Current-Controlled Oscillator.

With a current source sourcing a current of 223nA to 262nA, FOUT can generate an output signal with a frequency range of 5.2kHz to 90kHz. In a similar manner, a Voltage-Controlled Oscillator can be configured as shown in Figure 3. In this case, a voltage source sourcing a voltage of 290mV to 341mV can generate an FOUT output signal frequency range of 5.2kHz to 90kHz as well. It is recommended to use resistor values with a 1% tolerance.

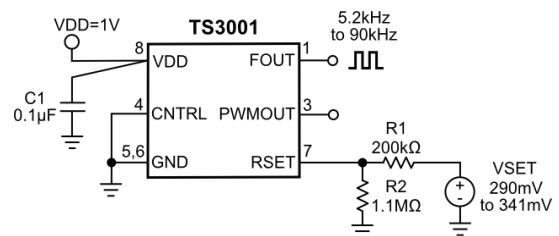
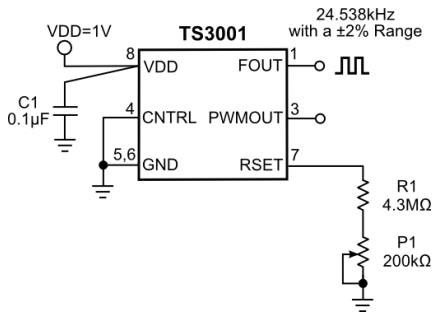

**Figure 3:** Configuring the TS3001 into a Voltage-Controlled Oscillator.



## Using a Potentiometer to Trim the TS3001's Output Frequency

By using a fixed resistor and a potentiometer, the output frequency of the TS3001 can be trimmed as shown in Figure 4. By selecting a fixed resistor R1 with a tolerance of 0.1% and a potentiometer P1 with a 5% tolerance, the output frequency can be trimmed to provide a  $\pm 2\%$  trimming range. As shown in Figure 4, R1+P1 set the output frequency to 25.052kHz when P1 = 0 $\Omega$  and with P1 = 200k $\Omega$ , the resulting output frequency is 24.024kHz.



**Figure 4:** Using a Fixed Resistor and a Potentiometer to Trim the TS3001's Output Frequency.

## Using Standard Resistors to Increase FOUT Resolution

The TS3001 can be configured to provide a 0.1% resolution on the output frequency as shown in Figure 5. To do so, R1 can be set to approximately 10% of the value selected for R2. In addition, R2 and R1 should be chosen with a 0.1% and 1% tolerance, respectively. Since R2 is 90% of the total resistance, it has the largest impact on the resolution of the output frequency. With R1 = 91k $\Omega$  and R2 = 910k $\Omega$ , the output frequency is 90kHz and with R1 = 400k $\Omega$  and R2 = 4M $\Omega$ , the output frequency is 23kHz.

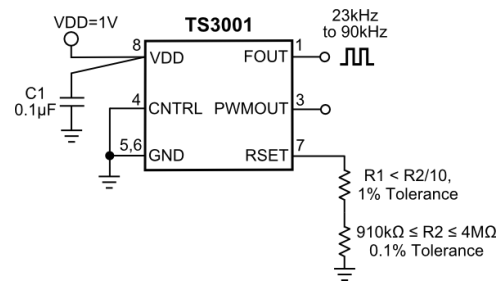
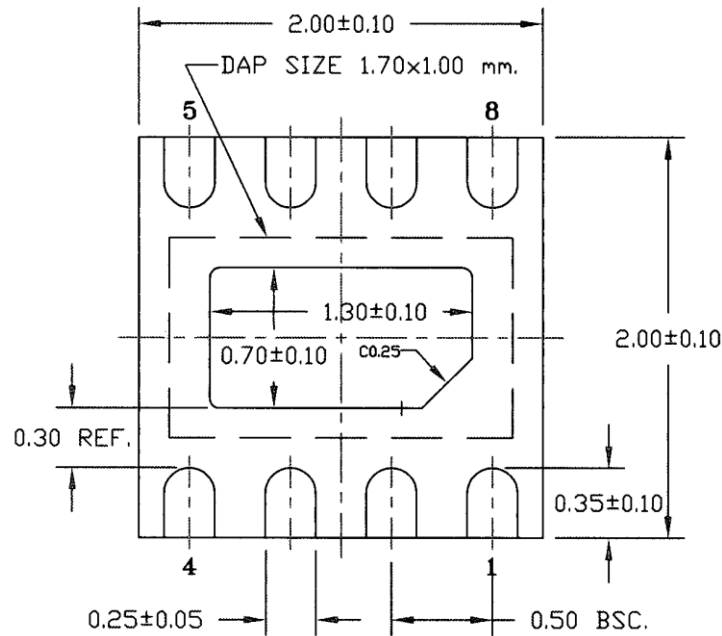

**Figure 5:** Setting the TS3001's Output Frequency to 0.1% Resolution using Standard Resistors.

## PACKAGE OUTLINE DRAWING

### 8-Pin TDFN22 Package Outline Drawing

(N.B., Drawings are not to scale)



#### BOTTOM VIEW

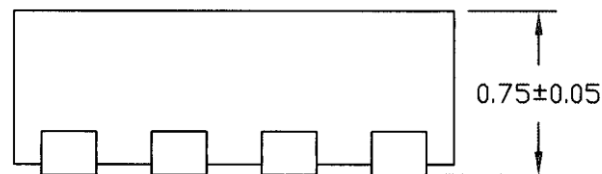

#### SIDE VIEW

#### NOTE:

All dimensions are in mm.  
Compliant with JEDEC MO-229

Information furnished by Touchstone Semiconductor is believed to be accurate and reliable. However, Touchstone Semiconductor does not assume any responsibility for its use nor for any infringements of patents or other rights of third parties that may result from its use, and all information provided by Touchstone Semiconductor and its suppliers is provided on an AS IS basis, WITHOUT WARRANTY OF ANY KIND. Touchstone Semiconductor reserves the right to change product specifications and product descriptions at any time without any advance notice. No license is granted by implication or otherwise under any patent or patent rights of Touchstone Semiconductor. Touchstone Semiconductor assumes no liability for applications assistance or customer product design. Customers are responsible for their products and applications using Touchstone Semiconductor components. To minimize the risk associated with customer products and applications, customers should provide adequate design and operating safeguards. Trademarks and registered trademarks are the property of their respective owners.