

SAW Bandpass Filter 206160B



1. Features

- IF Bandpass Filter
- Low-Loss Filter
- Single-Ended Operation
- Ceramic Surface Mount Device (SMD) Package
- Maximum Storage Temperature Range : -40 °C ~ 85 °C
- Electrostatics Sensitive Device (ESD)

2. Package Dimensions

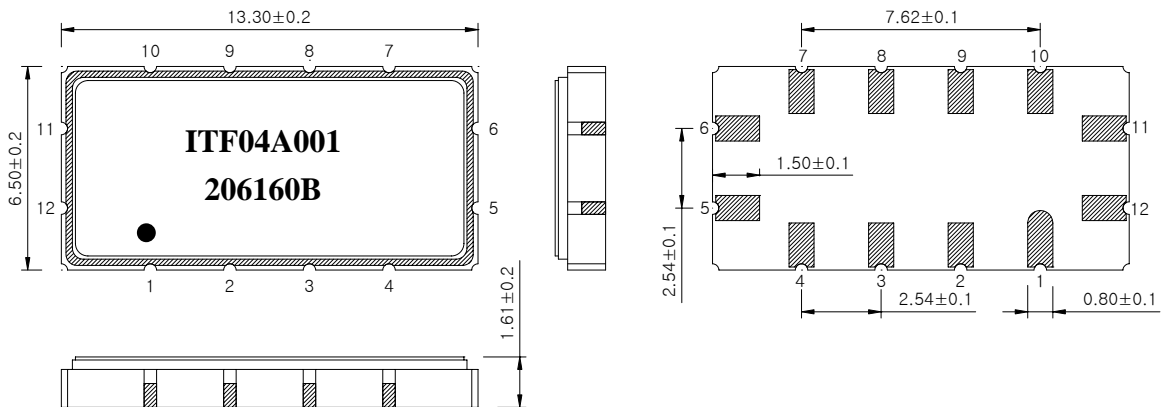

Package : S1365

Dimensions shown are nominal in millimeters

Body : Al₂O₃ Ceramic

Lid : Kovar, Ni Plated

Terminations : Au plating 0.3 ~ 1.0 um, Over a 1.27 ~ 8.89 um Ni Plating

Pad Configuration	
11	Input
5	Output
6, 12	Ground
Other	Case ground



ITF Co., Ltd.
 102-901, Bucheon Technopark 364,
 Samjeong-Dong, Ojeong-Gu, Bucheon-City,
 Gyeonggi-Do, Korea 421-809

Part No.	206160B	
Rev. Date	2004-04-29	
Rev.	NJ3004-CS02	1/5

SAW Bandpass Filter 206160B



3. Specifications

Fo = 70.0 MHz

Terminating source impedance : 50Ω and matching network

Terminating load impedance : 50Ω and matching network

		Minimum	Typical	Maximum
Center Frequency	MHz	69.8	70.0	70.2
Insertion Loss	dB	-	17.5	18.5
1dB Bandwidth	MHz	27.2	27.6	-
3dB Bandwidth	MHz	28.0	28.6	-
40dB Bandwidth	MHz	-	33.3	34.65
Amplitude Ripple (Fo +/- 12.5 MHz)	dB	-	0.7	1.0
Group Delay Variation (Fo +/- 12.5 MHz)	nsec	-	50	120
Absolute Delay	usec	-	1.0	-
Ultimate Rejection	dB	40	45	-
Temperature Coefficient of Frequency	ppm/°C	-	-86	-

Notes :

- 1) All specifications are based on the matching schematic shown below
- 2) All specifications are measured by Agilent Network analyzer and full 2 port calibration at room temperature
- 3) All attenuation measurements are measured relative to insertion loss

 Integrated Technology Future	ITF Co., Ltd. 102-901, Bucheon Technopark 364, Samjeong-Dong, Ojeong-Gu, Bucheon-City, Gyeonggi-Do, Korea 421-809	Part No.	206160B	
		Rev. Date	2004-04-29	
		Rev.	NJ3004-CS02	2/5

SAW Bandpass Filter 206160B



4. Matching Schematic

(Actual matching values may vary due to PCB layout and parasitics)

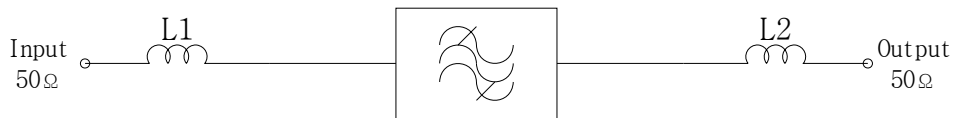

L1 = 180 nH, L2 = 100 nH

5. Marking Configuration

ITF¹⁾ 04A001²⁾

206160B³⁾

●⁴⁾

1) Manufacturer name

2) Lot Number

3) Part Number

4) Pad Number 1 Index

 Integrated Technology Future	ITF Co., Ltd. 102-901, Bucheon Technopark 364, Samjeong-Dong, Ojeong-Gu, Bucheon-City, Gyeonggi-Do, Korea 421-809	Part No.	206160B	
		Rev. Date	2004-04-29	
		Rev.	NJ3004-CS02	3/5

SAW Bandpass Filter 206160B



6. Typical Performance (at +25°C)

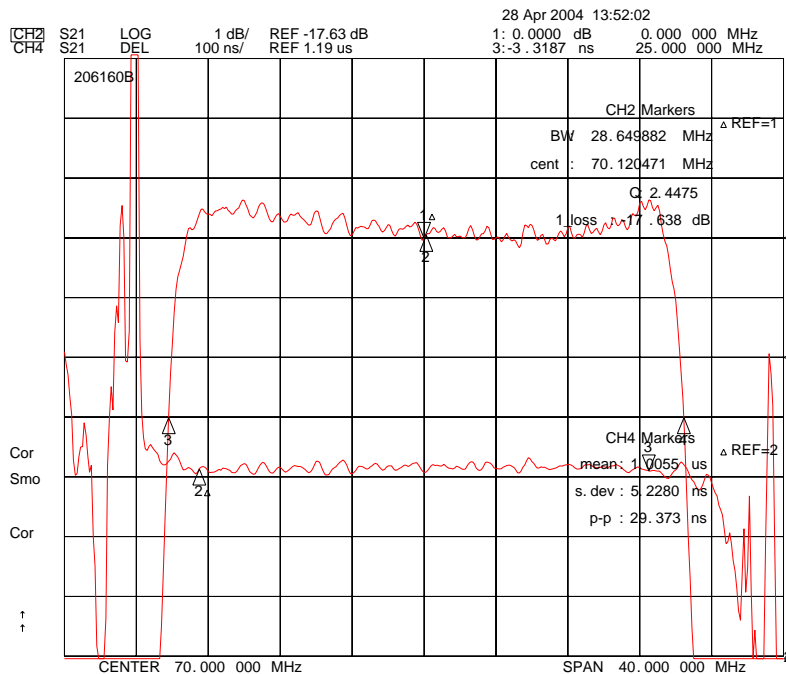
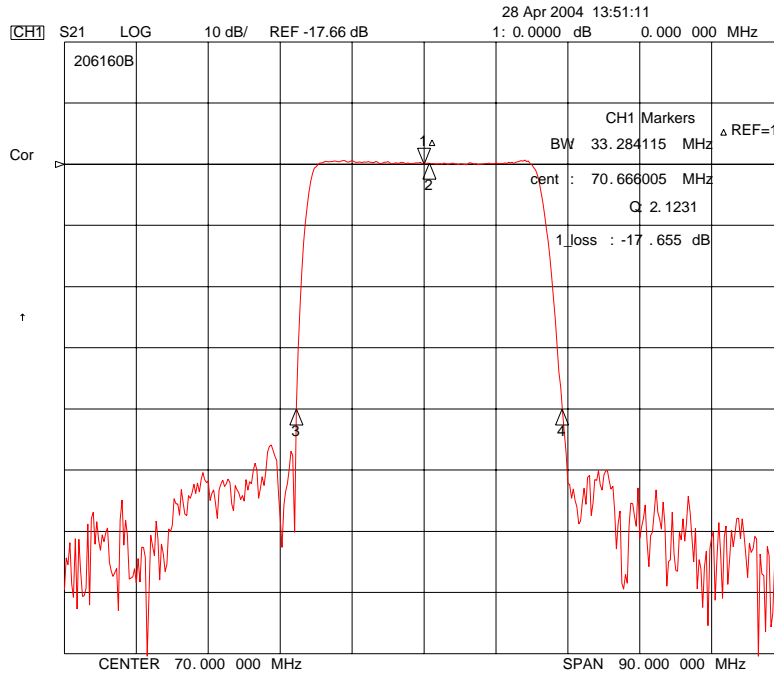

ITF Co., Ltd.
 102-901, Bucheon Technopark 364,
 Samjeong-Dong, Ojeong-Gu, Bucheon-City,
 Gyeonggi-Do, Korea 421-809

Part No. 206160B

Rev. Date 2004-04-29

Rev. NJ3004-CS02 4/5

SAW Bandpass Filter 206160B

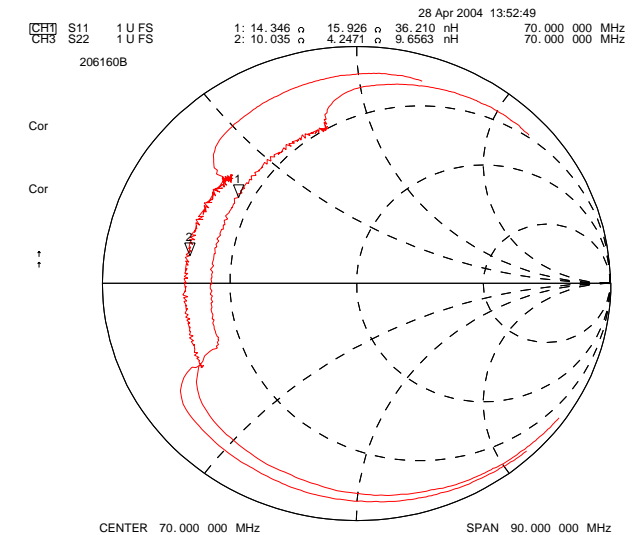
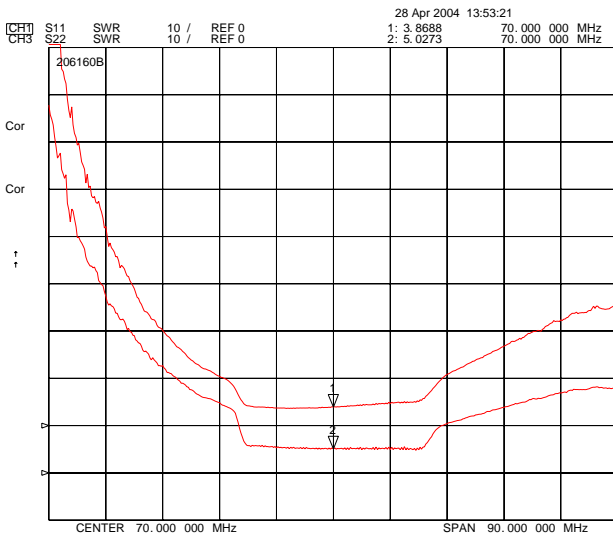
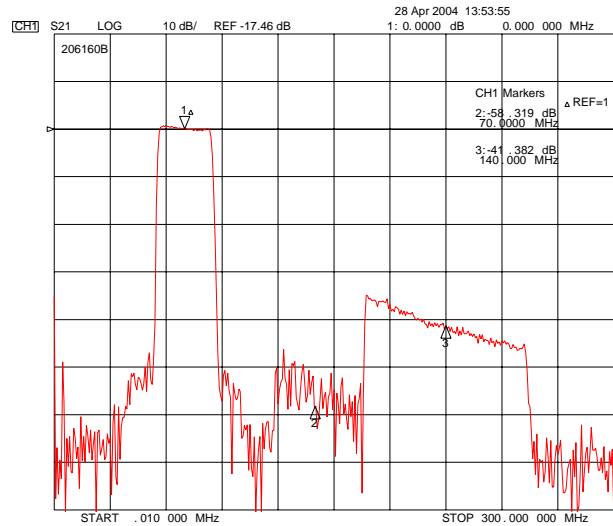
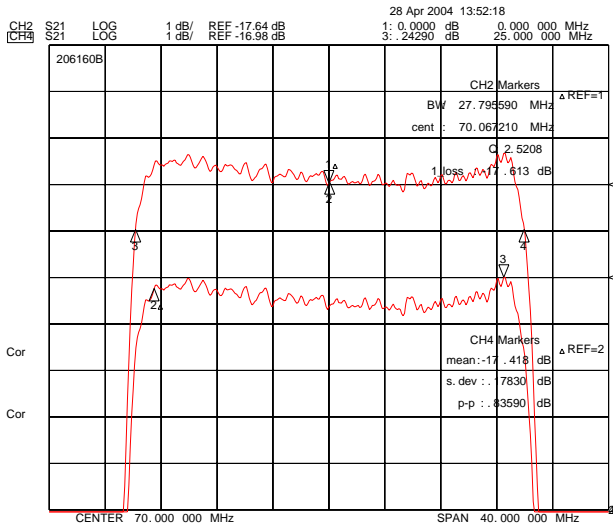

ITF Co., Ltd.
 102-901, Bucheon Technopark 364,
 Samjeong-Dong, Ojeong-Gu, Bucheon-City,
 Gyeonggi-Do, Korea 421-809

Part No. 206160B

Rev. Date 2004-04-29

Rev. NJ3004-CS02 5/5