

PORTABLE TYPE ULTRASONIC FLOWMETER (PORTAFLOW)

DATA SHEET

FLB

Besides having feature of an ultrasonic flowmeter in that flow rate can be measured from the outside of the pipe, this flowmeter has a built-in microcomputer which further enhances its portability. A single flowmeter can be applied to various piping, and it is usable easily by anyone anywhere.

FEATURES

- Flow rate easily measurable from the outside of existing piping**
The measuring principle is the same as with Fuji's other ultrasonic flowmeters of which a many number have already been delivered to customers — flow rate is measured just by attaching sensors to the outside of a pipe. So it is unnecessary to process or machine the pipe, and there is no pressure loss of the fluid.
- Easy to carry since it is compact, lightweight**
The main unit measures only 370mm wide by 290mm high by 135mm deep, and weighs only about 7kg.
- A single flowmeter applicable to a wide range of pipes, from small to large bores**
Applicable to pipes of $\phi 25$ to $\phi 350$ with small sensor (standard-equipped), and pipes of $\phi 200$ to $\phi 6000$ with large sensor (optional).
- Easy operation, since built-in microcomputer takes care of troublesome calculations**
An interactive system with key operation and display is employed. Anyone can readily operate it just by following the sequence instructed on the display.
- Easy readout and recording of measured data and set data with digital liquid-crystal display and printer**
- Operable on various power supplies**
The Portaflo will operate on 90 to 120V or 180 to 240V AC, 50/60Hz, or on 10 to 30V DC. It can also be operated from a mobile generator, battery, or automobile cigarette lighter socket.
- Measured data appear immediately on display and printer, and can be stored in built-in memory**
Data stored in the memory can be subjected to processing later on a personal computer.

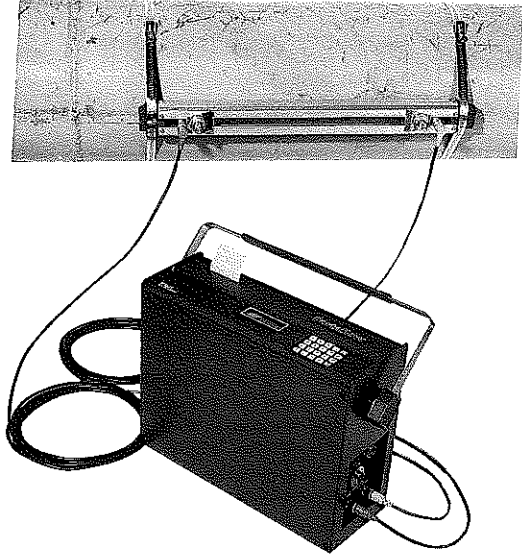

CODE SYMBOLS

| 1 2 3 4 5 6 7 8 | | | | | | | | Description | |
|-----------------|---|---|---|---|---|---|---|-------------|-------------|
| F | L | B | 0 | 0 | 0 | 4 | | | |
| | | | | | | | 1 | ----- | In Japanese |
| | | | | | | | 2 | ----- | In English |

SCOPE OF DELIVERY

| | |
|---|--------|
| Flowmeter | 1 |
| Small sensor (with mounting fixture and 5m cable) | 1 set |
| Soft case (metallic silver) | 1 |
| Shoulder strap | 1 |
| Compound (100g) for attaching sensor | 1 |
| Power cord (2m, for AC and DC) | 1 each |
| Roll paper for printer (25m per roll) | 2 |
| Automobile cigarette lighter cord (5m) | 1 |

STRUCTURE

Portaflow main unit

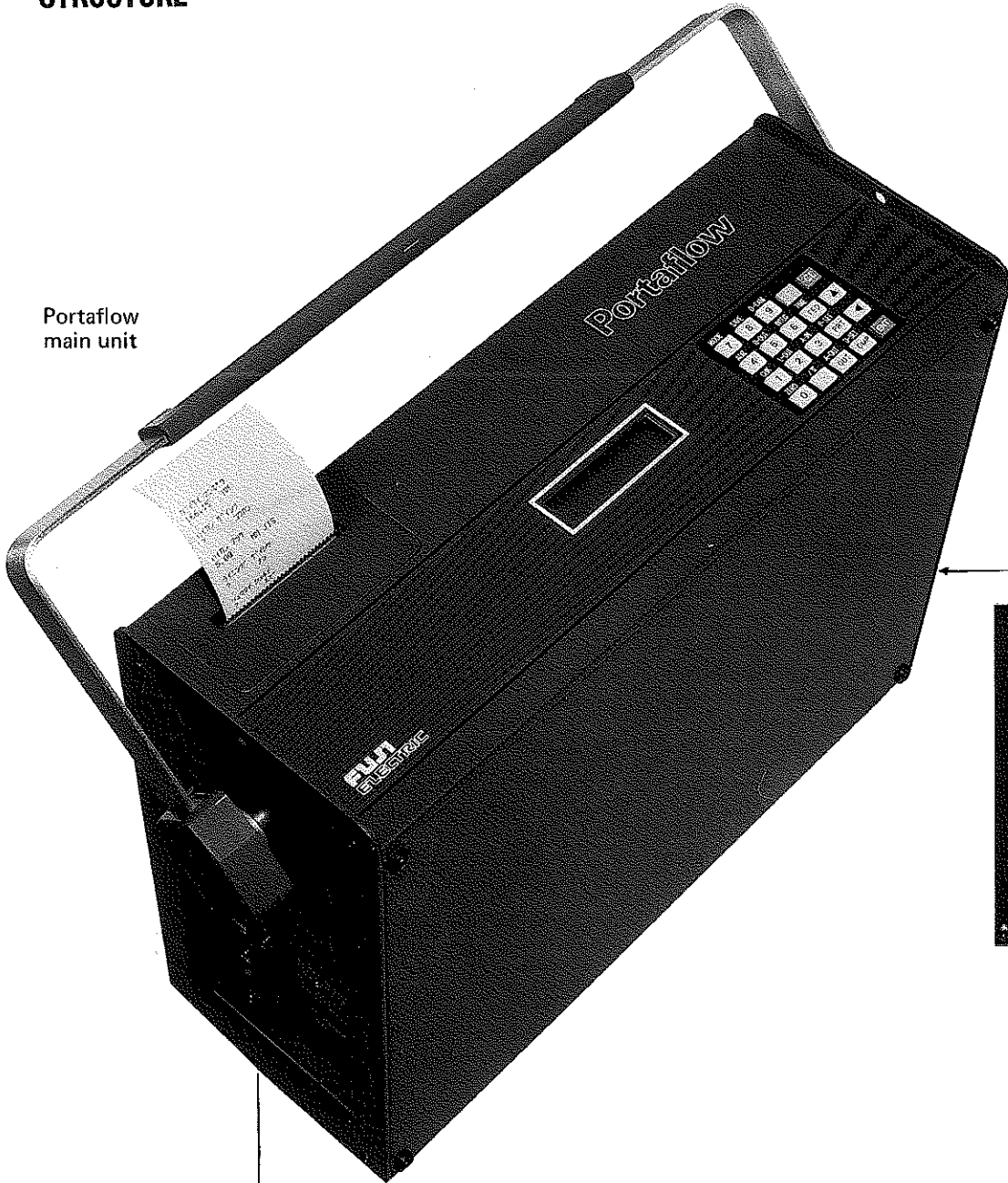

Connectors for sensor, analog input/output, personal computer interface, scanner

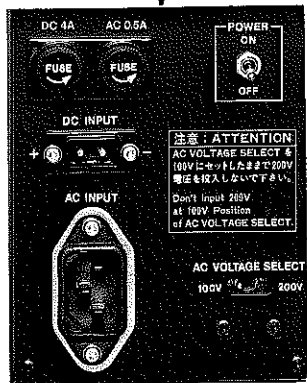

Power connectors and switches

Sensor

Mounting band

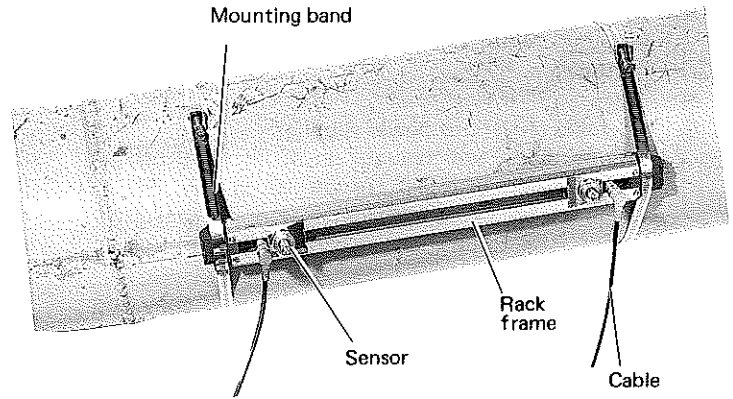

Sensor

Rack frame

Cable

SPECIFICATIONS

The table below lists the specifications. The items in the "Specification" column are standard, and according to the separately sold accessories and functions included in the Portaflow, there are the "Expanded Specifications" as given in right column.

| Item | Specification | Expanded Specifications |
|--|--|--|
| Measured fluid specification | Kind: Fluids through which ultrasonic waves can pass (service water, sewage, seawater etc.), provided the following conditions must be met Turbidity: 10000 deg. (mg/ℓ) or less Bubbles: None | It can be examined whether other fluids are measurable via the test function of Portaflow. |
| | Temperature: -40 to 100°C | Consult with Fuji other than given at left. |
| | Flow velocity: -16m/s to 0 to +16m/s | _____ |
| | Flow condition: Pipe is filled with water and flow is uniform | (1) When there is a drift or swirling flow, it is measurable with a multiple measuring wire system using the separately sold scanner and sensor. Consult with Fuji. (2) When there is a pulsating flow, stable measurement is possible with the built-in damping function. (3) Measurement is possible even if the flow direction changes. |
| Pipe specification | Kind: Standard pipes of steel, stainless steel, cast iron, PVC, FRP and asbestos | It can be examined whether other pipes are applicable via the test function of Portaflow. |
| | Bore: φ25 to 350mm (with standard small sensor) φ200 to 6000mm (with optional large sensor) | Consult with Fuji regarding bores smaller than φ25mm or larger than φ6000mm. |
| | Lining: Tar epoxy, mortar | It can be examined whether other linings are applicable via the test function of Portaflow. |
| | Straight pipe section length: 10D or more upstream, 5D or more downstream | If it is shorter than at left, measurement can be made by a multiple measuring wire method using the separately sold scanner and sensor. |
| Measuring site conditions | Ambient temperature-humidity: -20 to +60°C for sensor, -10 to 45°C for main unit, 90% RH or less Avoid use at a place where there is corrosive or explosive gas, acid, or strong radiation. Sensor connector are designed for indoor application. | Water proof construction is optional provided. Consult Fuji other than at left. |
| Power supply | 90 to 120V/180 to 240V AC, 50/60Hz, 10 to 30V DC Power consumption: Approx. 15W Memory backup power supply: Lithium battery | At a place without power supply, the separately sold battery-set, an engine generator or the like can be used. |
| | In the event of a power failure, the integrated value is held as it is, and at power recovery, integration is resumed from that point. | |
| Measuring accuracy | Indicated value ±1.5% (under standard conditions) However, indicated value ±0.015m/s with bore of φ250mm or more and flow velocity of 1m/s or less, indicated value ±0.03m/s with bore of less than φ250mm and flow velocity of 2m/s or less | |
| Response speed | Settable in 1 sec steps between 1 and 99 sec. | _____ |
| Data setting | Interactive method with keys and liquid crystal display. Memory function built in for set data such as fluid and pipe specification input, damping correction etc. | |
| Measured value display, recording etc. | Display: Digital liquid-crystal display, 16 digits in 2 rows Recording: 24-digit printer Instantaneous value, integrated value, time, flow direction etc. | Self-diagnosis, memorization of measured values, and data processing with a personal computer are also possible. |
| Analog input/output signals | 1 point each connectable for input and output 4 to 20mA DC (input resistance 200Ω, output load resistance 600Ω) | (1) Signal from another flowmeter, level gauge, pressure gauge, thermometer, water quality meter or the like can be input and displayed. Printout, memorization or calculation is also possible. (2) Besides the measured flow rate, the result of calculation with the input value can also be output. |
| Mass(weight) | Main unit: Approx. 7kg Small sensor: Approx. 1kg | _____ |
| Dimensions | Main unit: 290H x 370W x 135D mm Small sensor: 90H x 530W x 52D mm | _____ |
| Cable | 5m cable (with connector) provided with sensor | Separately sold sensor extension cord (10m) also connectable. |
| Finish color | Soft case: Metallic silver Main unit: Munsell 5Y 3/0.5 Sensor: Stainless cover Frame: Aluminum | |

DESCRIPTION OF KEYBOARD

Key operating method and functions

The key operation is mostly carried out via a dialogue with the digital display. First, it must be decided what function the Portaflow is to perform, and by pressing the key corresponding to that function, a menu appears on the digital display. Menu pages are fed by using the Δ \triangleleft keys, and when the required item is found, press the ENT key and the function is set on Portaflow.

For example, to carry out flow rate integration, press the F and INTEG keys, and the following will appear on the display.

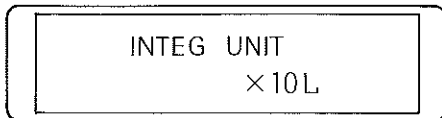

Next, press the Δ key and the m^3 changes, and the following appears on the display.

$\times 10\text{L}$ $\times 10\text{M}^3$
 $\times 100\text{L}$ $\times 100\text{M}^3$
 $\times \text{M}^3$ $\times 1000\text{M}^3$

Select an appropriate unit from among these, then press the ENT key and the unit is set. The following then appears on the display.

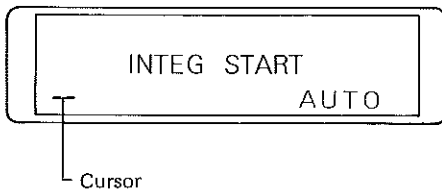

Next press the Δ key, and MANUAL and AUTO are changed over. Select one of the modes and press the ENT key. When AUTO is selected, the display changes as follows.

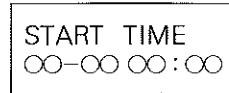

Set the date and time with the numerical keys and press the ENT key. When the start time arrives, the integration is started automatically.

The function of each of the keys is explained below.

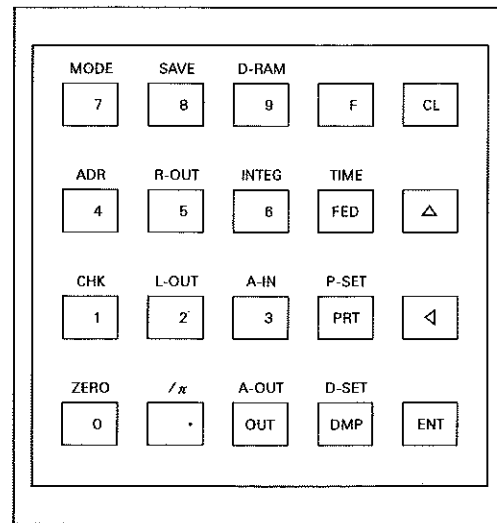

| | |
|--------------------|---|
| MODE | Used to designate the Portaflow function. The following functions are available. Flow rate measurement in one pipe, in multiple pipes of the same type, in multiple pipes of different types, etc., memory start, pipe inspection etc. |
| CHK (CHECK) | Used for check of Portaflow hardware such as display, printer, analog input/output etc. |
| ZERO | Used for zero adjustment. When this key is pressed with flow rate at zero, zero adjustment is made automatically. |
| SAVE | Used to register input data like pipe and fluid specifications etc. into the memory (save, list, clear). By registering the data, they can be called out from the memory for measurement next time without inputting again (with MODE at memory start). |
| R-OUT (RAM-OUT) | Used to print out later the measured data stored in the RAM. |
| L-OUT (Length-out) | Used to display and print out the sensor attachment length. |
| /π | By pressing this key after inputting the pipe outer dimension, it is converted to outer diameter. |
| D-RAM (DATA-RAM) | Used to store various measured values in the RAM. |
| INTEG | Used to set the flow rate integration conditions (unit, start, stop). |
| A-IN (ANALOG-IN) | Used to set the analog input span. |
| A-OUT (ANALOG-OUT) | Used to set the analog output unit and span and select the range (L, M, H). |

| | |
|-------------------------|--|
| OUT (Display OUT) | Used to set the measured value unit and display the measured value and analog input. |
| F (FUNCTION) | A function key. Press the F key to perform the function written above the other keys. |
| TIME | Used to display and set the time. |
| P-SET (PRINT-SET) | Used to determine the print conditions for the measured value. Printing interval, kind of data to be printed, printing start time (instantaneous value, integrated value, analog input etc.) |
| PRT (PRINT) | Used to print out the displayed items. |
| D-SET (SYSTEM DATA-SET) | Used for calibrating analog input. |
| DMP (DAMPING) | Used to set the measured value damping, 1 to 99 sec. |
| CL | Used to stop the dialogue with the display. Also to cancel a key operation and return to measured value display. |
| ENT | The keyed-in numerical data, items selected through dialogue and so on are set by pressing this key. In the case of a conversation, it changes to the next question. |
| FED | Used for feeding printer paper. Paper is fed while the key is depressed. |
| Δ | When this key is pressed during a dialogue with a menu displayed, the menu changes one page at a time. |
| Δ | Used to shift the cursor when correcting a position. Press this key and the cursor shifts leftward. |

ITEMS TO BE PREPARED SEPARATELY (Prepare when needed) Asterisked * items are available on the market

| Classification | Name | Specification | Comment |
|----------------|---------------------------------|--|---|
| Accessory | Battery set* | Maker: Furukawa Denchi Type: EB65 M-3 No. A with terminals Name: Paste storage battery Specification: 12V 60AH (5 hour rating) 200H x 171W x 304Dmm | The usable time of Portaflow with this battery is 2 days continuously when printer is not used, and 24 hours when printer is used continuously. Although a 12V or 24V battery on hand can be used, the usable time depends on the capacity. The aforementioned figures are approximate times. |
| | Battery charger* | Maker: Furukawa Denchi Type: KAV12-100F Name: One-touch type automatic charger Specification: DC output 12V 20A AC input 100/200V selectable Dimensions; H200 x W330 x D250mm Mass(weight); Approx. 11kg | A charger for the above-mentioned. |
| | Engine generator* | Maker: Honda Type: EM-400 Specification: AC 100V 400VA (60Hz) 330VA (50Hz) DC 12V 8.3A Dimensions; 325H x 250W x 355Dmm Mass(weight); 18kg Tank capacity; Gasoline 2 lit. (approx. 4 hour charging) | A generator with output of either 100 or 200V AC or 12 or 24V DC is usable. But note that if a load besides Portaflow is connected to the generator, and the voltage fluctuates by more than $\pm 10\%$ due to load fluctuation, it will have an adverse effect on Portaflow. |
| | Large sensor | Type: FLG1L003 Includes 2 large detectors, 2 connecting cables (5m), 2 wire ropes and 2 springs | This is used with pipe bores of $\phi 200$ to 6000mm. The standard-equipped small sensor is usable with bores from $\phi 25$ to 350mm. |
| | Pipe thickness gauge* | Maker: Kawatetsu Measuring Instruments Type: TI-7S Specification: Measurable materials Steel, cast iron, aluminum and other metals, glass, hard resin, ceramic, etc. Measuring range; 1.0 to 199.9mm Indication unit; 0.1mm Accuracy; ± 0.1 mm or $\pm 0.5\%$ of rdg | When inputting pipe data into Portaflow, the pipe thickness should also be keyed in. Use this thickness gauge to measure it when the thickness is unknown. Note that typical pipe thickness data of JIS standards are stored in Portaflow's memory, and it is usually all right to use this data. But for measurement with particularly high accuracy, it is necessary to actually measure the outer circumference and thickness. Note: With JIS steel pipe, the allowable thickness error is usually $\pm 10\%$. With JIS cast iron pipe, the allowable thickness error is -10% (+unspecified). |
| | Scanner | No. of changeover points: 8 Changeover cycle: 1 min min. (multi-pipings) 1 sec min. (multi-measurements) Power supply: By Portaflow | This scanner is used in the following two ways. (1) Flow rates for eight pipes are measured with one Portaflow while changing over the pipes sequentially and automatically with the scanner. (2) When there is a drift or swirling flow in the flow velocity distribution in a pipe, and high-accuracy measurement is to be made by multiple measuring wire method with the no. of sensors increased, then measurement is made with one Portaflow while changing over up to 8 sensors sequentially and automatically with the scanner. Note: When the scanner is used, there will be added expense for the sensors. |
| | Sensor extension cord | Two FLB cables of 10m, with connectors (TK752994C13) | The cord connected to the sensor is 5m long, so the extension cord is required when the distance between the sensor and Portaflow is longer than this. |
| | Analog input/output cord | One cord of 1m (TK774626C1) | Use this cord for connecting an analog input to Portaflow or for taking out an analog flow rate output signal from Portaflow. |
| | Personal computer interface | Applicable personal computer: MSX specification | For processing the measured data stored in the Portaflow memory with a personal computer, then place this interface in between for connection to the computer. |
| Spares | Printer roll paper* | Maker: Seiko Instruments Inc. Type: TP058-25C | One roll is 25m long and can print out about 6550 lines. The line spacing is 3.8mm. |
| | Compound * for attaching sensor | Maker: Shin-Etsu Chemical Co., Inc. Type: G40M, tube containing 100g | One tube can be used about 30 times for attaching sensors. |
| Other | Small sensor for expansion | Type: FLG1S103 Small sensor plug mounting fixture and 5m cable, one set | Used with the multiple measuring wire system and so on. |
| | Water-proof small sensor | Type: FLG1S003 Small sensor plug mounting fixture and 5m cable, one set | Water-proof construction 5m cable is integrated with sensor |

OUTLINE DIAGRAM (Unit: mm)

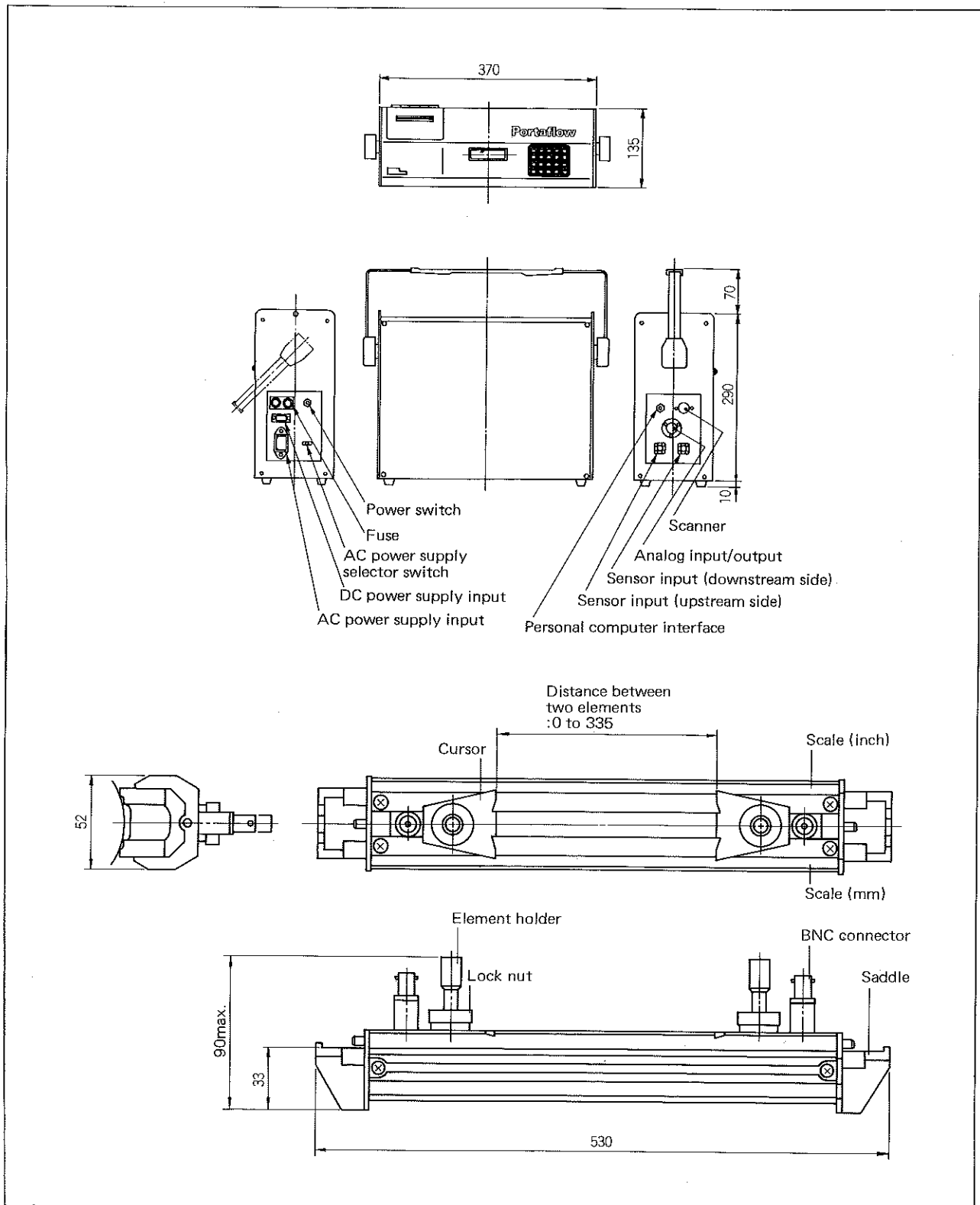

Fuji Electric Co.,Ltd.

Head office

12-1 Yurakucho 1-chome, Chiyoda-ku Tokyo. 100 Japan
 Phone: Tokyo 3211-7111
 Telex: J22331 FUJIELEA or FUJIELEB

Instrumentation Systems Div.

No. 1, Fuji-machi, Hino-city, Tokyo 191 Japan
 Phone: 0425-85-2800
 FAX: 0425-85-2810