

Features

- +4 dBm Output Level at 675 MHz
- Channel Step Size : 20 kHz
- 2nd Harmonic : < -20 dBc
- Spurious Level : < -70 dBc
- Lock Time : < 10 ms
- 16 mA Current Consumption

Description

The plerow™ PLL synthesizer module was designed for use in wireless and wireline systems in a wide range of frequency from 50 MHz to 6 GHz. ASB's PLL provides exceptionally low spurious and phase noise performance with fast locking time and low current consumption. All products are available in a surface-mount type package.



Specifications

Parameter	Unit	Min.	Typical	Max.
Frequency Range	MHz	670	675	680
Output Power	dBm	3	4	5
Supply Voltage	V	4.7	5.0	5.3
Current Consumption	mA		16	30
Channel Step Size	kHz		20	
2 nd Harmonics	dBc		-30	-20
Spurious Level	dBc		-78	-70
Lock Time	ms		3	10
Reference Frequency	MHz		10	
Reference Input Level	dBm	-5	0	5
Phase Noise (C / N)				
@ 10 kHz	dBc/Hz	-110	-107	-104
@ 100 kHz	dBc/Hz	-124	-121	-118
Output Impedance	Ω		50	
Operating Temp. Range	°C	-40	25	85
Package Type & Size	mm	SMT, 19.0W×19.0L×5.8H		

1) Measurement conditions are as follows: T = 25°C, V_{CC} = 5 V, Freq. = 675 MHz, 50 ohm system.

More Information

Website: www.asb.co.kr
E-mail: sales@asb.co.kr

Tel: (82) 42-528-7220
Fax: (82) 42-528-7222

ASB, Inc., 4th Fl. Venture Town
Bldg, KT HRDC, 367-17
Goijeong-Dong, Seo-Gu,
Daejeon, 302-716, Korea

Outline Drawing

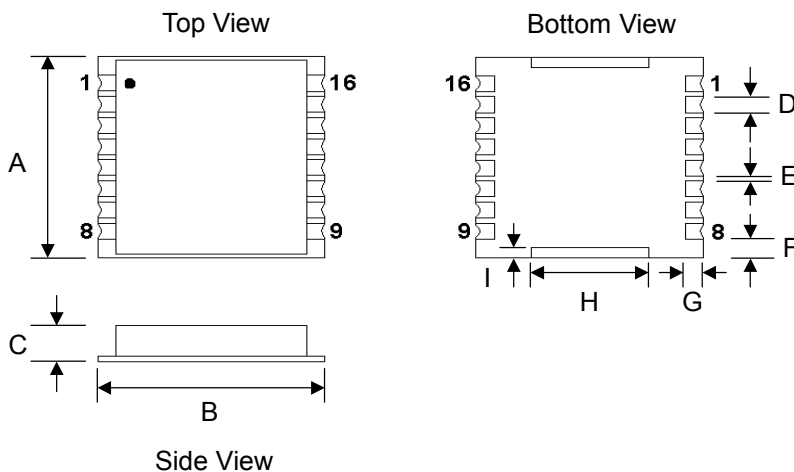

Pin Configuration		Dimension (mm)	
1	CLOCK	A	19.0
2	DATA	B	19.0
3	ENABLE	C	5.8
4	OSC IN	D	1.5
9	VCC (VCO)	E	0.5
13	RF OUT	F	1.75
15	VCP (PLL)	G	1.35
16	LOCK DETECT	H	15.0
Others	Ground	I	0.9
		Tolerance: ± 0.2	