



SANYO Semiconductors

DATA SHEET

An ON Semiconductor Company

TIG111GMH — N-Channel Non Punch Through IGBT High Power High Speed Switching Applications

Features

- Low-saturation voltage
- Ultrahigh speed switching
- Enhancement type

Specifications

Absolute Maximum Ratings at Ta=25°C, Unless otherwise specified

Parameter	Symbol	Conditions	Ratings	Unit
Collector-to-Emitter Voltage	V _{CE} S		600	V
Gate-to-Emitter Voltage	V _{GE} S		±30	V
Collector Current (DC)	I _C *1	Limited by T _j max	32	A
	I _C *2	Limited by T _j max	@T _c =25°C*3	21
			@T _c =100°C*3	10
Collector Current (Pulse)	I _{CP}	Pulse width Limited by T _j max	128	A
Allowable Power Dissipation	P _D		3	W
		T _c =25°C (SANYO's ideal heat dissipation condition)*3	55	W
Junction Temperature	T _j		150	°C
Storage Temperature	T _{stg}		-55 to +150	°C

Note : *1 Shows chip capability

*2 Collector current is calculated from the following formula

$$I_C(T_C) = \frac{T_{jmax} - T_C}{R_{th(j-c)} \times V_{CE(sat)max}(T_{jmax}, I_C(T_C))}$$

*3 SANYO's condition is radiation from backside.

The method is applying silicone grease to the backside of the device and attaching the device to water-cooled radiator made of aluminium.

Package Dimensions

unit : mm (typ)

7504-003

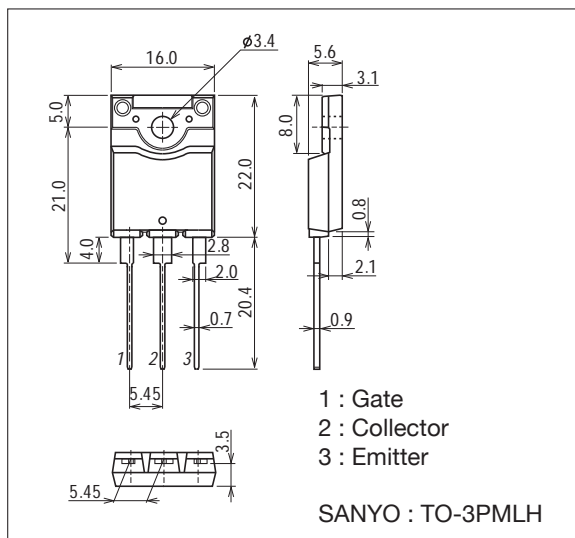

Product & Package Information

- Package : TO-3PMLH
- JEITA, JEDEC : SC-93, TO-247, SOT-199
- Minimum Packing Quantity : 100 pcs./tray

Marking

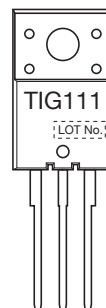

Electrical Connection

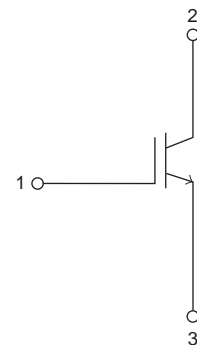

TIG111GMH

Electrical Characteristics at $T_j=25^\circ\text{C}$, Unless otherwise specified

Parameter	Symbol	Conditions	Ratings			Unit
			min	typ	max	
Collector-to-Emitter Breakdown Voltage	$V_{(BR)CES}$	$I_C=1\text{mA}, V_{GE}=0\text{V}$	600			V
Collector-to-Emitter Cutoff Current	I_{CES}	$V_{CE}=600\text{V}, V_{GE}=0\text{V}$			100	μA
					1	mA
Gate-to-Emitter Leakage Current	I_{GES}	$V_{GE}=\pm 30\text{V}, V_{CE}=0\text{V}$			± 100	nA
Gate-to-Emitter Threshold Voltage	$V_{GE(off)}$	$V_{CE}=10\text{V}, I_C=1\text{mA}$	4.0	5.0	6.0	V
Collector-to-Emitter Saturation Voltage	$V_{CE(sat)1}$	$V_{GE}=15\text{V}, I_C=10\text{A}$		1.6	2.0	V
	$V_{CE(sat)2}$	$V_{GE}=15\text{V}, I_C=25\text{A}$		2.2		V
Input Capacitance	C_{ies}	$V_{CE}=30\text{V}, f=1\text{MHz}$		1880		pF
Output Capacitance	C_{oes}			30		pF
Reverse Transfer Capacitance	C_{res}			22		pF
Turn-ON Delay Time	$t_{d(on)}$			43		ns
Rise Time	t_r	$L=200\mu\text{H}, V_{GE}=15\text{V}, I_C=10\text{A}, V_{CC}=300\text{V}, R_g=30\Omega$, See specified Test Circuit.		25		ns
Turn-ON Time	t_{on}			250		ns
Turn-OFF Delay Time	$t_{d(off)}$			175		ns
Fall Time	t_f			115		ns
Turn-OFF Time	t_{off}			360		ns
Total Gate Charge	Q_g				63	
Gate-to-Source Charge	Q_{gs}	$V_{CE}=300\text{V}, V_{GE}=15\text{V}, I_C=10\text{A}$		12		nC
Gate-to-Drain "Miller" Charge	Q_{gd}			22		nC

Thermal Characteristics at $T_a=25^\circ\text{C}$, Unless otherwise specified

Parameter	Symbol	Conditions	Ratings			Unit
			min	typ	max	
Thermal Resistance (Junction- Case)	$R_{th(j-c)}$	$T_c=25^\circ\text{C}$ (SANYO's ideal heat dissipation condition)*3			2.27	$^\circ\text{C} / \text{W}$
Thermal Resistance (Junction- at mosphere)	$R_{th(j-a)}$				41.7	$^\circ\text{C} / \text{W}$

Switching Time Test Circuit

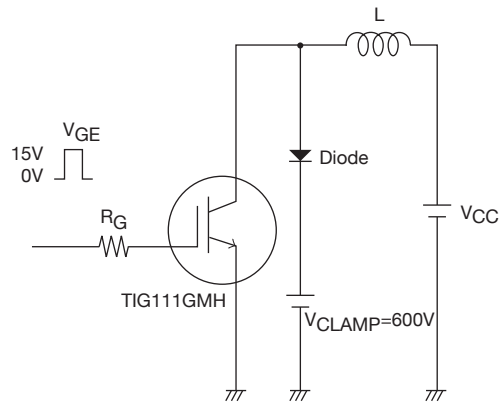

Timing Chart

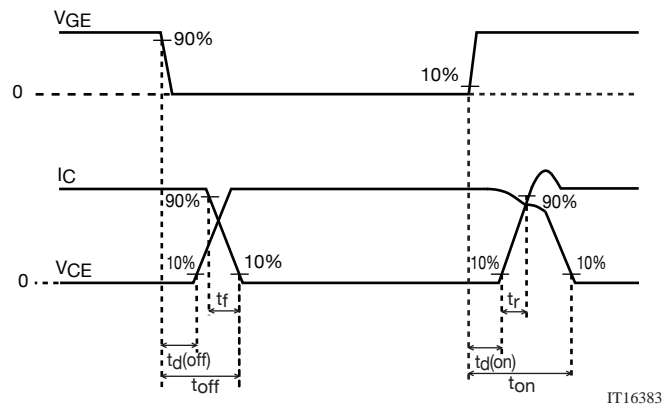

IT16383

TIG111GMH

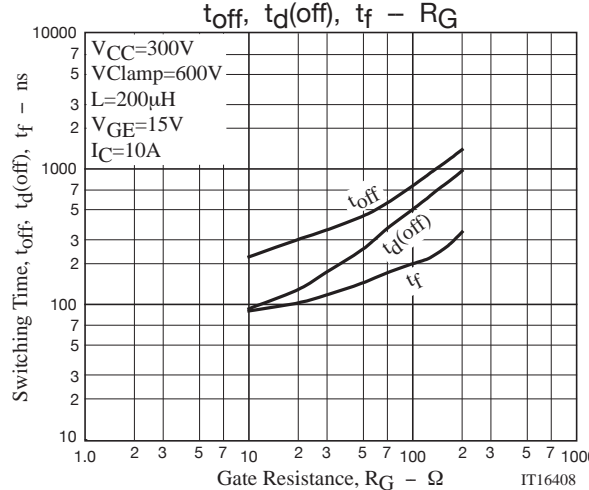
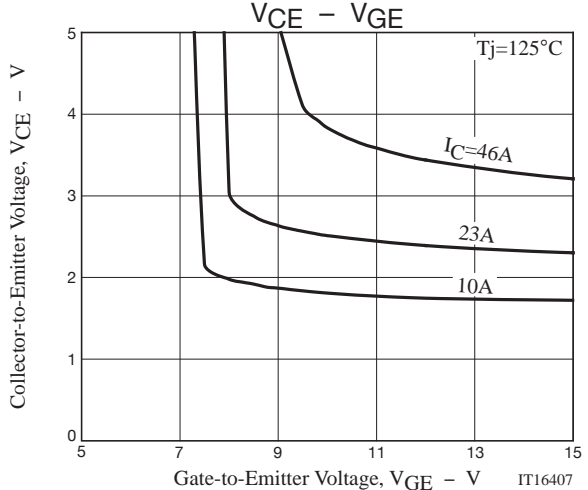
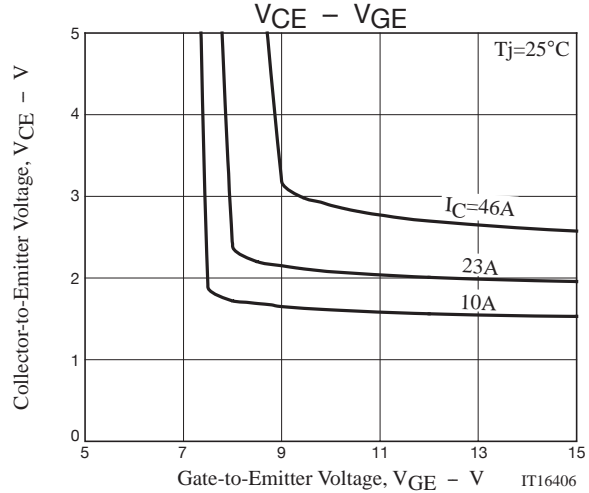
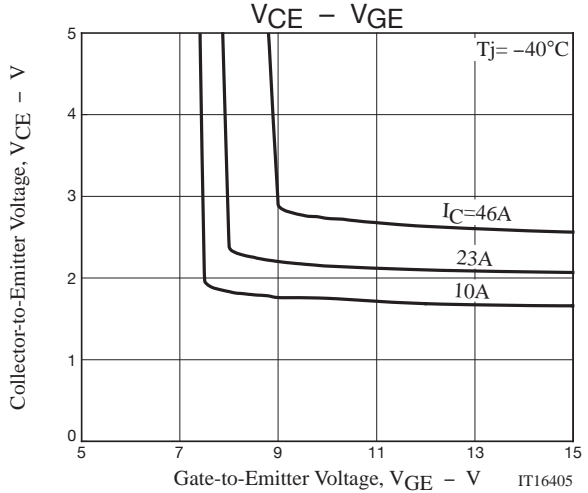
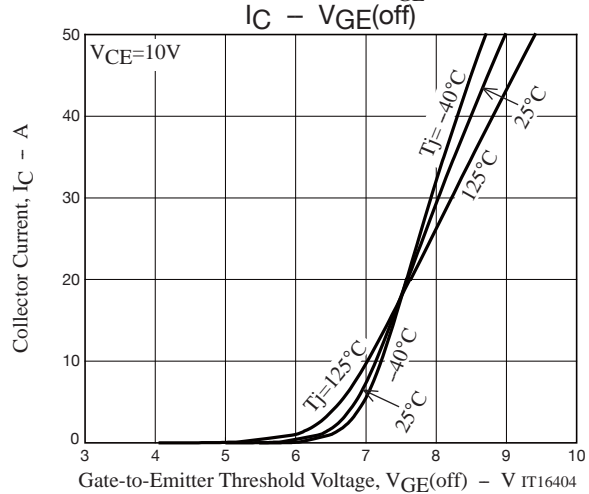
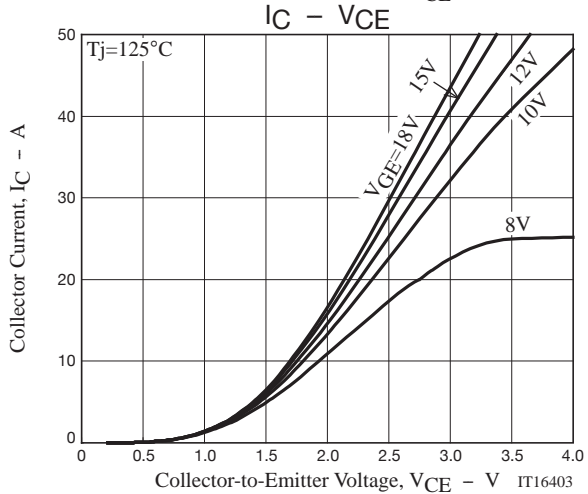
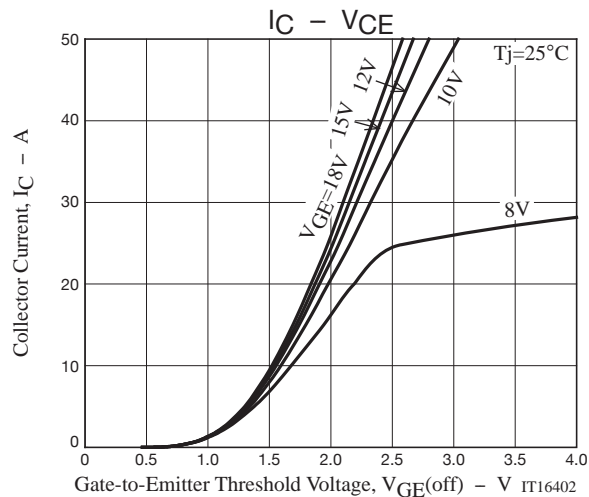
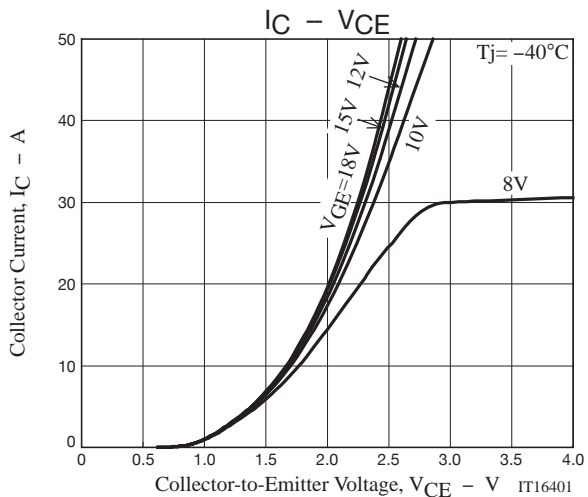

TIG111GMH

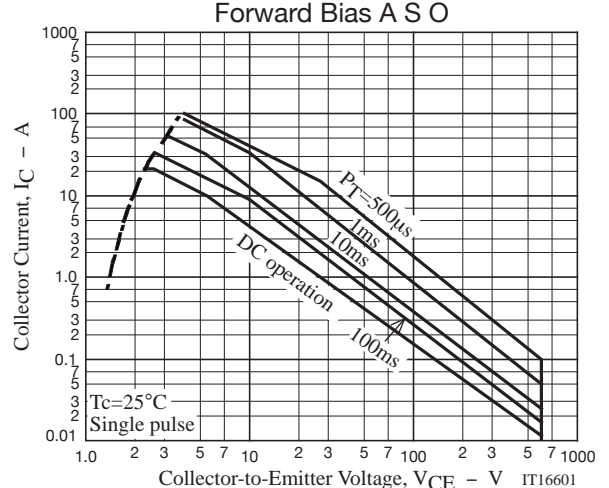
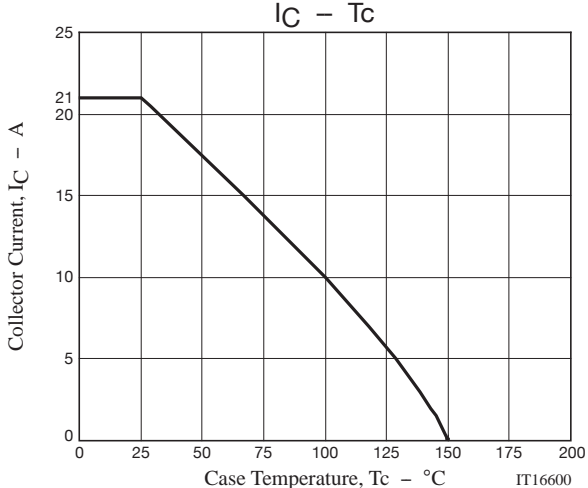
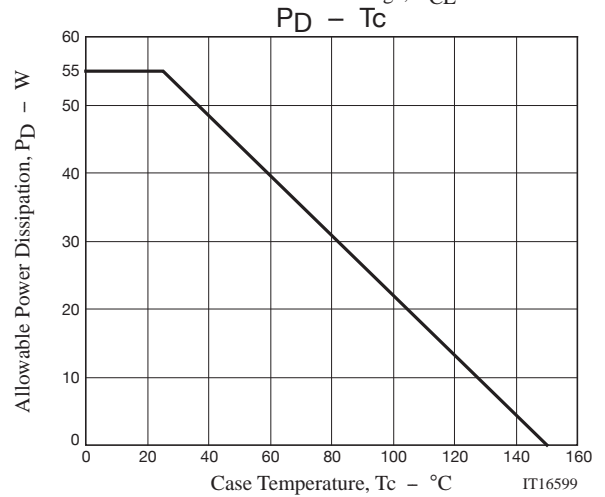
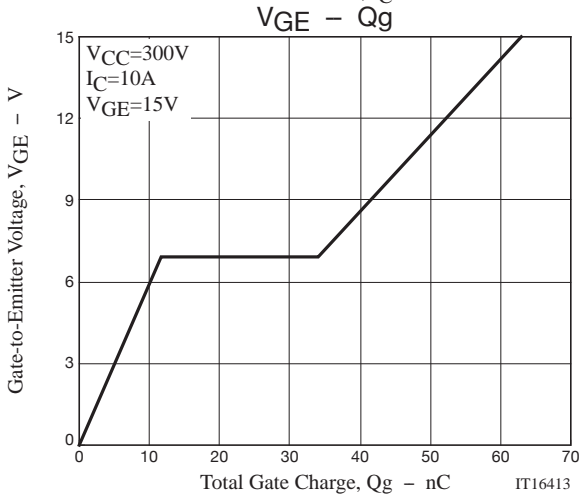
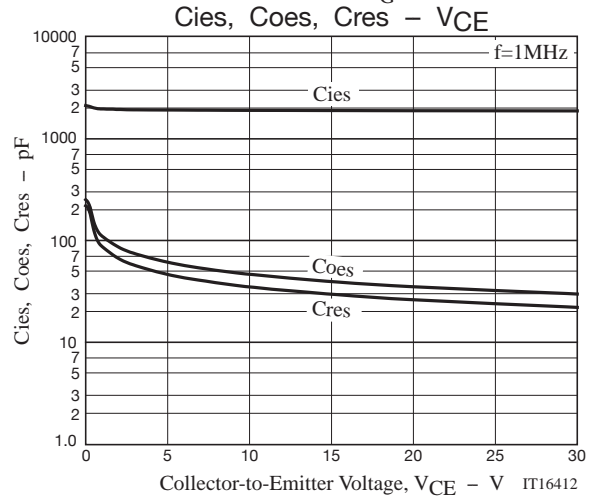
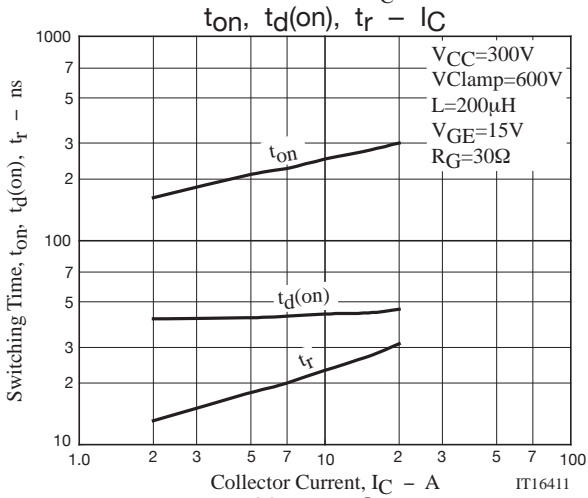
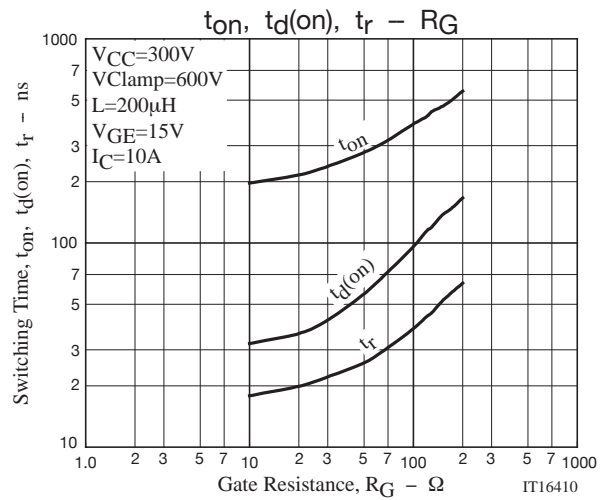
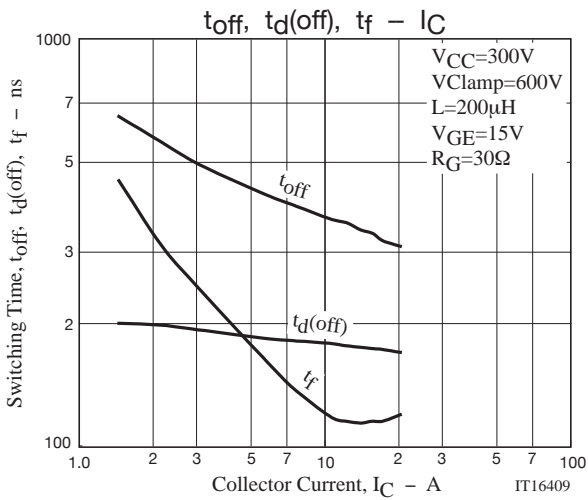

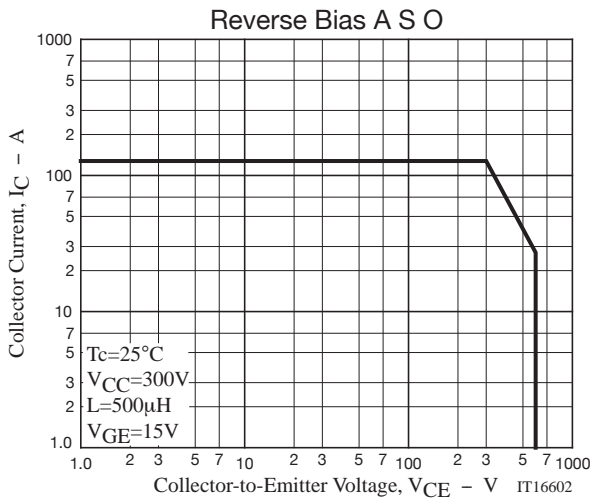

- Any and all SANYO Semiconductor Co.,Ltd. products described or contained herein are, with regard to "standard application", intended for the use as general electronics equipment. The products mentioned herein shall not be intended for use for any "special application" (medical equipment whose purpose is to sustain life, aerospace instrument, nuclear control device, burning appliances, transportation machine, traffic signal system, safety equipment etc.) that shall require extremely high level of reliability and can directly threaten human lives in case of failure or malfunction of the product or may cause harm to human bodies, nor shall they grant any guarantee thereof. If you should intend to use our products for new introduction or other application different from current conditions on the usage of automotive device, communication device, office equipment, industrial equipment etc. , please consult with us about usage condition (temperature, operation time etc.) prior to the intended use. If there is no consultation or inquiry before the intended use, our customer shall be solely responsible for the use.
- Specifications of any and all SANYO Semiconductor Co.,Ltd. products described or contained herein stipulate the performance, characteristics, and functions of the described products in the independent state, and are not guarantees of the performance, characteristics, and functions of the described products as mounted in the customer's products or equipment. To verify symptoms and states that cannot be evaluated in an independent device, the customer should always evaluate and test devices mounted in the customer's products or equipment.
- SANYO Semiconductor Co.,Ltd. assumes no responsibility for equipment failures that result from using products at values that exceed, even momentarily, rated values (such as maximum ratings, operating condition ranges, or other parameters) listed in products specifications of any and all SANYO Semiconductor Co.,Ltd. products described or contained herein.
- SANYO Semiconductor Co.,Ltd. strives to supply high-quality high-reliability products, however, any and all semiconductor products fail or malfunction with some probability. It is possible that these probabilistic failures or malfunction could give rise to accidents or events that could endanger human lives, trouble that could give rise to smoke or fire, or accidents that could cause damage to other property. When designing equipment, adopt safety measures so that these kinds of accidents or events cannot occur. Such measures include but are not limited to protective circuits and error prevention circuits for safe design, redundant design, and structural design.
- In the event that any or all SANYO Semiconductor Co.,Ltd. products described or contained herein are controlled under any of applicable local export control laws and regulations, such products may require the export license from the authorities concerned in accordance with the above law.
- No part of this publication may be reproduced or transmitted in any form or by any means, electronic or mechanical, including photocopying and recording, or any information storage or retrieval system, or otherwise, without the prior written consent of SANYO Semiconductor Co.,Ltd.
- Any and all information described or contained herein are subject to change without notice due to product/technology improvement, etc. When designing equipment, refer to the "Delivery Specification" for the SANYO Semiconductor Co.,Ltd. product that you intend to use.
- Upon using the technical information or products described herein, neither warranty nor license shall be granted with regard to intellectual property rights or any other rights of SANYO Semiconductor Co.,Ltd. or any third party. SANYO Semiconductor Co.,Ltd. shall not be liable for any claim or suits with regard to a third party's intellectual property rights which has resulted from the use of the technical information and products mentioned above.

This catalog provides information as of September, 2011. Specifications and information herein are subject to change without notice.