

TOSHIBA CMOS Integrated Circuit Silicon Monolithic

TCV7106FN

Buck DC-DC Converter IC

The TCV7106FN is a single-chip buck DC-DC converter IC. The TCV7106FN contains high-speed and low-on-resistance power MOSFETs for the main switch and has switchable operation mode, synchronous and non-synchronous. So the TCV7106FN can achieve high efficiency in the large load current range.

Features

- Enables up to 2.5A (@ $V_{IN} = 5V$) / 2A (@ $V_{IN} = 3.3V$) of load current (I_{OUT}) with a minimum of external components.
- High efficiency: $\eta = 95\%$ (typ.)
(synchronous mode @ $V_{IN} = 5V$, $V_{OUT} = 3.3V$, $I_{OUT} = 0.7A$)
- High efficiency in the large load current range is realized because of switchable operation mode, synchronous and non-synchronous.
- Operating voltage range: $V_{IN} = 2.7V$ to $5.6V$
- Low ON-resistance: $R_{DS(ON)} = 0.18\Omega$ (high side) / 0.12Ω (low-side) typical (@ $V_{IN} = 5V$, $T_j = 25^\circ C$)
- Oscillation frequency: $f_{OSC} = 550kHz$ (typ.)
- Feedback voltage: $V_{FB} = 0.8V \pm 1\%$ (@ $T_j = 0$ to $85^\circ C$)
- Uses internal phase compensation to achieve high efficiency with a minimum of external components.
- Allows the use of a small surface-mount ceramic capacitor as an output filter capacitor.
- Housed in a small surface-mount package (PS-8) with a low thermal resistance.

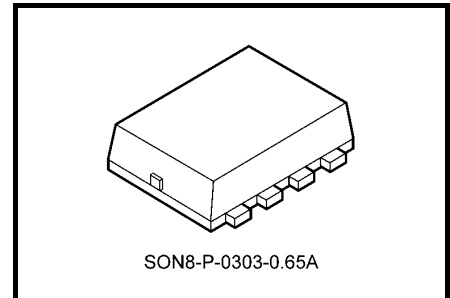

Weight: 0.017 g (typ.)

Part Marking

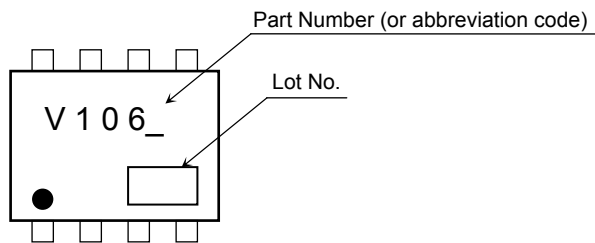

The dot (•) on the top surface indicates pin 1.

Pin Assignment

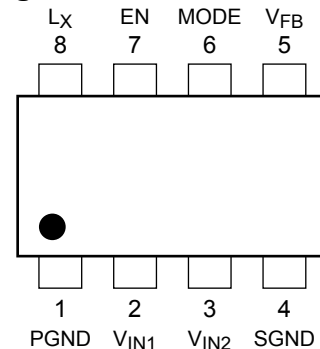

The lot number consists of three digits. The first digit represents the last digit of the year of manufacture, and the following two digits indicates the week of manufacture between 01 and either 52 or 53.

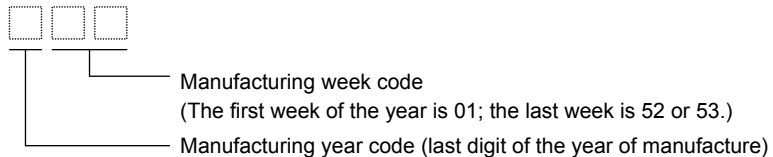

The underscore "_" after a part number shows the addition of the Feedback pin voltage detection.

This product has a MOS structure and is sensitive to electrostatic discharge. Handle with care.

The product(s) in this document ("Product") contain functions intended to protect the Product from temporary small overloads such as minor short-term overcurrent, or overheating. The protective functions do not necessarily protect Product under all circumstances. When incorporating Product into your system, please design the system to avoid such overloads upon the Product, and to shut down or otherwise relieve the Product of such overload conditions immediately upon occurrence. For details, please refer to the notes appearing below in this document and other documents referenced in this document.

Ordering Information

Part Number	Shipping
TCV7106FN (TE85L, F)	Embossed tape (3000 units per reel)

Block Diagram

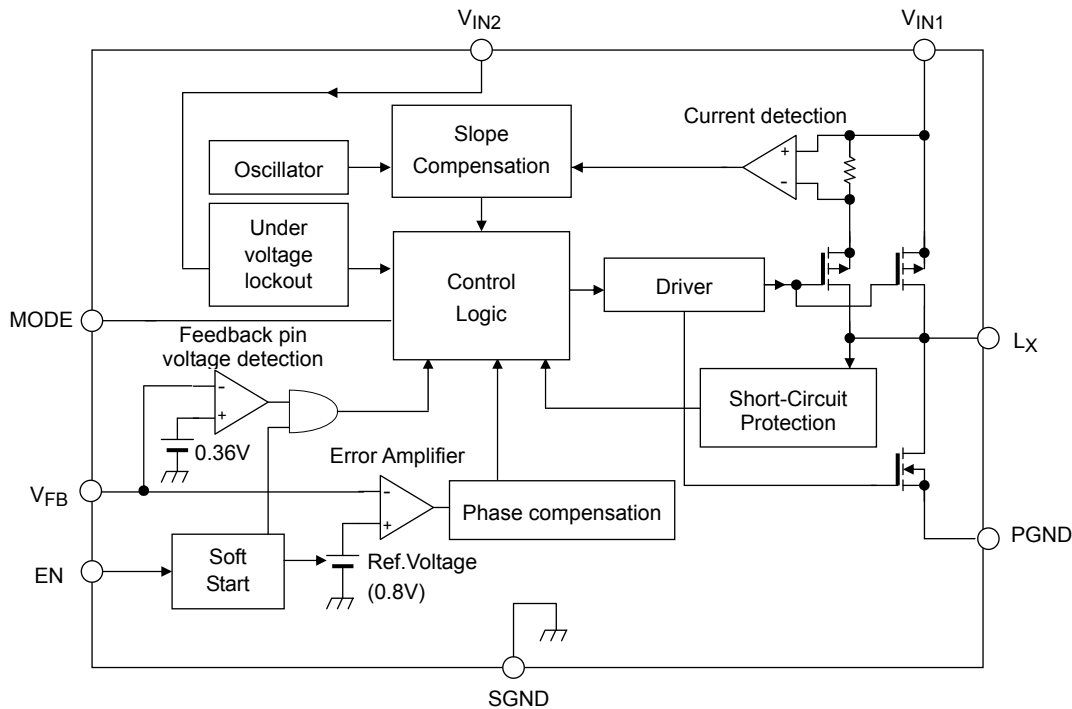

Pin Description

Pin No.	Symbol	Description
1	PGND	Ground pin for the output section
2	V _{IN1}	Input pin for the output section This pin is placed in the standby state if V _{EN} = L. Standby current is 10μA or less.
3	V _{IN2}	Input pin for the control section This pin is placed in the standby state if V _{EN} = L. Standby current is 10μA or less.
4	SGND	Ground pin for the control section
5	V _{FB}	Feedback pin This input is fed into an internal error amplifier with a reference voltage of 0.8V (typ.).
6	MODE	Mode select pin When EN ≥ 1.5V (@ V _{IN} = 5V), the synchronous rectifier type is applied and the internal low-side FET is allowed to operate. Thus TCV7106FN operates in PWM mode. When EN ≤ 0.5V (@ V _{IN} = 5V), the non-synchronous rectifier type is applied and the internal low-side FET is not allowed to operate. The Schottky barrier diode should be connected between PGND and L _X pins This pin is pulled up at 1.2μA (typ.) in operation.
7	EN	Enable pin When EN ≥ 1.5V (@ V _{IN} = 5V), the internal circuitry is allowed to operate and thus enable the switching operation of the output section. When EN ≤ 0.5V (@ V _{IN} = 5V), the internal circuitry is disabled, putting the TCV7106FN in Standby mode. This pin has an internal pull-down resistor of approx. 500kΩ.
8	L _X	Switch pin This pin is connected to high-side P-channel MOSFET and low-side N-channel MOSFET.

Absolute Maximum Ratings (Ta = 25°C) (Note)

Characteristics	Symbol	Rating	Unit
Input pin voltage for the output section (Note 1)	V _{IN1}	-0.3 to 7	V
Input pin voltage for the control section (Note 1)	V _{IN2}	-0.3 to 7	V
Feedback pin voltage (Note 1)	V _{FB}	-0.3 to 7	V
Enable pin voltage (Note 1)	V _{EN}	-0.3 to 7	V
Mode select pin voltage (Note 1)	V _{MODE}	-0.3 to 7	V
V _{EN} - V _{IN2} voltage difference	V _{EN} -V _{IN2}	V _{EN} - V _{IN2} < 0.3	V
V _{MODE} - V _{IN2} voltage difference	V _{MODE} -V _{IN2}	V _{MODE} - V _{IN2} < 0.3	V
Switch pin voltage (Note 2)	V _{LX}	-0.3 to 7	V
Switch pin current	I _{LX}	±2.9	A
Power dissipation (Note 3)	P _D	0.9	W
Operating junction temperature	T _{jopr}	-40 to 125	°C
Junction temperature (Note 4)	T _j	150	°C
Storage temperature	T _{stg}	-55 to 150	°C

Thermal Resistance Characteristics

Characteristics	Symbol	Max	Unit
Thermal resistance, junction to ambient	R _{th(j-a)}	110.2 (Note 3)	°C/W

Note: Using continuously under heavy loads (e.g. the application of high temperature/current/voltage and the significant change in temperature, etc.) may cause this product to decrease in the reliability significantly even if the operating conditions (i.e. operating temperature/current/voltage, etc.) are within the absolute maximum ratings and the operating ranges.

Please design the appropriate reliability upon reviewing the Toshiba Semiconductor Reliability Handbook ("Handling Precautions"/"Derating Concept and Methods") and individual reliability data (i.e. reliability test report and estimated failure rate, etc)

Note 1: Using this product continuously may cause a decrease in the reliability significantly even if the operating conditions are within the absolute maximum ratings. Set each pin voltage less than 5.6V taking into consideration the derating.

Note 2: The switch pin voltage (V_{LX}) doesn't include the peak voltage generated by TCV7106FN's switching. A negative voltage generated in dead time is permitted among the switch pin current (I_{LX}).

Note 3:

Single-sided glass epoxy board

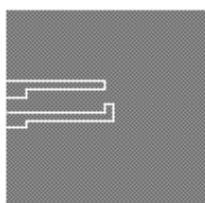

FR-4
25.4 × 25.4 × 0.8
(Unit: mm)

Note 4: The TCV7106FN may enter into thermal shutdown at the rated maximum junction temperature. Thermal design is required to ensure that the rated maximum operating junction temperature, T_{jopr}, will not be exceeded.

Electrical Characteristics ($T_j = 25^\circ\text{C}$, $V_{IN1} = V_{IN2} = 2.7\text{V to } 5.6\text{V}$, unless otherwise specified)

Characteristics		Symbol	Test Condition	Min	Typ.	Max	Unit
Operating input voltage		$V_{IN}(\text{OPR})$	—	2.7	—	5.6	V
Operating current		I_{IN}	$V_{IN1} = V_{IN2} = V_{EN} = V_{FB} = 5\text{V}$ $V_{\text{MODE}} = 5\text{V}$	—	450	680	μA
Output voltage range		$V_{\text{OUT}}(\text{OPR})$	$V_{EN} = V_{IN1} = V_{IN2}$	0.8	—	—	V
Standby current		$I_{IN}(\text{STBY}1)$	$V_{IN1} = V_{IN2} = 5\text{V}$, $V_{EN} = 0\text{V}$ $V_{FB} = 0.8\text{V}$	—	—	10	μA
		$I_{IN}(\text{STBY}2)$	$V_{IN1} = V_{IN2} = 3.3\text{V}$, $V_{EN} = 0\text{V}$ $V_{FB} = 0.8\text{V}$	—	—	10	
High-side switch leakage current		$I_{\text{LEAK}}(\text{H})$	$V_{IN1} = V_{IN2} = 5\text{V}$, $V_{EN} = 0\text{V}$ $V_{FB} = 0.8\text{V}$, $V_{\text{LX}} = 0\text{V}$	—	—	10	μA
EN threshold voltage		$V_{IH}(\text{EN})1$	$V_{IN1} = V_{IN2} = 5\text{V}$	1.5	—	—	V
		$V_{IH}(\text{EN})2$	$V_{IN1} = V_{IN2} = 3.3\text{V}$	1.5	—	—	
		$V_{IL}(\text{EN})1$	$V_{IN1} = V_{IN2} = 5\text{V}$	—	—	0.5	
		$V_{IL}(\text{EN})2$	$V_{IN1} = V_{IN2} = 3.3\text{V}$	—	—	0.5	
EN input current		$I_{IH}(\text{EN})1$	$V_{IN1} = V_{IN2} = 5\text{V}$, $V_{EN} = 5\text{V}$	6	—	13	μA
		$I_{IH}(\text{EN})2$	$V_{IN1} = V_{IN2} = 3.3\text{V}$, $V_{EN} = 3.3\text{V}$	4	—	9	
MODE threshold voltage		$V_{IH}(\text{MODE})$	$V_{IN1} = V_{IN2} = 5\text{V}$	1.5	—	—	V
		$V_{IL}(\text{MODE})$	$V_{IN1} = V_{IN2} = 5\text{V}$	—	—	0.5	
MODE input current		$I_{IH}(\text{MODE})$	$V_{IN1} = V_{IN2} = 5\text{V}$, $V_{EN} = 5\text{V}$	—	-1.2	-2.5	μA
V_{FB} input voltage		V_{FB1}	$V_{IN1} = V_{IN2} = 5\text{V}$, $V_{EN} = 5\text{V}$ $T_j = 0 \text{ to } 85^\circ\text{C}$	0.792	0.8	0.808	V
		V_{FB2}	$V_{IN1} = V_{IN2} = 3.3\text{V}$, $V_{EN} = 3.3\text{V}$ $T_j = 0 \text{ to } 85^\circ\text{C}$	0.792	0.8	0.808	
V_{FB} input current		I_{FB}	$V_{IN1} = V_{IN2} = 2.7\text{V to } 5.6\text{V}$, $V_{FB} = V_{IN2}$	-1	—	1	μA
High-side switch on-state resistance		$R_{\text{DS(ON)}(\text{H})1}$	$V_{IN1} = V_{IN2} = 5\text{V}$, $V_{EN} = 5\text{V}$ $I_{\text{LX}} = -1\text{A}$	—	0.18	—	Ω
		$R_{\text{DS(ON)}(\text{H})2}$	$V_{IN1} = V_{IN2} = 3.3\text{V}$, $V_{EN} = 3.3\text{V}$ $I_{\text{LX}} = -1\text{A}$	—	0.21	—	
		$R_{\text{DS(ON)}(\text{H})3}$	$V_{IN1} = V_{IN2} = 5\text{V}$, $V_{EN} = 5\text{V}$ $I_{\text{LX}} = -0.1\text{A}$, $T_j = -40 \text{ to } 85^\circ\text{C}$	—	—	0.25	
		$R_{\text{DS(ON)}(\text{H})4}$	$V_{IN1} = V_{IN2} = 3.3\text{V}$, $V_{EN} = 3.3\text{V}$ $I_{\text{LX}} = -0.1\text{A}$, $T_j = -40 \text{ to } 85^\circ\text{C}$	—	—	0.3	
Low-side switch on-state resistance		$R_{\text{DS(ON)}(\text{L})1}$	$V_{IN1} = V_{IN2} = 5\text{V}$, $V_{EN} = 5\text{V}$ $I_{\text{LX}} = -1\text{A}$	—	0.12	—	Ω
		$R_{\text{DS(ON)}(\text{L})2}$	$V_{IN1} = V_{IN2} = 3.3\text{V}$, $V_{EN} = 3.3\text{V}$ $I_{\text{LX}} = -1\text{A}$	—	0.14	—	
		$R_{\text{DS(ON)}(\text{L})3}$	$V_{IN1} = V_{IN2} = 5\text{V}$, $V_{EN} = 5\text{V}$ $I_{\text{LX}} = -0.1\text{A}$, $T_j = -40 \text{ to } 85^\circ\text{C}$	—	—	0.18	
		$R_{\text{DS(ON)}(\text{L})4}$	$V_{IN1} = V_{IN2} = 3.3\text{V}$, $V_{EN} = 3.3\text{V}$ $I_{\text{LX}} = -0.1\text{A}$, $T_j = -40 \text{ to } 85^\circ\text{C}$	—	—	0.2	
Oscillation frequency		f_{OSC}	$V_{IN1} = V_{IN2} = V_{EN} = 5\text{V}$	450	550	650	kHz
Internal soft-start time		t_{SS}	$V_{IN1} = V_{IN2} = 5\text{V}$, $I_{\text{OUT}} = 0\text{A}$, Measured between 0% and 90% points at V_{OUT} .	3	4.5	6	ms
High-side switch duty cycle		D_{max}	$V_{IN1} = V_{IN2} = 2.7\text{V to } 5.6\text{V}$	—	—	100	%
Thermal shutdown (TSD)	Detection temperature	T_{SD}	$V_{IN1} = V_{IN2} = 5\text{V}$	—	150	—	$^\circ\text{C}$
	Hysteresis	ΔT_{SD}	$V_{IN1} = V_{IN2} = 5\text{V}$	—	15	—	
Undervoltage lockout (UVLO)	Detection voltage	V_{UV}	$V_{EN} = V_{IN1} = V_{IN2}$	2.3	2.45	2.6	V
	Recovery voltage	V_{UVR}	$V_{EN} = V_{IN1} = V_{IN2}$	2.4	2.55	2.7	
	Hysteresis	ΔV_{UV}	$V_{EN} = V_{IN1} = V_{IN2}$	—	0.1	—	
I_{LX} current limit		$I_{\text{LIM}1}$	$V_{IN1} = V_{IN2} = 4.3\text{V}$, $V_{\text{OUT}} = 2\text{V}$	2.7	3.3	—	A
		$I_{\text{LIM}2}$	$V_{IN1} = V_{IN2} = 3.3\text{V}$, $V_{\text{OUT}} = 2\text{V}$	2.3	2.9	—	
Feedback pin detection voltage		V_{OLD}	$V_{EN} = V_{IN1} = V_{IN2}$	—	0.36	—	V

Note on Electrical Characteristics

The test condition $T_j = 25^\circ\text{C}$ means a state where any drifts in electrical characteristics incurred by an increase in the chip's junction temperature can be ignored during pulse testing.

Application Circuit Example

Figure 1 shows a typical application circuit using a low-ESR electrolytic or ceramic capacitor for C_{OUT} .

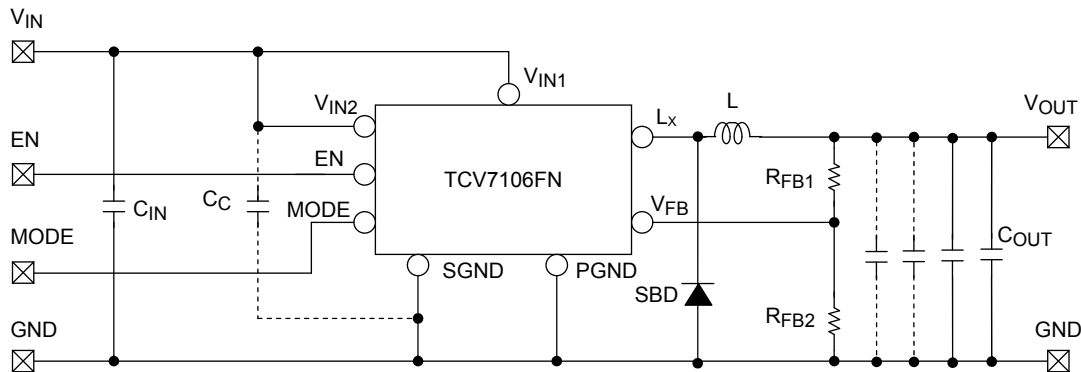

Figure 1 TCV7106FN Application Circuit Example

Component values (reference value@ $V_{IN} = 5\text{V}$, $V_{OUT} = 3.3\text{V}$, $T_a = 25^\circ\text{C}$)

C_{IN} : Input filter capacitor = $10\mu\text{F}$

(ceramic capacitor: GRM21BB30J106K manufactured by Murata Manufacturing Co., Ltd, C2012X5R1C106M manufactured by TDK-EPC Corporation.)

C_{OUT} : Output filter capacitor = $10\mu\text{F}$

(ceramic capacitor: GRM21BB30J106K manufactured by Murata Manufacturing Co., Ltd, C2012X5R1C106M manufactured by TDK-EPC Corporation.)

R_{FB1} : Output voltage setting resistor = $7.5\text{k}\Omega$

R_{FB2} : Output voltage setting resistor = $2.4\text{k}\Omega$

L: Inductor = $4.7\mu\text{H}$ (CLF7045T-4R7N manufactured by TDK-EPC Corporation, D63CB #A916CY-4R7M manufactured by TOKO, INC.)

SBD: Low-side Schottky barrier diode (Schottky barrier diode: CRS30I30A manufactured by Toshiba Corporation)

C_C is a decoupling capacitor of Input pin for the control section.

(Connect it when the circuit operation is unstable due to the board layout or a feature of the C_{IN} .)

When merely synchronous mode (MODE=H) is applied, the SBD can be leaved out.

Examples of Component Values (For Reference Only)

Output Voltage Setting V_{OUT}	Inductance L	Input Capacitance C_{IN}	Output Capacitance C_{OUT}	Feedback Resistor R_{FB1}	Feedback Resistor R_{FB2}
1.0 V	$4.7\mu\text{H}$	$10\mu\text{F}$	$40\mu\text{F}$	$7.5\text{k}\Omega$	$30\text{k}\Omega$
1.2 V	$4.7\mu\text{H}$	$10\mu\text{F}$	$30\mu\text{F}$	$7.5\text{k}\Omega$	$15\text{k}\Omega$
1.51 V	$4.7\mu\text{H}$	$10\mu\text{F}$	$30\mu\text{F}$	$16\text{k}\Omega$	$18\text{k}\Omega$
1.8 V	$4.7\mu\text{H}$	$10\mu\text{F}$	$30\mu\text{F}$	$15\text{k}\Omega$	$12\text{k}\Omega$
2.5 V	$4.7\mu\text{H}$	$10\mu\text{F}$	$20\mu\text{F}$	$5.1\text{k}\Omega$	$2.4\text{k}\Omega$
3.3 V	$4.7\mu\text{H}$	$10\mu\text{F}$	$20\mu\text{F}$	$7.5\text{k}\Omega$	$2.4\text{k}\Omega$

Component values need to be adjusted, depending on the TCV7106FN's I/O conditions and the board layout.

Application Notes

Inductor Selection

The inductance required for inductor L can be calculated as follows:

$$L = \frac{V_{IN} - V_{OUT}}{f_{OSC} \cdot \Delta I_L} \cdot \frac{V_{OUT}}{V_{IN}} \dots\dots\dots(1)$$

V_{IN} : Input voltage (V)
 V_{OUT} : Output voltage (V)
 f_{OSC} : Oscillation frequency = 550 kHz (typ.)
 ΔI_L : Inductor ripple current (A)

*: Generally, ΔI_L should be set to approximately 25% of the maximum output current. Since the maximum output current of the TCV7106FN is 2.5A, ΔI_L should be 0.6A or so. The inductor should have a current rating greater than the peak output current of 2.8A. If the inductor current rating is exceeded, the inductor becomes saturated, leading to an unstable DC-DC converter operation.

When $V_{IN} = 5V$ and $V_{OUT} = 3.3V$, the required inductance can be calculated as follows. Be sure to select an appropriate inductor, taking the input voltage range into account.

$$L = \frac{V_{IN} - V_{OUT}}{f_{OSC} \cdot \Delta I_L} \cdot \frac{V_{OUT}}{V_{IN}}$$

$$= \frac{5V - 3.3V}{550kHz \cdot 0.6A} \cdot \frac{3.3V}{5V}$$

$$= 3.4\mu H$$

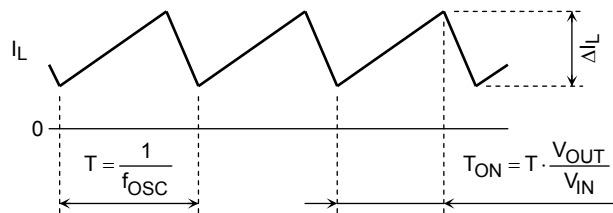

Figure 2 Inductor Current Waveform

Setting the Output Voltage

A resistive voltage divider is connected as shown in Figure 3 to set the output voltage; it is given by Equation 2 based on the reference voltage of the error amplifier (0.8V typ.), which is connected to the Feedback pin, VFB. RFB1 should be up to 30kΩ or so, because an extremely large-value RFB1 incurs a delay due to parasitic capacitance at the VFB pin. It is recommended that resistors with a precision of ±1% or higher be used for RFB1 and RFB2.

$$V_{OUT} = V_{FB} \cdot \left(1 + \frac{R_{FB1}}{R_{FB2}} \right)$$

$$= 0.8V \cdot \left(1 + \frac{R_{FB1}}{R_{FB2}} \right) \dots\dots\dots(2)$$

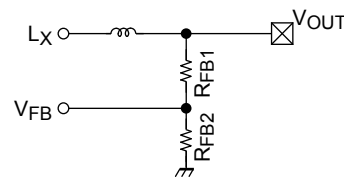

Figure 3 Output Voltage Setting Resistors

Rectifier Selection

If non-synchronous (MODE=L) is selected, Low side MOSFET is always turned off, and this product can be used as DC-DC converter of the non-synchronous method. While non-synchronous mode is applied, connect the Schottky barrier diode as a rectifier between the LX and PGND pins. It is recommended CRS30I30A or equivalent be used as Schottky barrier diode. Power loss of a Schottky barrier diode tends to increase due to an increased reverse current caused by the rise in ambient temperature and self-heating due to a supplied current. The rated current should therefore be derated to allow for such conditions in selecting an appropriate diode.

While fixed to synchronous mode (MODE=H), an external rectifier is not necessary.

Output Filter Capacitor Selection

Use a low-ESR electrolytic or ceramic capacitor as the output filter capacitor. Since a capacitor is generally sensitive to temperature, choose one with excellent temperature characteristics. When the output voltage exceeds 2V, the capacitance should be 20 μ F or greater for applications. Meanwhile 30 μ F or greater capacitance is desirable when the output voltage is less than 2V. The capacitance should be set to an optimal value that meets the system’s ripple voltage requirement and transient load response characteristics. The phase margin tends to decrease as the output voltage is getting low. Enlarge a capacitance for output flatness when phase margin is insufficient, or the transient load response characteristics cannot be satisfied. Since the ceramic capacitor has a very low ESR value, it helps reduce the output ripple voltage; however, because the ceramic capacitor provides less phase margin, it should be thoroughly evaluated.

Soft-Start Feature

The TCV7106FN has a soft-start feature. The soft-start time, t_{SS} , for V_{OUT} defaults to 4.5ms (typ.) internally. The soft-start feature is activated when the TCV7106FN exits the undervoltage lockout (UVLO) state after power-up and when the voltage at the EN pin has changed from logic low to logic high.

Mode Select Feature

The TCV7106FN operation mode is switchable: synchronous (MODE=H) and non-synchronous (MODE=L). While non-synchronous mode is applied, connect external SBD as a low side element.

The synchronous mode can achieve high efficiency at high load current. The non-synchronous mode can achieve higher efficiency than synchronous mode when the load current is less than 100mA; however, take into consideration the increase of the output ripple voltage. Switching function between synchronous and non-synchronous is possible at anytime, but fluctuation in output voltage occurs at the time of switching and it might be enlarged at low load current range where pulse-skip occurs. In that case a thorough evaluation is desirable to ascertain that the fluctuation range is within requirements.

Over Current Protection

The TCV7106FN has maximum current limiting. The TCV7106FN limits the ON time of high side switching transistor and decreases output voltage when the peak value of the Lx terminal current exceeds switching terminal peak current limitation $I_{LIM1} = 3.3A(\text{typ.}) @ V_{IN} = 4.3V / I_{LIM2} = 2.9A(\text{typ.}) @ V_{IN} = 3.3V$. When $V_{IN} \geq 4.3V$, The TCV7106FN can operate at $I_{OUT} = 2.5A(\text{max})$. Meanwhile, use it at $I_{OUT} = 2A(\text{max})$ when $V_{IN} < 4.3V$.

Feedback pin Voltage Detection

The TCV7106FN has the Feedback pin voltage detection. When the feedback pin voltage decrease and reaches $V_{OLD} = 0.36V$ (typ.), the TCV7106FN shuts off the power supply after 65 μ s(typ.) and suppresses the rise of the output voltage by ground fault of a feedback pin. When the decrease in the feedback pin voltage is detected when the overcurrent protection operates, the output voltage is stopped.

The output voltage is not stopped by the feedback pin voltage detection while a soft start function is operating. For this reason, the supply of the output voltage is begun by the soft start operation after an enable pin or the input voltage is turned on.

Undervoltage Lockout (UVLO)

The TCV7106FN has undervoltage lockout (UVLO) protection circuitry. The TCV7106FN does not provide output voltage (V_{OUT}) until the input voltage has reached $V_{UVR} = 2.55V$ (typ.). UVLO has hysteresis of 0.1V (typ.). After the switch turns on, if V_{IN2} drops below $V_{UV} = 2.45V$ (typ.), UVLO shuts off the switch at V_{OUT} .

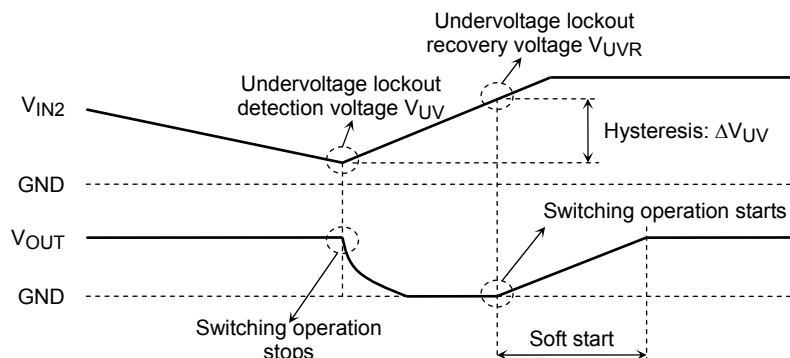

Figure 4 Undervoltage Lockout Operation

Thermal Shutdown (TSD)

The TCV7106FN provides thermal shutdown. When the junction temperature continues to rise and reaches $TSD = 150^{\circ}\text{C}$ (typ.), the TCV7106FN goes into thermal shutdown and shuts off the power supply. TSD has a hysteresis of about 15°C (typ.). The device is enabled again when the junction temperature has dropped by approximately 15°C from the TSD trip point. The device resumes the power supply when the soft-start circuit is activated upon recovery from TSD state.

Thermal shutdown is intended to protect the device against abnormal system conditions. It should be ensured that the TSD circuit will not be activated during normal operation of the system.

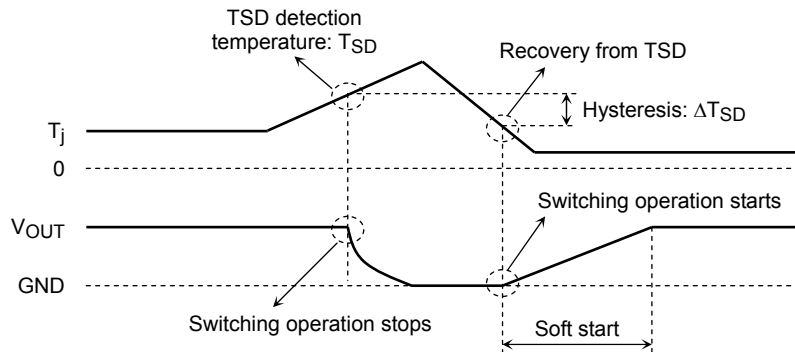
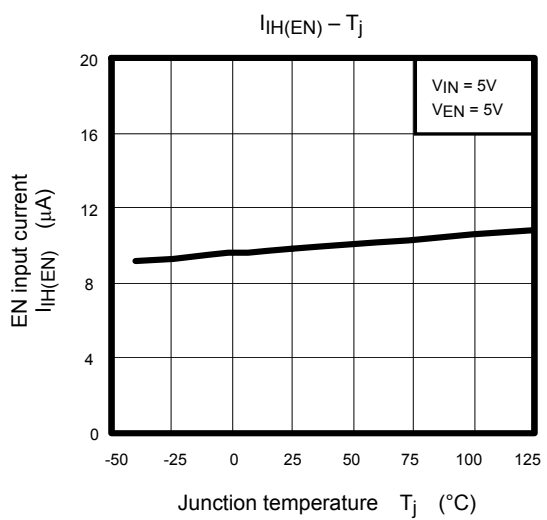
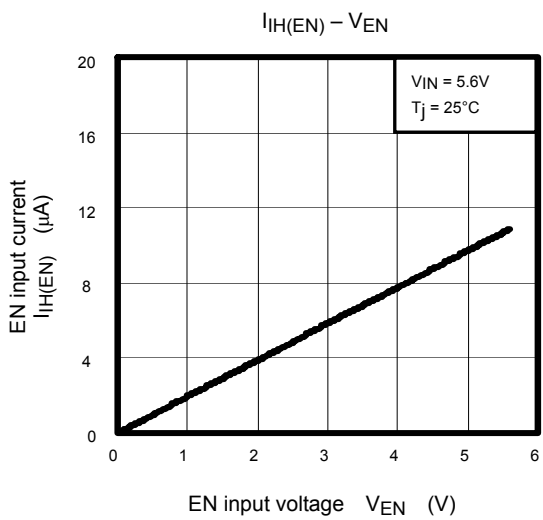
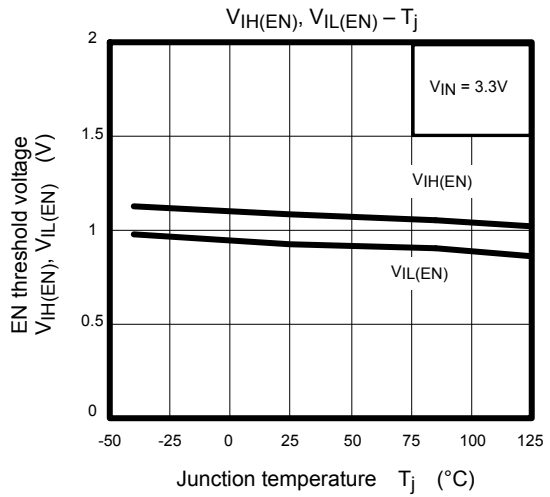
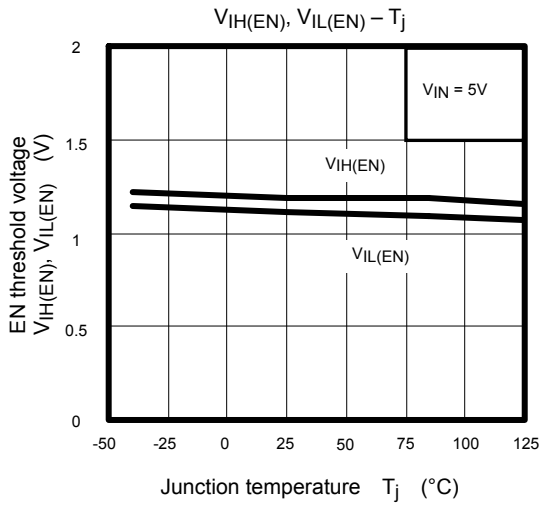
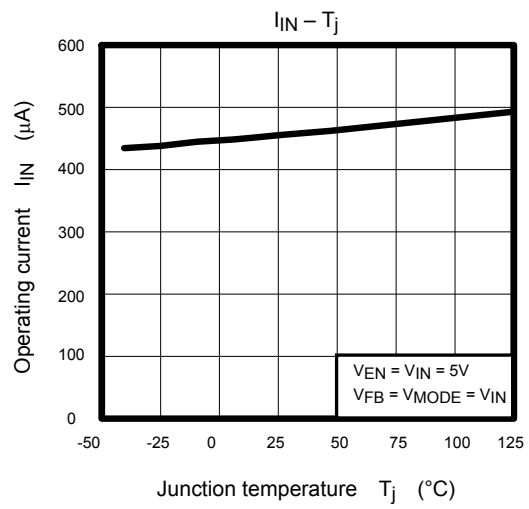
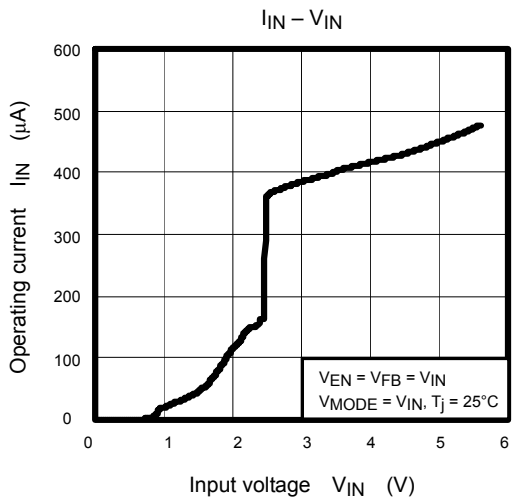

Figure 5 Thermal Shutdown Operation

Usage Precautions

- The input voltage, output voltage, output current and temperature conditions should be considered when selecting capacitors, inductors and resistors. These components should be evaluated on an actual system prototype for best selection.
- Parts of this product in the surrounding are examples of the representative, and the supply might become impossible. Please confirm latest information when using it.
- External components such as capacitors, inductors and resistors should be placed as close to the TCV7106FN as possible.
- The TCV7106FN has an ESD diode between the EN and V_{IN2} pins. The voltage between these pins should satisfy $V_{EN} - V_{IN2} < 0.3\text{V}$.
- C_{IN} should be connected as close to the PGND and V_{IN1} pins as possible. Operation might become unstable due to board layout. In that case, add a decoupling capacitor (C_C) of $0.1\ \mu\text{F}$ to $1\ \mu\text{F}$ between the SGND and V_{IN2} pins.
- The minimum programmable output voltage is 0.8V (typ.). If the difference between the input and output voltages is small, the output voltage might not be regulated accurately and fluctuate significantly.
- When TCV7106FN is in operation, a negative voltage is generated since regeneration current flows through the switch pin (LX). Even if the current flows through the low side parasitic diode during the dead time of switching transistor, operation is undisturbed so an external flywheel diode is unnecessary. If there is the possibility of an external negative voltage generation, add a diode for protection. While non-synchronous mode is applied, connect external Schottky barrier diode as a low side element.
- SGND pin is connected with the back of IC chip and serves as the heat radiation pin. Secure the area of a GND pattern as large as possible for greater of heat radiation.
- The overcurrent protection circuits in the Product are designed to temporarily protect Product from minor overcurrent of brief duration. When the overcurrent protective function in the Product activates, immediately cease application of overcurrent to Product. Improper usage of Product, such as application of current to Product exceeding the absolute maximum ratings, could cause the overcurrent protection circuit not to operate properly and/or damage Product permanently even before the protection circuit starts to operate.
- The thermal shutdown circuits in the Product are designed to temporarily protect Product from minor overheating of brief duration. When the overheating protective function in the Product activates, immediately correct the overheating situation. Improper usage of Product, such as the application of heat to Product exceeding the absolute maximum ratings, could cause the overheating protection circuit not to operate properly and/or damage Product permanently even before the protection circuit starts to operate.

Typical Performance Characteristics



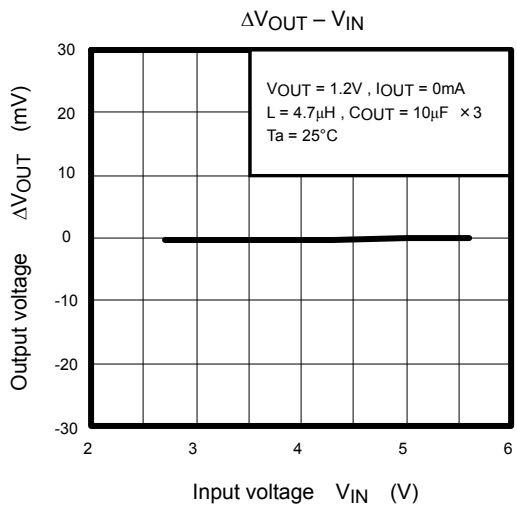
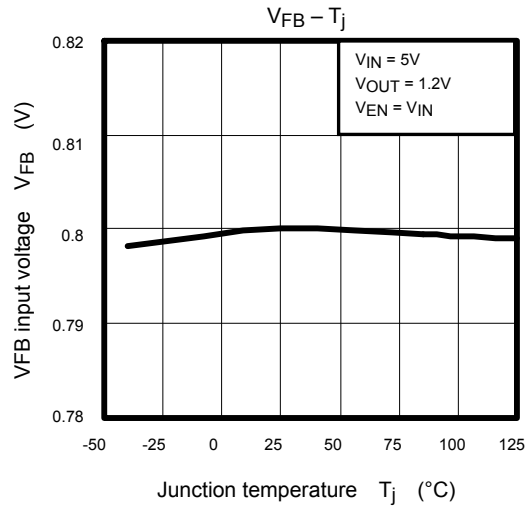
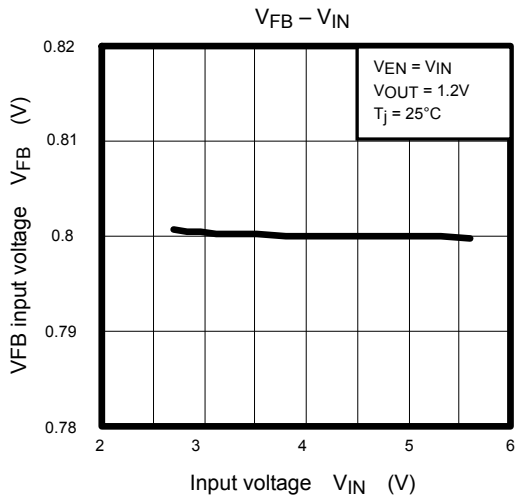
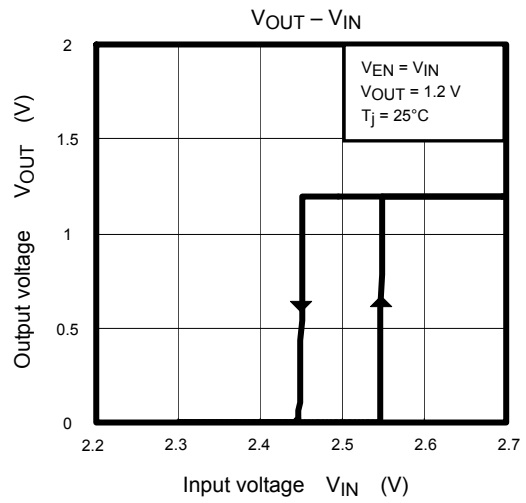
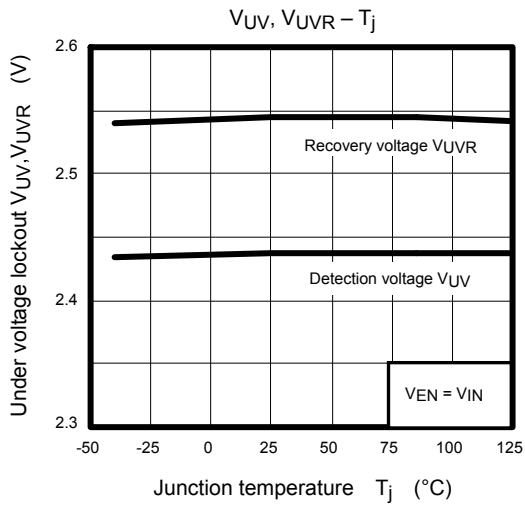

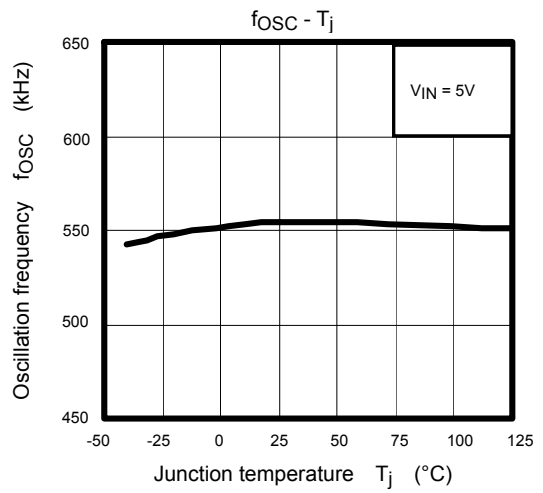
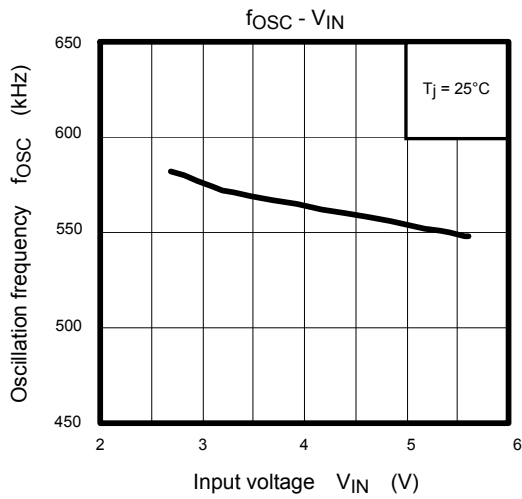

Startup Characteristics
(synchronous mode Soft-Start Time)

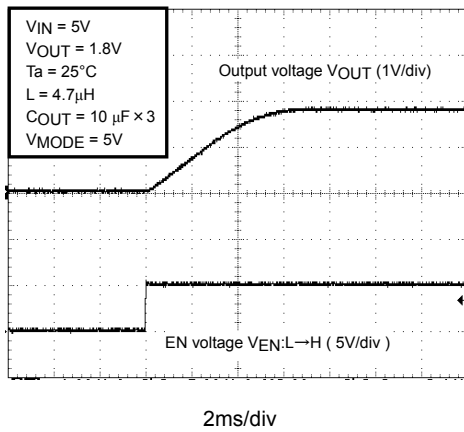

Startup Characteristics
(non-synchronous mode Soft-Start Time)

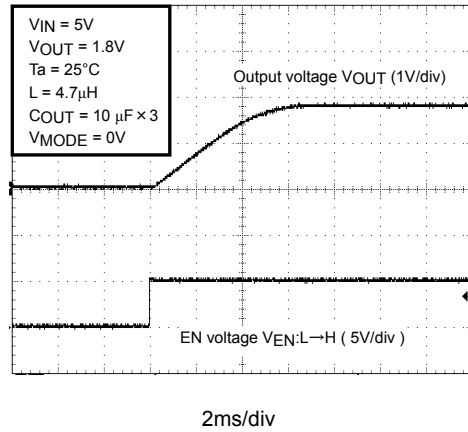

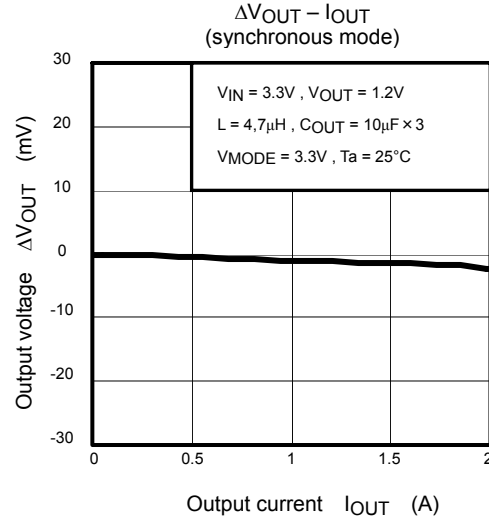
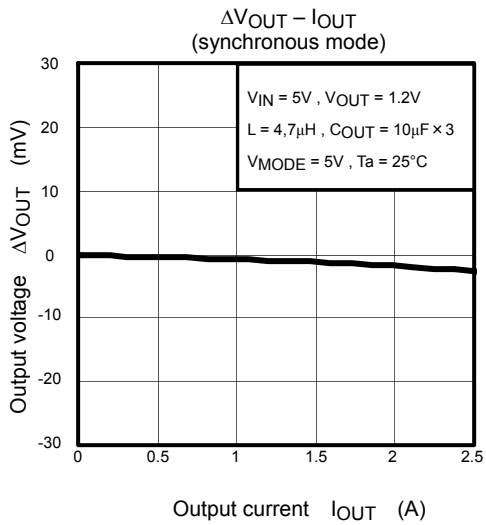
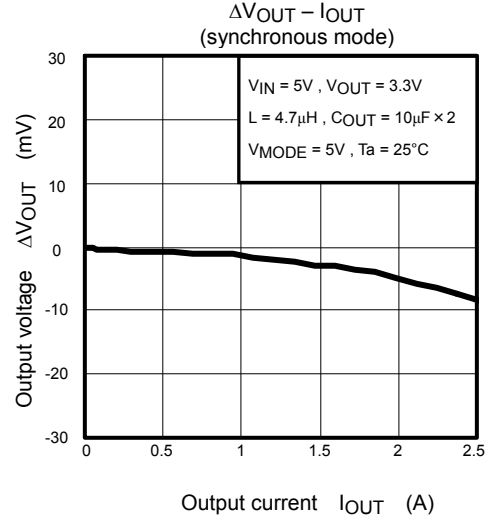
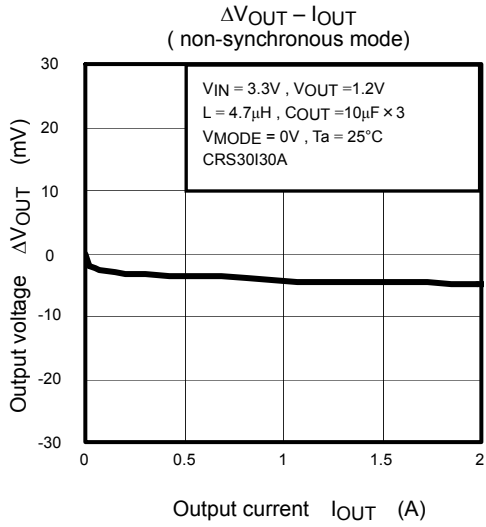
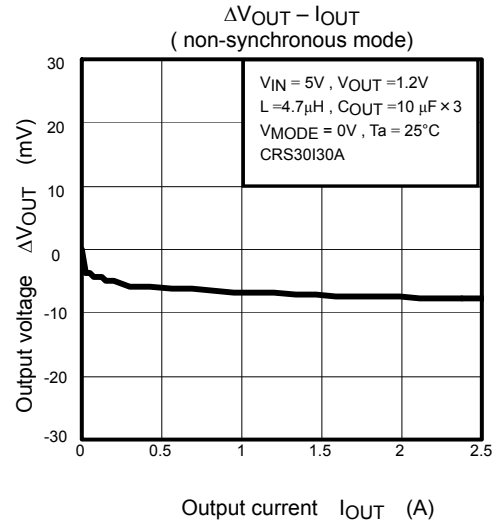
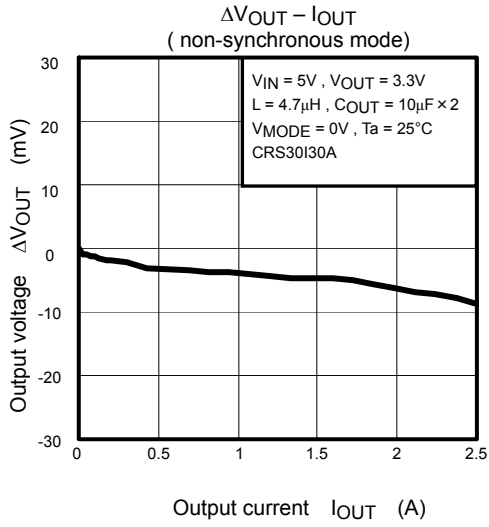

Overcurrent Protection
(non-synchronous mode)

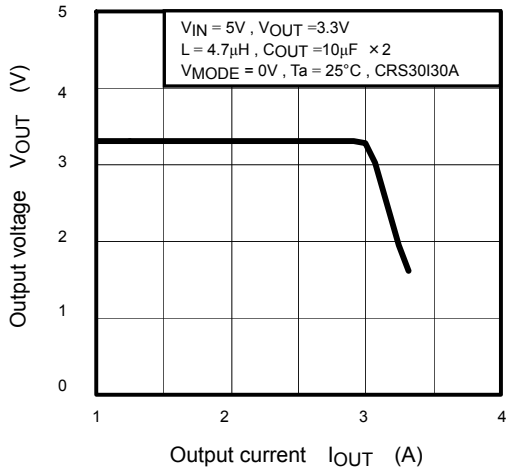

Overcurrent Protection
(non-synchronous mode)

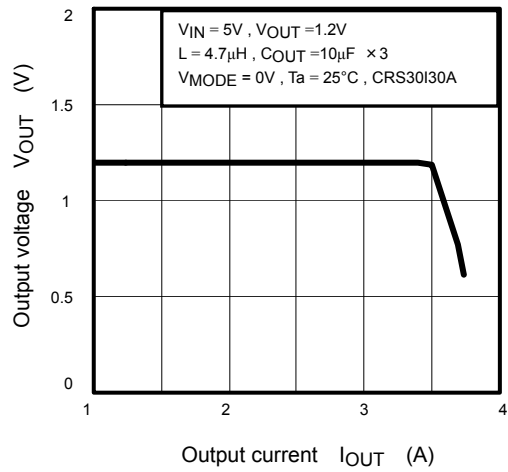

Overcurrent Protection
(non-synchronous mode)

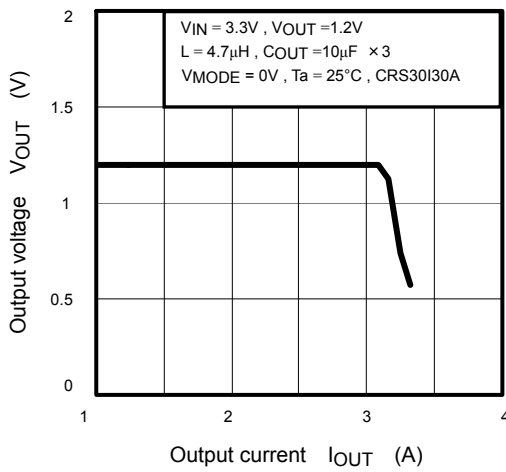

Overcurrent Protection
(synchronous mode)

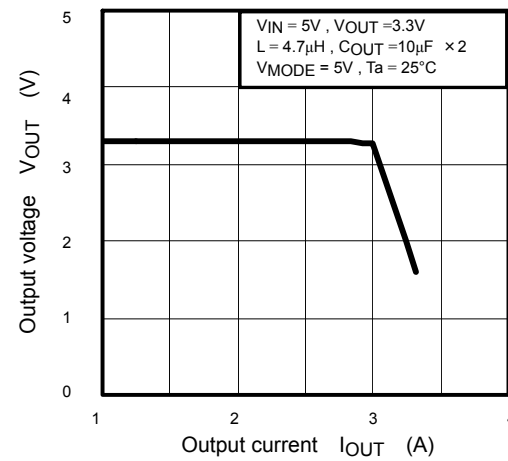

Overcurrent Protection
(synchronous mode)

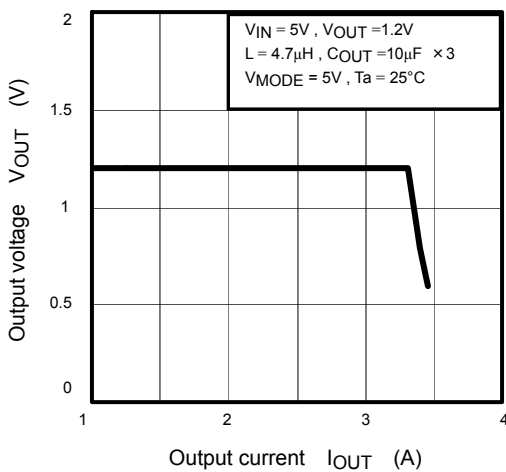

Overcurrent Protection
(synchronous mode)

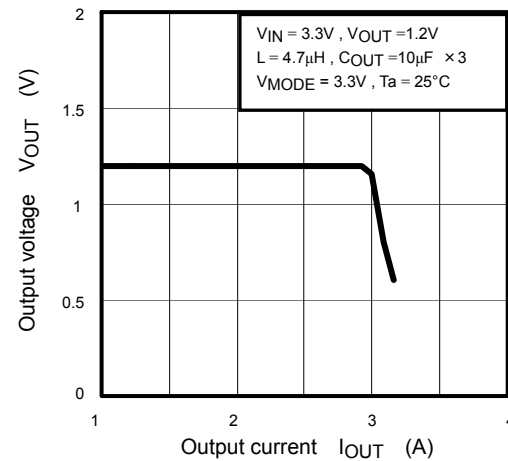

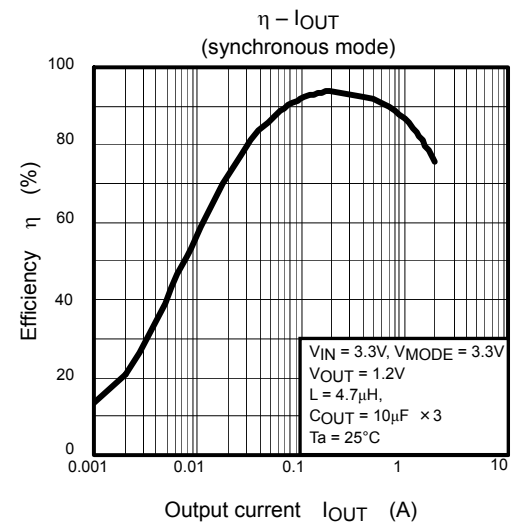
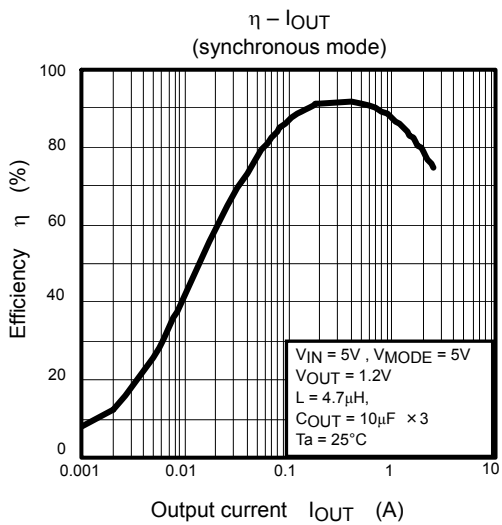
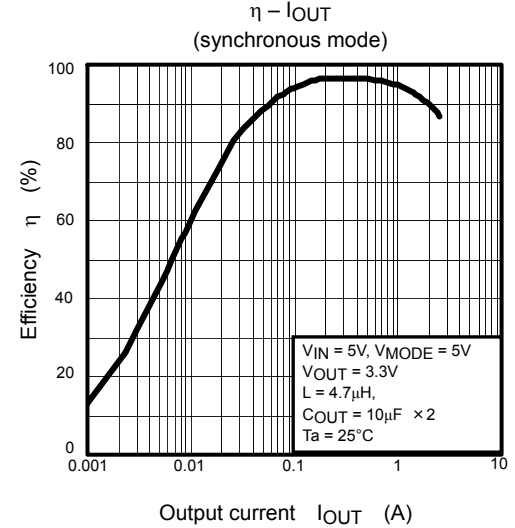
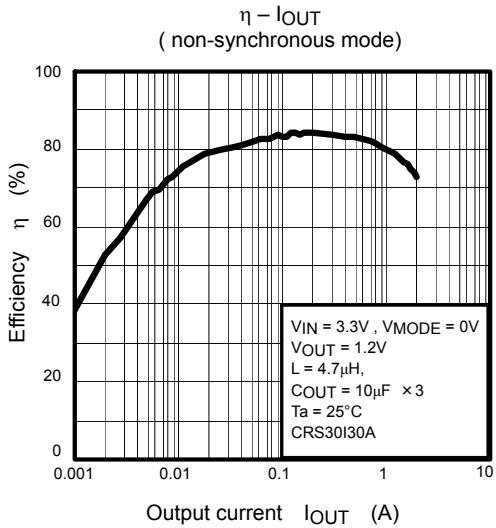
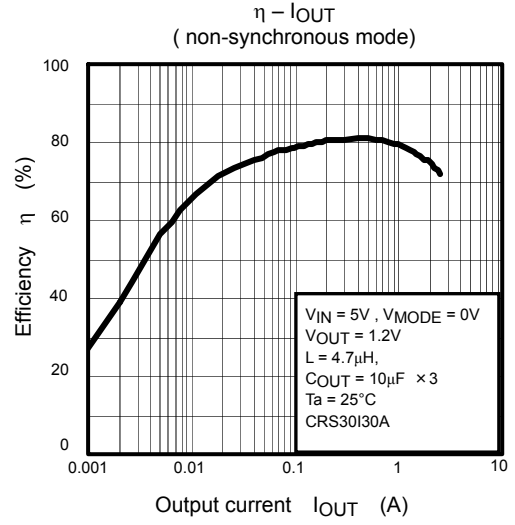
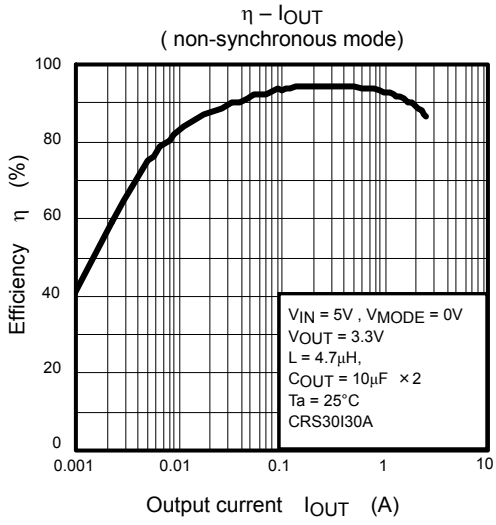

Load Response Characteristics
(synchronous mode)

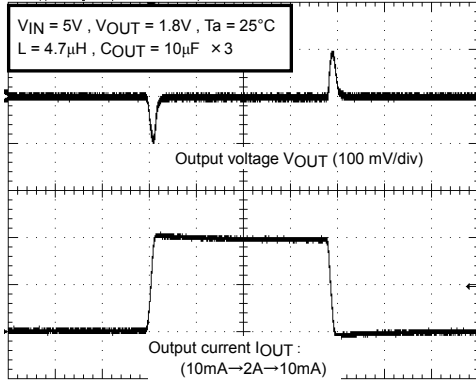

200 μs/div

Load Response Characteristics
(non-synchronous mode)

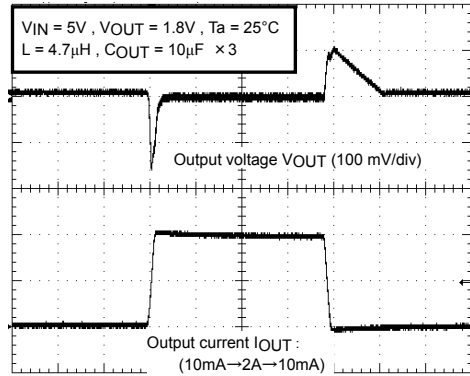

200 μs/div

Mode Switching IOUT=2A
(non-synchronous→synchronous→non-synchronous)

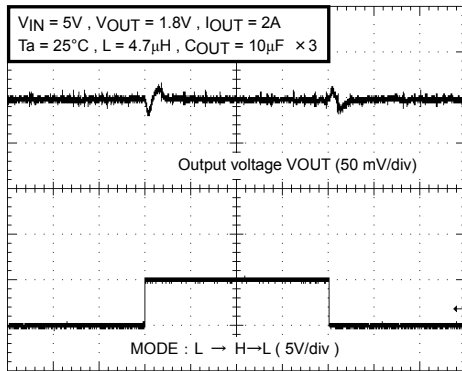

40 μs/div

Mode Switching IOUT=100mA
(non-synchronous→synchronous→non-synchronous)

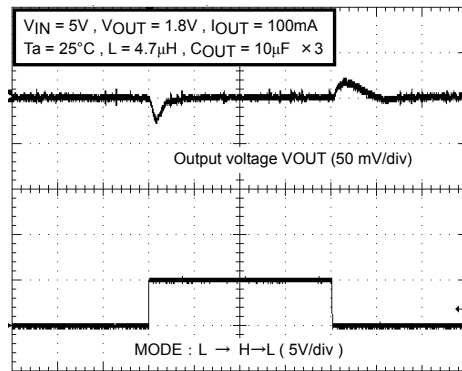

40 μs/div

Mode Switching IOUT=1.5mA
(non-synchronous→synchronous)

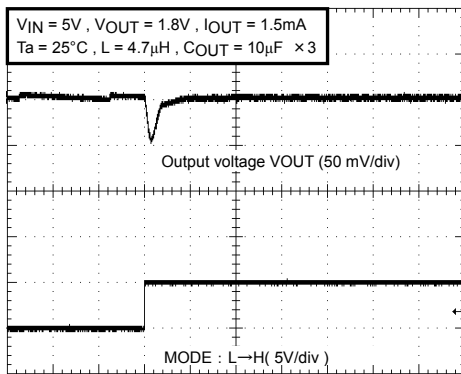

40 μs/div

Mode Switching IOUT=1.5mA
(synchronous→non-synchronous)

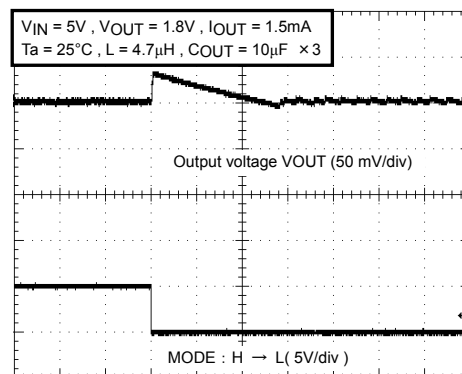

200 μs /div

Package Dimensions
SON8-P-0303-0.65A

Unit: mm

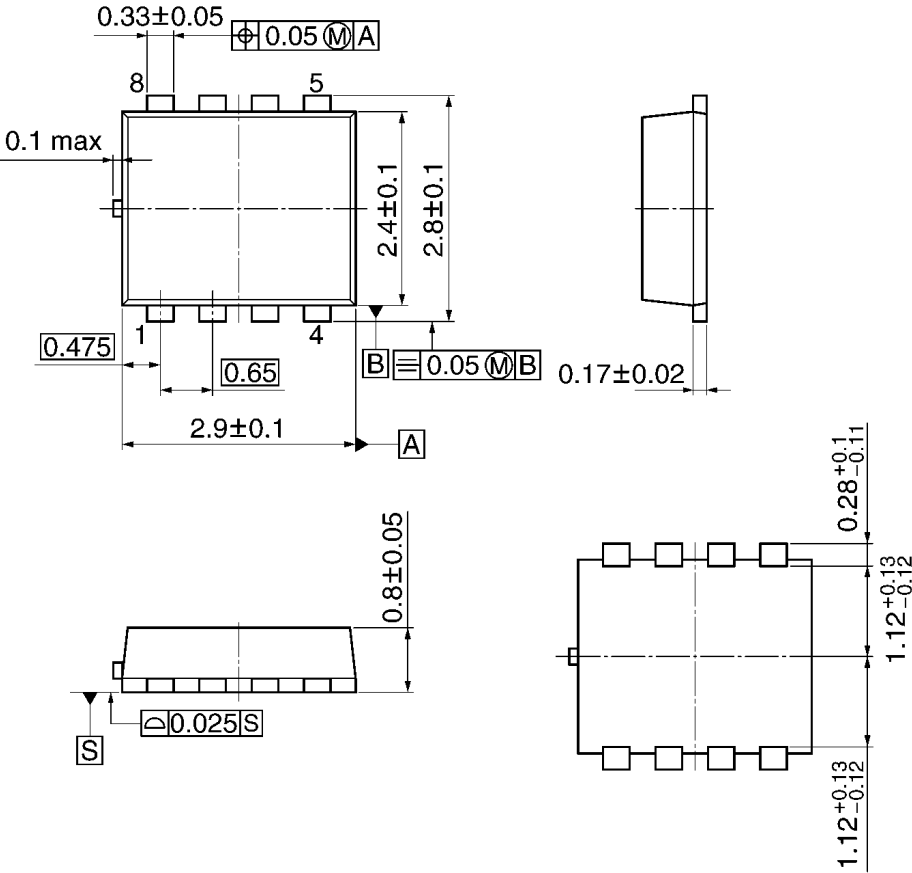

Weight: 0.017g (typ.)

RESTRICTIONS ON PRODUCT USE

- Toshiba Corporation, and its subsidiaries and affiliates (collectively "TOSHIBA"), reserve the right to make changes to the information in this document, and related hardware, software and systems (collectively "Product") without notice.
- This document and any information herein may not be reproduced without prior written permission from TOSHIBA. Even with TOSHIBA's written permission, reproduction is permissible only if reproduction is without alteration/omission.
- Though TOSHIBA works continually to improve Product's quality and reliability, Product can malfunction or fail. Customers are responsible for complying with safety standards and for providing adequate designs and safeguards for their hardware, software and systems which minimize risk and avoid situations in which a malfunction or failure of Product could cause loss of human life, bodily injury or damage to property, including data loss or corruption. Before customers use the Product, create designs including the Product, or incorporate the Product into their own applications, customers must also refer to and comply with (a) the latest versions of all relevant TOSHIBA information, including without limitation, this document, the specifications, the data sheets and application notes for Product and the precautions and conditions set forth in the "TOSHIBA Semiconductor Reliability Handbook" and (b) the instructions for the application with which the Product will be used with or for. Customers are solely responsible for all aspects of their own product design or applications, including but not limited to (a) determining the appropriateness of the use of this Product in such design or applications; (b) evaluating and determining the applicability of any information contained in this document, or in charts, diagrams, programs, algorithms, sample application circuits, or any other referenced documents; and (c) validating all operating parameters for such designs and applications. **TOSHIBA ASSUMES NO LIABILITY FOR CUSTOMERS' PRODUCT DESIGN OR APPLICATIONS.**
- Product is intended for use in general electronics applications (e.g., computers, personal equipment, office equipment, measuring equipment, industrial robots and home electronics appliances) or for specific applications as expressly stated in this document. Product is neither intended nor warranted for use in equipment or systems that require extraordinarily high levels of quality and/or reliability and/or a malfunction or failure of which may cause loss of human life, bodily injury, serious property damage or serious public impact ("Unintended Use"). Unintended Use includes, without limitation, equipment used in nuclear facilities, equipment used in the aerospace industry, medical equipment, equipment used for automobiles, trains, ships and other transportation, traffic signaling equipment, equipment used to control combustions or explosions, safety devices, elevators and escalators, devices related to electric power, and equipment used in finance-related fields. Do not use Product for Unintended Use unless specifically permitted in this document.
- Do not disassemble, analyze, reverse-engineer, alter, modify, translate or copy Product, whether in whole or in part.
- Product shall not be used for or incorporated into any products or systems whose manufacture, use, or sale is prohibited under any applicable laws or regulations.
- The information contained herein is presented only as guidance for Product use. No responsibility is assumed by TOSHIBA for any infringement of patents or any other intellectual property rights of third parties that may result from the use of Product. No license to any intellectual property right is granted by this document, whether express or implied, by estoppel or otherwise.
- **ABSENT A WRITTEN SIGNED AGREEMENT, EXCEPT AS PROVIDED IN THE RELEVANT TERMS AND CONDITIONS OF SALE FOR PRODUCT, AND TO THE MAXIMUM EXTENT ALLOWABLE BY LAW, TOSHIBA (1) ASSUMES NO LIABILITY WHATSOEVER, INCLUDING WITHOUT LIMITATION, INDIRECT, CONSEQUENTIAL, SPECIAL, OR INCIDENTAL DAMAGES OR LOSS, INCLUDING WITHOUT LIMITATION, LOSS OF PROFITS, LOSS OF OPPORTUNITIES, BUSINESS INTERRUPTION AND LOSS OF DATA, AND (2) DISCLAIMS ANY AND ALL EXPRESS OR IMPLIED WARRANTIES AND CONDITIONS RELATED TO SALE, USE OF PRODUCT, OR INFORMATION, INCLUDING WARRANTIES OR CONDITIONS OF MERCHANTABILITY, FITNESS FOR A PARTICULAR PURPOSE, ACCURACY OF INFORMATION, OR NONINFRINGEMENT.**
- Do not use or otherwise make available Product or related software or technology for any military purposes, including without limitation, for the design, development, use, stockpiling or manufacturing of nuclear, chemical, or biological weapons or missile technology products (mass destruction weapons). Product and related software and technology may be controlled under the Japanese Foreign Exchange and Foreign Trade Law and the U.S. Export Administration Regulations. Export and re-export of Product or related software or technology are strictly prohibited except in compliance with all applicable export laws and regulations.
- Please contact your TOSHIBA sales representative for details as to environmental matters such as the RoHS compatibility of Product. Please use Product in compliance with all applicable laws and regulations that regulate the inclusion or use of controlled substances, including without limitation, the EU RoHS Directive. TOSHIBA assumes no liability for damages or losses occurring as a result of noncompliance with applicable laws and regulations.