

Features

- 13 dB Gain at 2 GHz
- 14 dBm P1dB at 2 GHz
- 27 dBm OIP3 at 2 GHz
- MTTF > 100 Years
- Single Supply

Description

The AST11L, a power amplifier MMIC, has a high linearity, high gain, and high efficiency over a wide range of frequency, being suitable for use in both receiver and transmitter of telecommunication systems up to 3.5 GHz. The amplifier is available in an SOT-363 package and passes through the stringent DC, RF, and reliability tests.

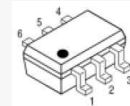

Package Style: SOT-363

Typical Performance

Parameters	Units	Typical			
		170 ~ 240 DVB-T(V band)	478 ~ 862 DVB-T(U band)	900	2000
Frequency	MHz				
Gain	dB	14	15	18	13
S11	dB	-8	-9	-13.5	-14
S22	dB	-11	-9	-12	-11
Output IP3 ¹⁾	dBm	16	18	24.5	27
Noise Figure	dB	1.8	1.8	1.2	1.3
Output P1dB	dBm	5	6.5	13	14
Current	mA	13	13	25	25
Device Voltage	V	5	5	3	3

1) OIP3 is measured with two tones at an output power of -5 dBm/tone separated by 1 MHz.

Application Circuit

- CDMA
- WCDMA
- DVB-T (V/U band)

Product Specifications

Parameters	Units	Min	Typ	Max
Testing Frequency	MHz		2000	
Gain	dB	12	13	
S11	dB		-14	
S22	dB		-11	
Output IP3	dBm	23	27	
Noise Figure	dB		1.3	1.5
Output P1dB	dBm	11	14	
Current	mA	14	25	40
Device Voltage	V		3	

Absolute Maximum Ratings

Parameters	Rating
Operating Case Temperature	-40 to +85°C
Storage Temperature	-40 to +150°C
Device Voltage	+5.5 V
Operating Junction Temperature	+150°C
Input RF Power (CW, 50ohm matched)*	22 dBm

* Please find the max. input power data from http://www.asb.co.kr/pdf/Maximum_Input_Power_Analysis.pdf

Pin Configuration

Pin No.	Function
1,2,4,5	GND
3	RF IN
6	RF OUT / Bias

Outline Drawing

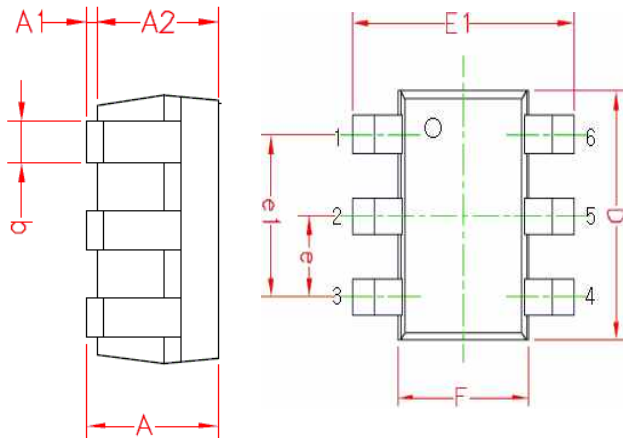

Symbols	Dimensions (In mm)		
	MIN	NOM	MAX
A	0.90	1.00	1.10
A1	0.025	0.062	0.10
A2	0.875	0.937	1.00
b	0.20	0.30	0.40
C	0.10	0.125	0.15
D	1.90	2.00	2.10
F	1.15	1.25	1.35
E1	2.00	2.10	2.20
e	--	0.65BSC	--
e1	--	1.30BSC	--
L	--	0.425REF	--

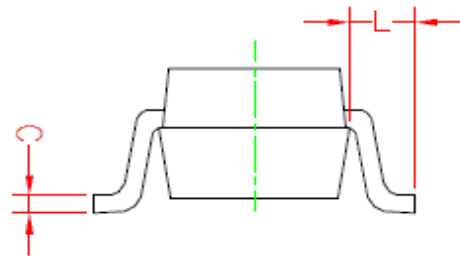

Pin NO.	Function	Pin NO.	Function.
1	GND	4	GND
2	GND	5	GND
3	RF IN	6	RF OUT / Bias

Mounting Recommendation (in mm)

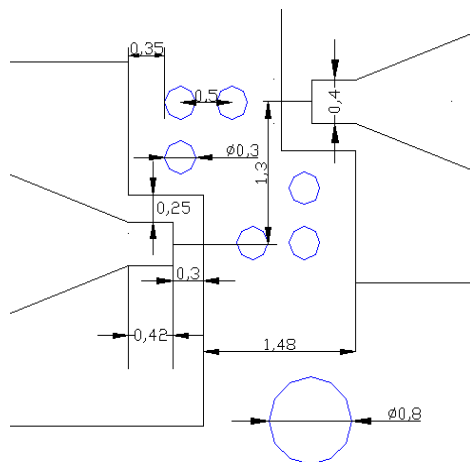

- Note:**
1. The number and size of ground via holes in a circuit board is critical for thermal and RF grounding considerations.
 2. We recommend that the ground via holes be placed on the bottom of lead pin 2 for better RF and thermal performance, as shown in the drawing at the left side.

Ordering Information

Part Number	Description
-------------	-------------

APPLICATION CIRCUIT

CDMA

824 ~ 894 MHz

+3 V

Frequency (MHz)	824~894
Magnitude S21 (dB)	18
Magnitude S11 (dB)	-13.5
Magnitude S22 (dB)	-12
Output P1dB (dBm)	13
Output IP3 ¹⁾ (dBm)	24.5
Noise Figure (dB)	1.2
Device Voltage (V)	3
Current (mA)	25

1) OIP3 is measured with two tones at an output power of -5 dBm/tone separated by 1 MHz.

Schematic

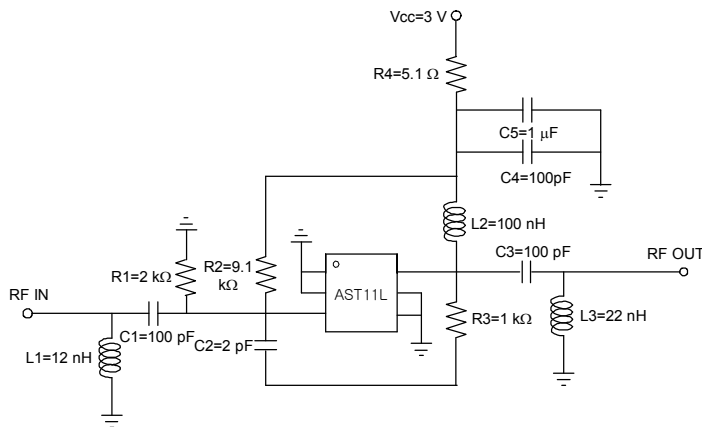

Board Layout (FR4, 40x40 mm², 0.8T)

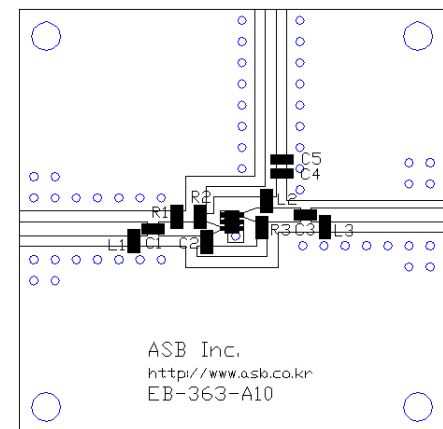

S-parameters & K-factor

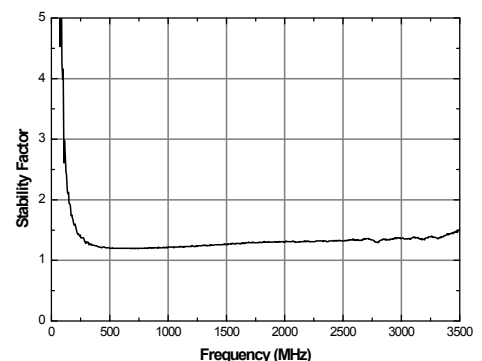
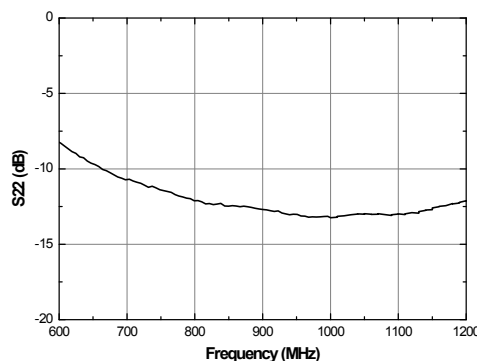
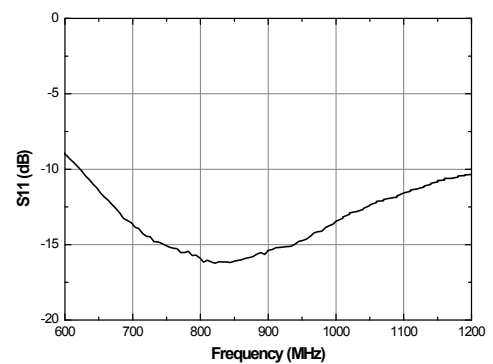
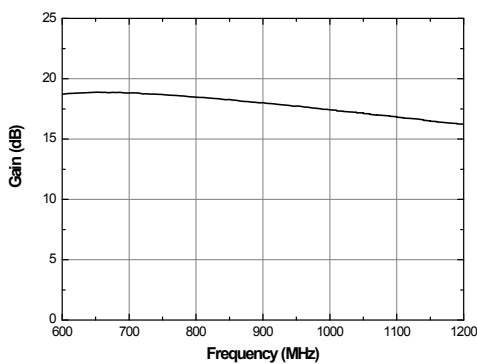

APPLICATION CIRCUIT

WCDMA

1920 ~ 2170 MHz

+3 V

Frequency (MHz)	1920~2170
Magnitude S21 (dB)	13
Magnitude S11 (dB)	-14
Magnitude S22 (dB)	-11
Output P1dB (dBm)	14
Output IP3 ¹⁾ (dBm)	27
Noise Figure (dB)	1.3
Device Voltage (V)	3
Current (mA)	25

1) OIP3 is measured with two tones at an output power of -5 dBm/tone separated by 1 MHz.

Schematic

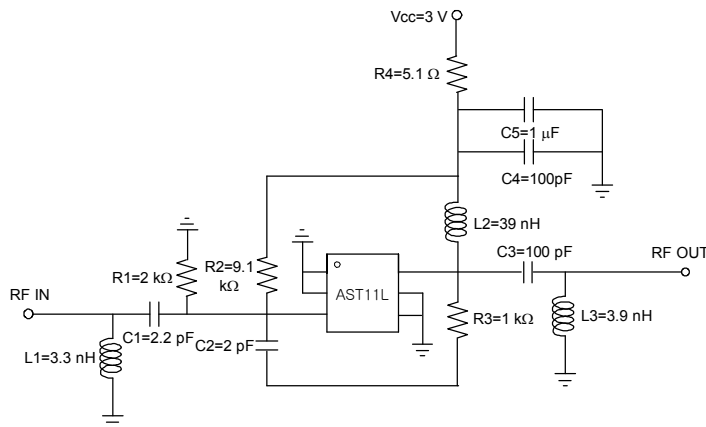

Board Layout (FR4, 40x40 mm², 0.8T)

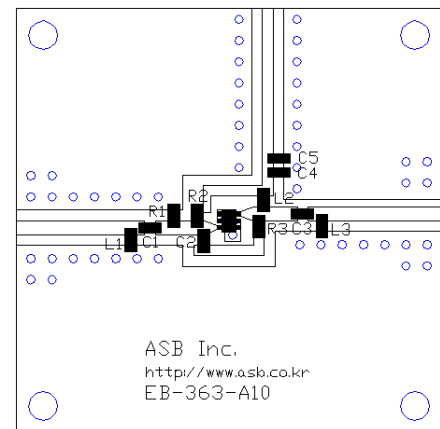

S-parameters & K-factor

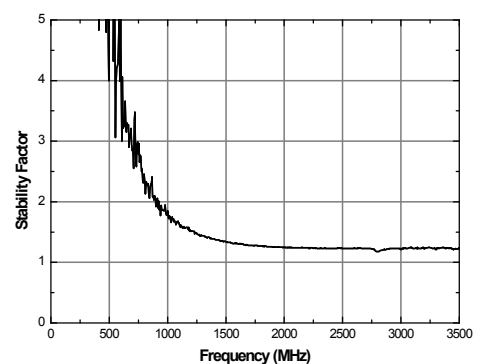
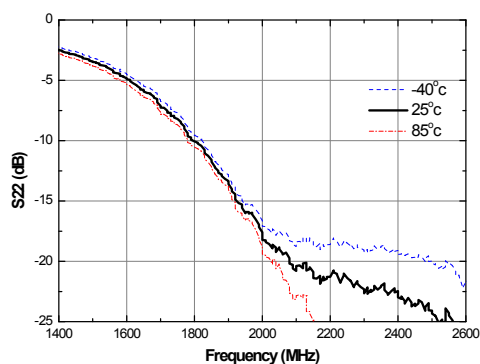
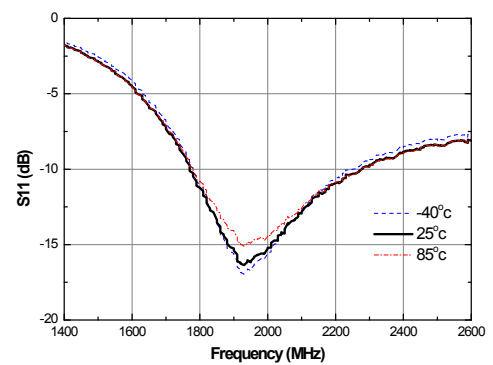
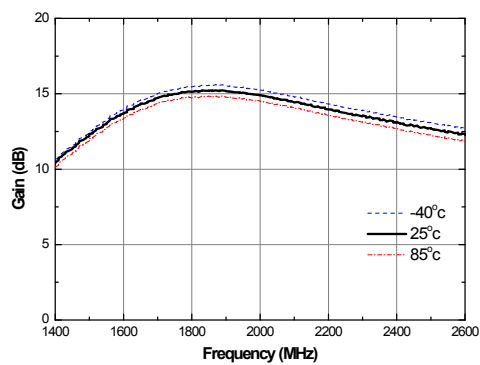

Current vs. Temperature

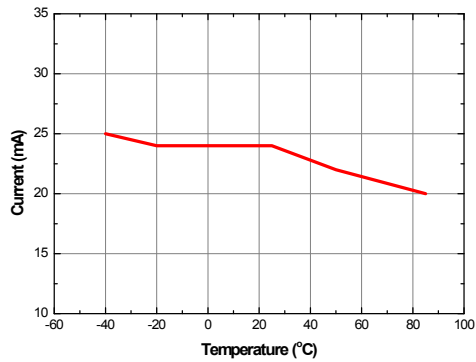

Gain vs. Temperature

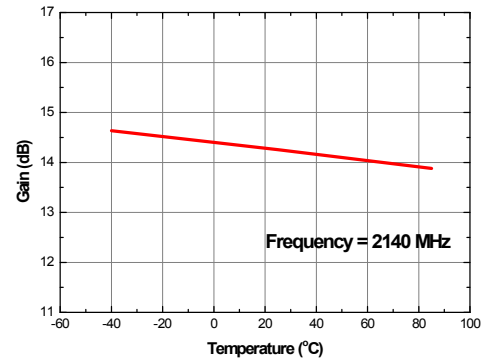

P1dB vs. Temperature

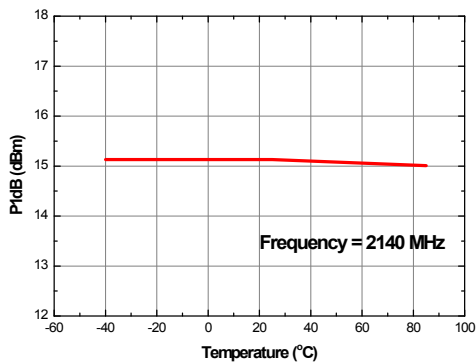

Output IP3 vs. Temperature

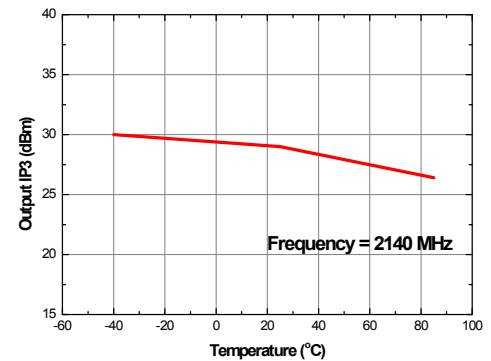

Output IP3 vs. Tone Power (Frequency = 2140 MHz)

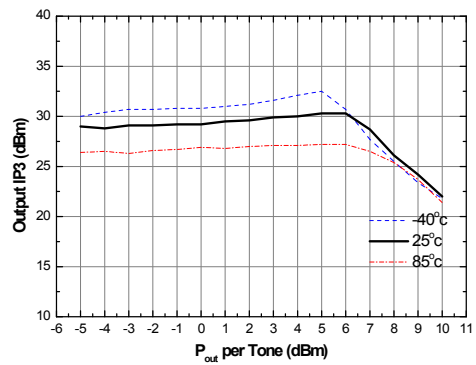

APPLICATION CIRCUIT

DVB-T(V Band)

170 ~ 240 MHz

+5 V

Frequency (MHz)	170	240
Magnitude S21 (dB)	14	14
Magnitude S11 (dB)	-9	-8
Magnitude S22 (dB)	-11	-11
Output P1dB (dBm)	5	5.5
Output IP3 ¹⁾ (dBm)	16	16.5
Noise Figure (dB)	1.8 (@380MHz)	
Device Voltage (V)	5	5
Current (mA)	13	13

1) OIP3 is measured with two tones at an output power of -5 dBm/tone separated by 1 MHz.

Schematic

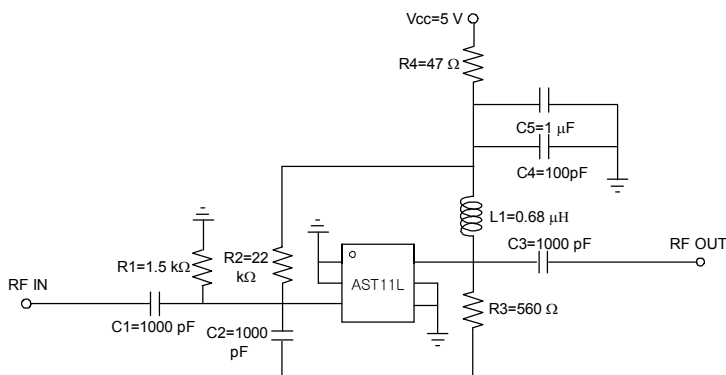

Board Layout (FR4, 40x40 mm², 0.8T)

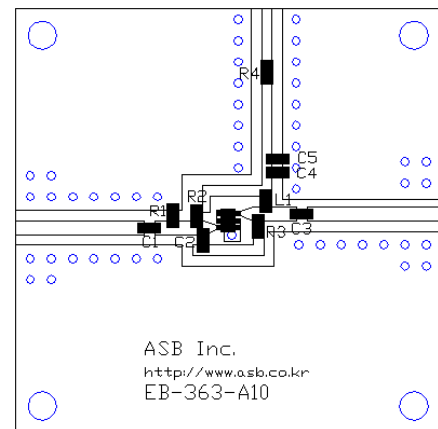

S-parameters & K-factor

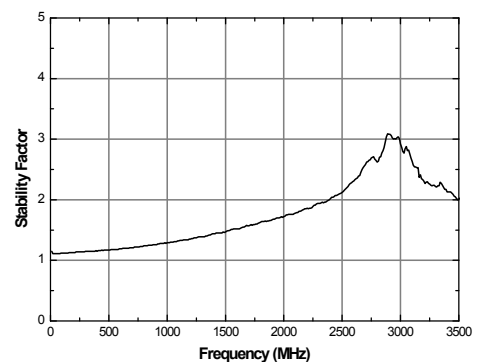
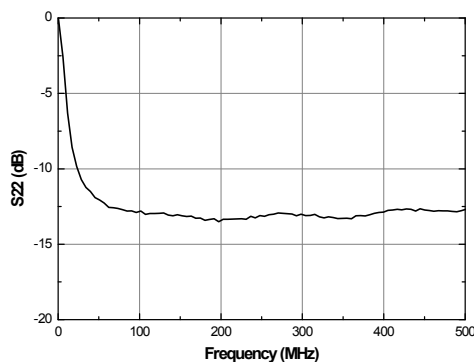
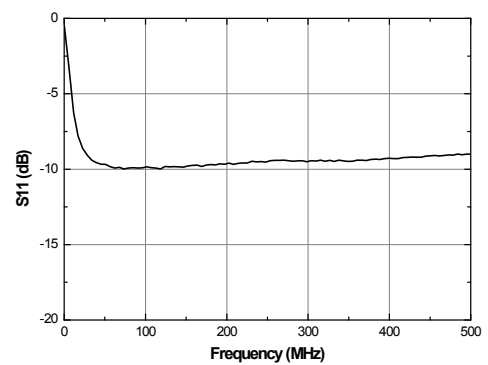
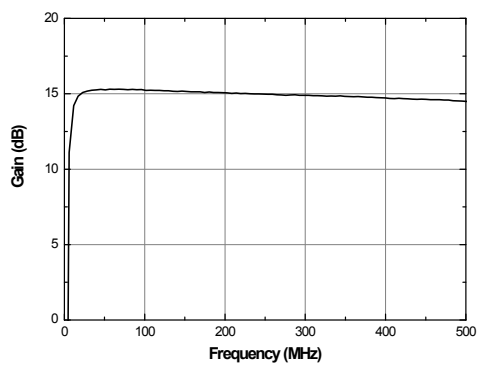

APPLICATION CIRCUIT

DVB-T(U Band)

478 ~ 862 MHz

+5 V

Frequency (MHz)	478	862
Magnitude S21 (dB)	16	15
Magnitude S11 (dB)	-9	-10
Magnitude S22 (dB)	-9	-9
Output P1dB (dBm)	6.5	6.5
Output IP3 ¹⁾ (dBm)	18	18.5
Noise Figure (dB)	1.8	1.6
Device Voltage (V)	5	5
Current (mA)	13	13

1) OIP3 is measured with two tones at an output power of -5 dBm/tone separated by 1 MHz.

Schematic

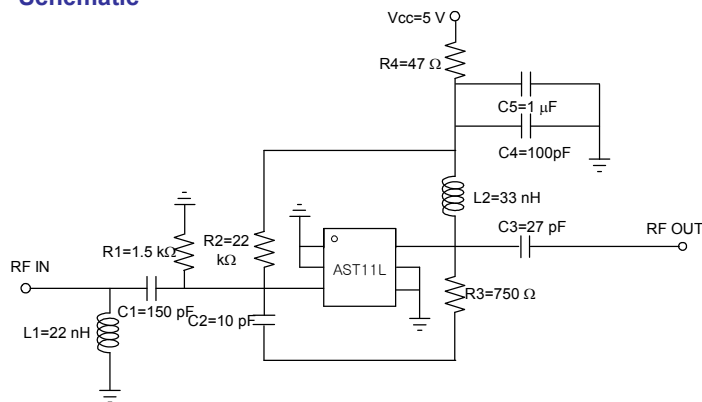

Board Layout (FR4, 40x40 mm², 0.8T)

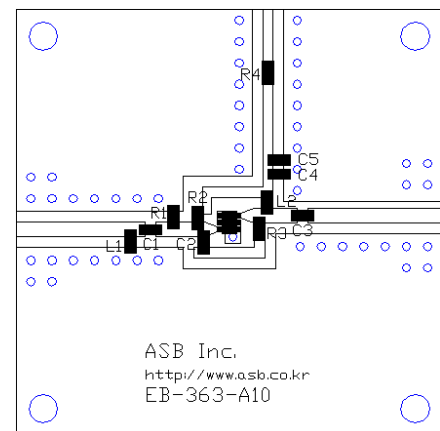

S-parameters & K-factor

