

TELUX LED

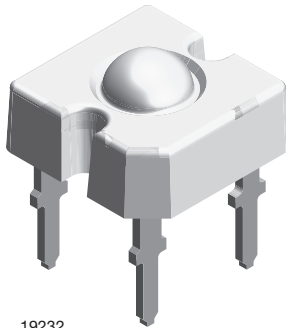

19232

DESCRIPTION

The TELUX series is a clear, non diffused LED for applications where supreme luminous flux is required.

It is designed in an industry standard 7.62 mm square package utilizing highly developed AlInGaP technology.

The supreme heat dissipation of TELUX allows applications at high ambient temperatures.

All packing units are binned for luminous flux, forward voltage and color to achieve the most homogenous light appearance in application.

SAE and ECE color requirements for automobile application are available for color red.

PRODUCT GROUP AND PACKAGE DATA

- Product group: LED
- Package: TELUX
- Product series: standard
- Angle of half intensity: $\pm 30^\circ$

FEATURES

- High luminous flux
- Supreme heat dissipation: R_{thJP} is 90 K/W
- High operating temperature:
 $T_{amb} = -40^\circ\text{C}$ to $+110^\circ\text{C}$
- Meets SAE and ECE color requirements for the automobile industry for color red
- Packed in tubes for automatic insertion
- Luminous flux, forward voltage and color categorized for each tube
- Small mechanical tolerances allow precise usage of external reflectors or lightguides
- Compatible with wave solder processes according to CECC 00802 and J-STD-020
- ESD-withstand voltage: up to 2 kV according to JESD22-A114-B
- AEC-Q101 qualified
- Material categorization: For definitions of compliance please see www.vishay.com/doc?99912

 AUTOMOTIVE
GRADE

RoHS
COMPLIANT
GREEN
(5-2009)

APPLICATIONS

- Exterior lighting
- Dashboard illumination
- Tail-, stop- and turn signals of motor vehicles
- Replaces small incandescent lamps
- Traffic signals and signs

PARTS TABLE

| PART | COLOR | LUMINOUS FLUX (mIm) | | | at I_F (mA) | WAVELENGTH (nm) | | | FORWARD VOLTAGE (V) | | | TECHNOLOGY |
|----------|--------|---------------------|------|------|---------------|-----------------|------|------|---------------------|------|------|-----------------|
| | | MIN. | TYP. | MAX. | | MIN. | TYP. | MAX. | MIN. | TYP. | MAX. | |
| TLWR7600 | Red | 1500 | 2100 | - | 70 | 611 | 618 | 634 | 1.83 | 2.2 | 2.67 | AlInGaP on GaAs |
| TLWY7600 | Yellow | 1000 | 1400 | - | 70 | 585 | 592 | 597 | 1.83 | 2.1 | 2.67 | AlInGaP on GaAs |

**ABSOLUTE MAXIMUM RATINGS** ($T_{amb} = 25\text{ }^{\circ}\text{C}$, unless otherwise specified)
TLWR7600, TLWY7600

| PARAMETER | TEST CONDITION | SYMBOL | VALUE | UNIT |
|-------------------------------------|--|------------|---------------|--------------------|
| Reverse voltage ⁽¹⁾ | $I_R = 100\ \mu\text{A}$ | V_R | 10 | V |
| DC forward current | $T_{amb} \leq 85\text{ }^{\circ}\text{C}$ | I_F | 70 | mA |
| Surge forward current | $t_p \leq 10\ \mu\text{s}$ | I_{FSM} | 1 | A |
| Power dissipation | | P_V | 187 | mW |
| Junction temperature | | T_j | 125 | $^{\circ}\text{C}$ |
| Operating temperature range | | T_{amb} | - 40 to + 110 | $^{\circ}\text{C}$ |
| Storage temperature range | | T_{stg} | - 55 to + 110 | $^{\circ}\text{C}$ |
| Soldering temperature | $t \leq 5\ \text{s}$, 1.5 mm from body preheat temperature $100\text{ }^{\circ}\text{C}/30\ \text{s}$ | T_{sd} | 260 | $^{\circ}\text{C}$ |
| Thermal resistance junction/ambient | With cathode heatsink of $70\ \text{mm}^2$ | R_{thJA} | 200 | K/W |
| Thermal resistance junction/pin | | R_{thJP} | 90 | K/W |

Note

(1) Driving the LED in reverse direction is suitable for a short term application

OPTICAL AND ELECTRICAL CHARACTERISTICS ($T_{amb} = 25\text{ }^{\circ}\text{C}$, unless otherwise specified)
TLWR7600, RED

| PARAMETER | TEST CONDITION | SYMBOL | MIN. | TYP. | MAX. | UNIT |
|--|--|--------------------|------|----------|------|---------|
| Total flux | $I_F = 70\ \text{mA}$, $R_{thJA} = 200\ \text{K/W}$ | ϕ_V | 1500 | 2100 | - | mlm |
| Luminous intensity/total flux | $I_F = 70\ \text{mA}$, $R_{thJA} = 200\ \text{K/W}$ | I_V/ϕ_V | - | 0.8 | - | mcd/mlm |
| Dominant wavelength | $I_F = 70\ \text{mA}$, $R_{thJA} = 200\ \text{K/W}$ | λ_d | 611 | 618 | 634 | nm |
| Peak wavelength | $I_F = 70\ \text{mA}$, $R_{thJA} = 200\ \text{K/W}$ | λ_p | - | 624 | - | nm |
| Angle of half intensity | $I_F = 70\ \text{mA}$, $R_{thJA} = 200\ \text{K/W}$ | φ | - | ± 30 | - | deg |
| Total included angle | 90 % of total flux captured | $\varphi_{0.9V}$ | - | 75 | - | deg |
| Forward voltage | $I_F = 70\ \text{mA}$, $R_{thJA} = 200\ \text{K/W}$ | V_F | 1.83 | 2.2 | 2.67 | V |
| Reverse voltage | $I_R = 10\ \mu\text{A}$ | V_R | 10 | 20 | - | V |
| Junction capacitance | $V_R = 0\ \text{V}$, $f = 1\ \text{MHz}$ | C_j | - | 17 | - | pF |
| Temperature coefficient of λ_{dom} | $I_F = 50\ \text{mA}$ | $T_C\lambda_{dom}$ | - | 0.05 | - | nm/K |

OPTICAL AND ELECTRICAL CHARACTERISTICS ($T_{amb} = 25\text{ }^{\circ}\text{C}$, unless otherwise specified)
TLWY7600, YELLOW

| PARAMETER | TEST CONDITION | SYMBOL | MIN. | TYP. | MAX. | UNIT |
|--|--|--------------------|------|----------|------|---------|
| Total flux | $I_F = 70\ \text{mA}$, $R_{thJA} = 200\ \text{K/W}$ | ϕ_V | 1000 | 1400 | - | mlm |
| Luminous intensity/total flux | $I_F = 70\ \text{mA}$, $R_{thJA} = 200\ \text{K/W}$ | I_V/ϕ_V | - | 0.8 | - | mcd/mlm |
| Dominant wavelength | $I_F = 70\ \text{mA}$, $R_{thJA} = 200\ \text{K/W}$ | λ_d | 585 | 592 | 597 | nm |
| Peak wavelength | $I_F = 70\ \text{mA}$, $R_{thJA} = 200\ \text{K/W}$ | λ_p | - | 594 | - | nm |
| Angle of half intensity | $I_F = 70\ \text{mA}$, $R_{thJA} = 200\ \text{K/W}$ | φ | - | ± 30 | - | deg |
| Total included angle | 90 % of total flux captured | $\varphi_{0.9V}$ | - | 75 | - | deg |
| Forward voltage | $I_F = 70\ \text{mA}$, $R_{thJA} = 200\ \text{K/W}$ | V_F | 1.83 | 2.1 | 2.67 | V |
| Reverse voltage | $I_R = 10\ \mu\text{A}$ | V_R | 10 | 15 | - | V |
| Junction capacitance | $V_R = 0\ \text{V}$, $f = 1\ \text{MHz}$ | C_j | - | 32 | - | pF |
| Temperature coefficient of λ_{dom} | $I_F = 50\ \text{mA}$ | $T_C\lambda_{dom}$ | - | 0.1 | - | nm/K |



| LUMINOUS FLUX CLASSIFICATION | | |
|------------------------------|---------------------|------|
| GROUP | LUMINOUS FLUX (mIm) | |
| | STANDARD | MIN. |
| B | 1000 | 1800 |
| C | 1500 | 2400 |
| D | 2000 | 3000 |
| E | 2500 | 3600 |
| F | 3000 | 4200 |
| G | 3500 | 4800 |
| H | 4000 | 6100 |
| I | 5000 | 7300 |
| K | 6000 | 9700 |

Note

- Luminous flux is tested at a current pulse duration of 25 ms and an accuracy of ± 11 %.
- The above type numbers represent the order groups which include only a few brightness groups. Only one group will be shipped on each tube (there will be no mixing of two groups on each tube).
- In order to ensure availability, single brightness groups will not be orderable.
- In a similar manner for colors where wavelength groups are measured and binned, single wavelength groups will be shipped in any one tube.
- In order to ensure availability, single wavelength groups will not be orderable.

| COLOR CLASSIFICATION | | | | |
|----------------------|----------------------|------|------|------|
| GROUP | DOM. WAVELENGTH (nm) | | | |
| | YELLOW | | RED | |
| | MIN. | MAX. | MIN. | MAX. |
| 0 | 585 | 588 | | |
| 1 | 587 | 591 | 611 | 618 |
| 2 | 589 | 594 | 614 | 622 |
| 3 | 592 | 597 | 616 | 634 |

Note

- Wavelengths are tested at a current pulse duration of 25 ms and an accuracy of ± 1 nm.

| FORWARD VOLTAGE CLASSIFICATION | | |
|--------------------------------|---------------------|------|
| GROUP | FORWARD VOLTAGE (V) | |
| | MIN. | MAX. |
| Y | 1.83 | 2.07 |
| Z | 1.95 | 2.19 |
| 0 | 2.07 | 2.31 |
| 1 | 2.19 | 2.43 |
| 2 | 2.31 | 2.55 |
| 3 | 2.43 | 2.67 |

Note

- Voltages are tested at a current pulse duration of 1 ms.

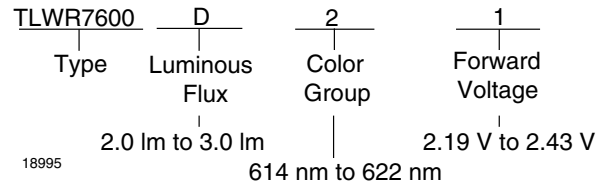

TYPICAL CHARACTERISTICS ($T_{amb} = 25\text{ }^{\circ}\text{C}$, unless otherwise specified)

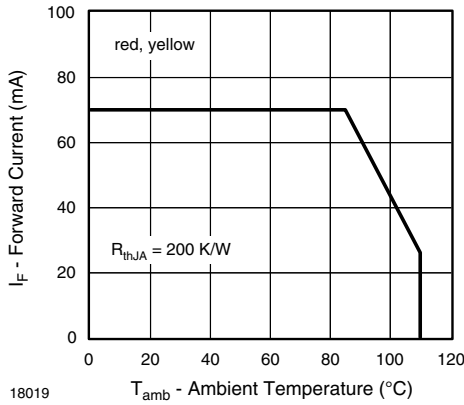

Fig. 1 - Forward Current vs. Ambient Temperature

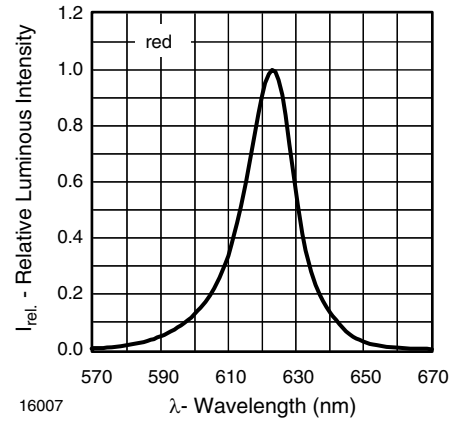

Fig. 4 - Relative Intensity vs. Wavelength

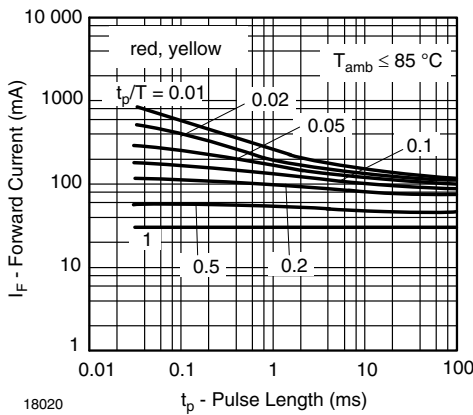

Fig. 2 - Forward Current vs. Pulse Length

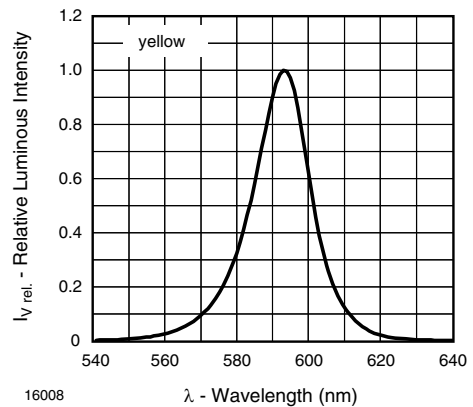

Fig. 5 - Relative Intensity vs. Wavelength

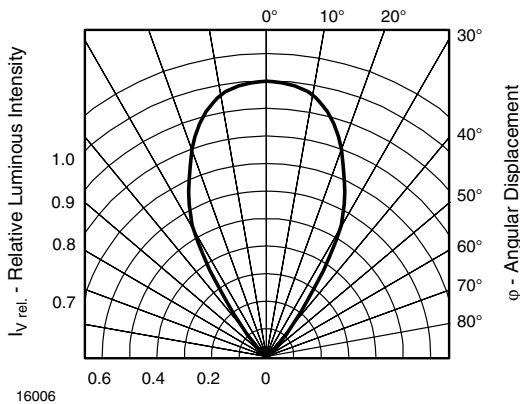

Fig. 3 - Relative Luminous Intensity vs. Angular Displacement

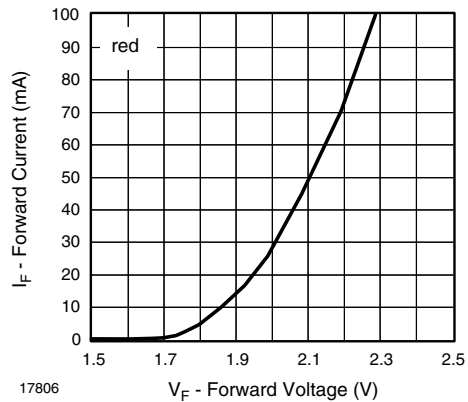
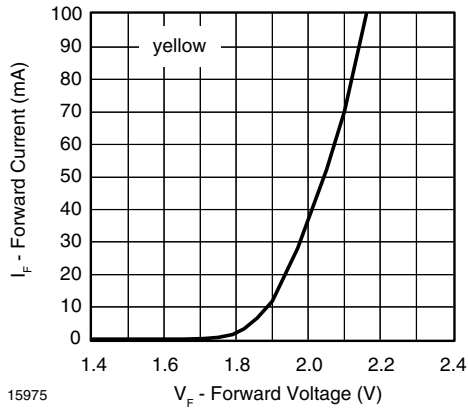
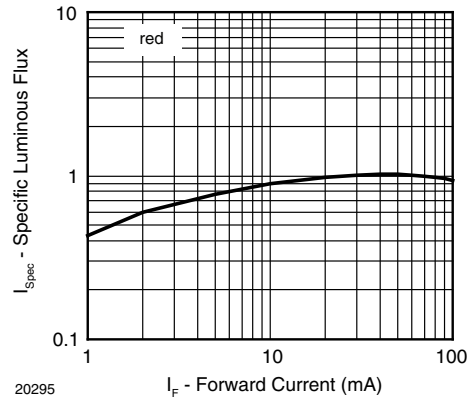

Fig. 6 - Forward Current vs. Forward Voltage



15975

Fig. 7 - Forward Current vs. Forward Voltage



20295

Fig. 10 - Specific Luminous Flux vs. Forward Current

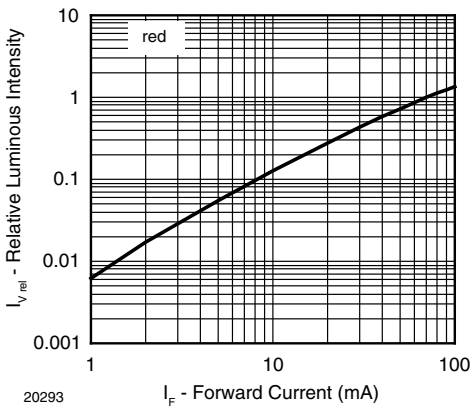

20293

Fig. 8 - Relative Luminous Intensity vs. Forward Current

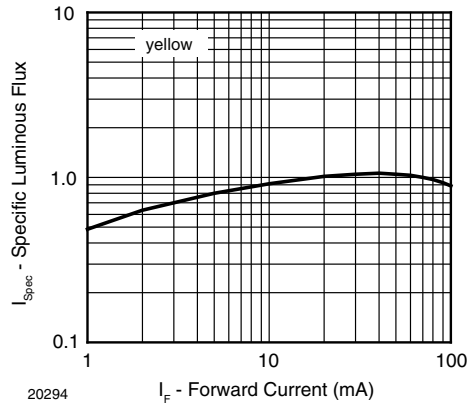

20294

Fig. 11 - Specific Luminous Flux vs. Forward Current

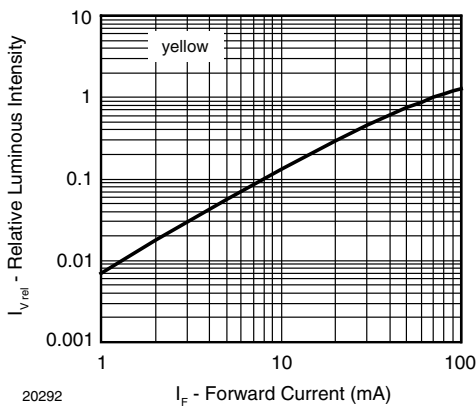

20292

Fig. 9 - Relative Luminous Intensity vs. Forward Current

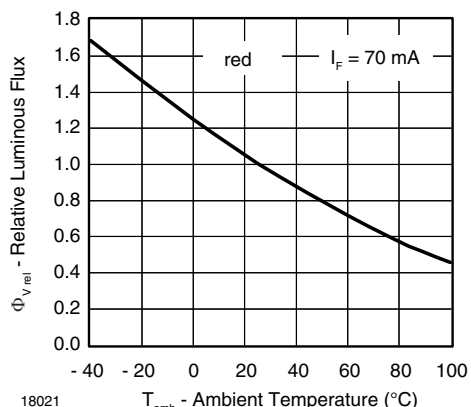

18021

Fig. 12 - Relative Luminous Flux vs. Ambient Temperature

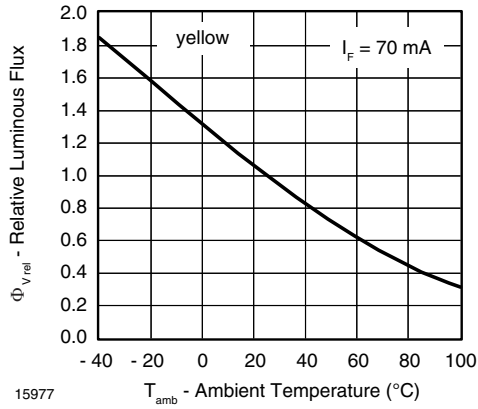

Fig. 13 - Relative Luminous Flux vs. Ambient Temperature

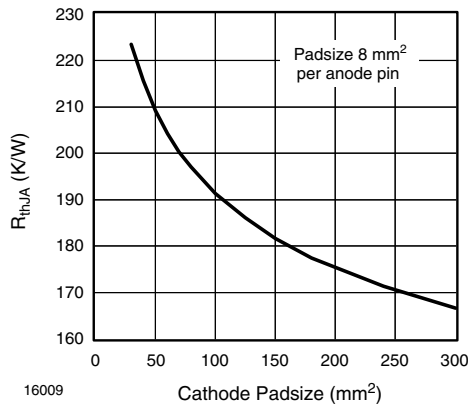

Fig. 14 - Thermal Resistance Junction Ambient vs. Cathode Padsize

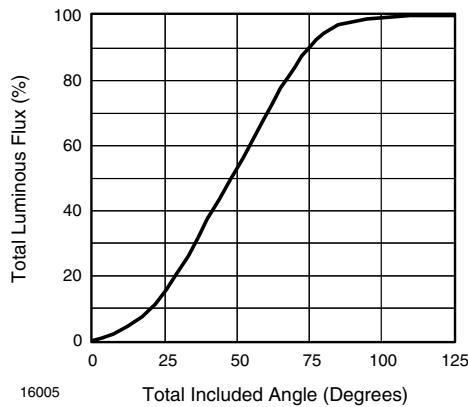
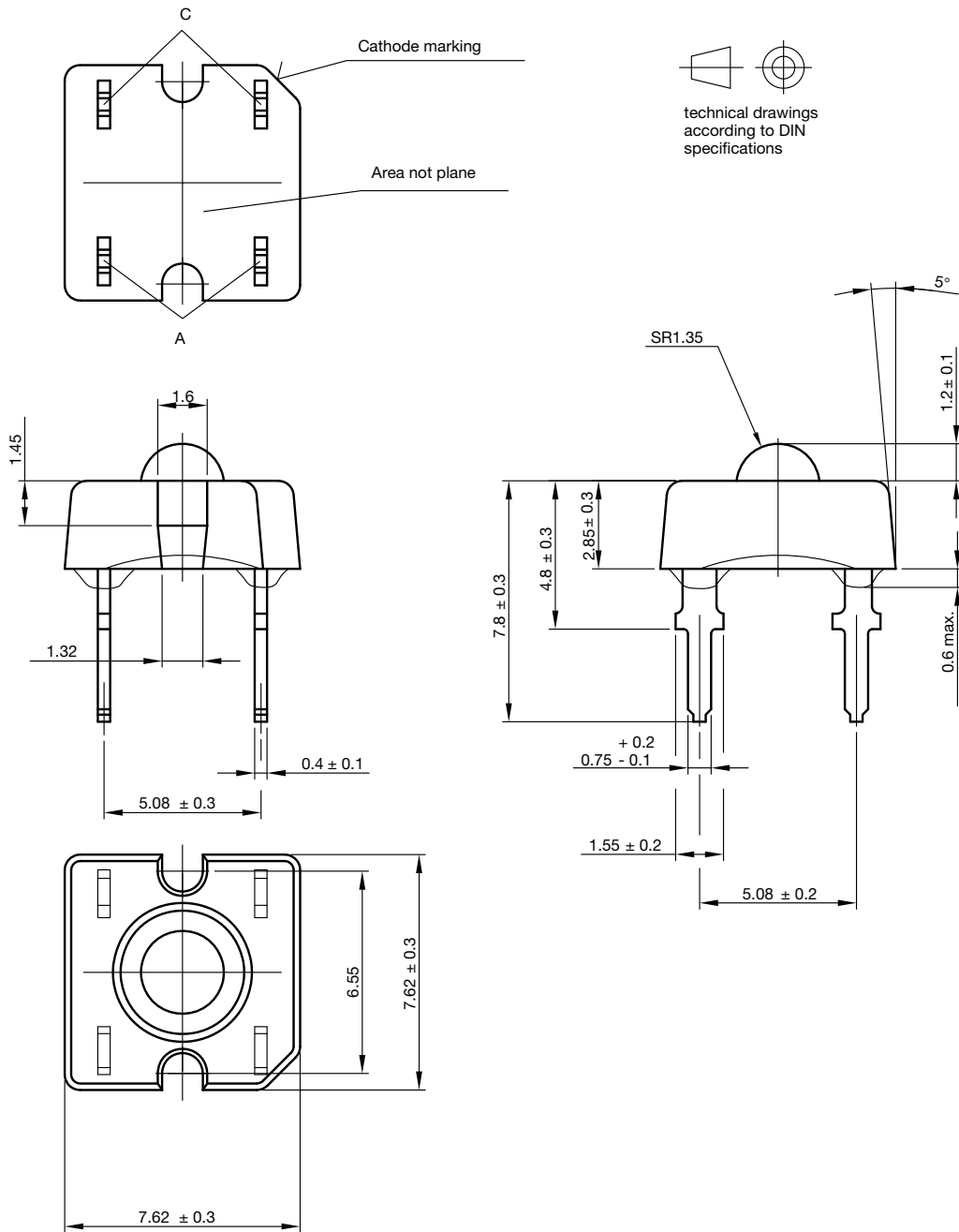

Fig. 15 - Percentage Total Luminous Flux vs. Total Included Angle for 90° Emission Angle



PACKAGE DIMENSIONS in millimeters



Drawing-No.: 6.544-5321.02-4
 Issue: 3; 26.06.06
 16004



FAN FOLD BOX DIMENSIONS in millimeters

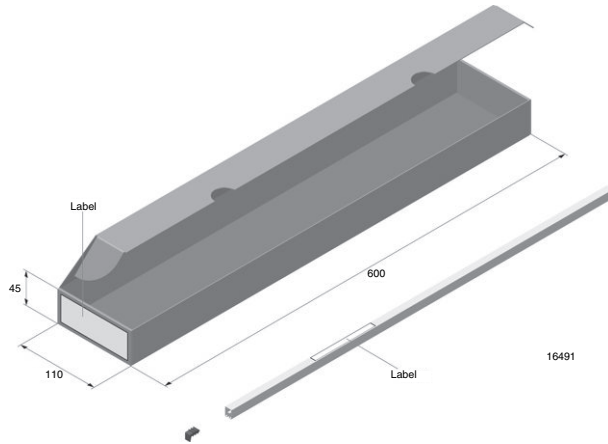

LABEL OF FAN FOLD BOX (example)

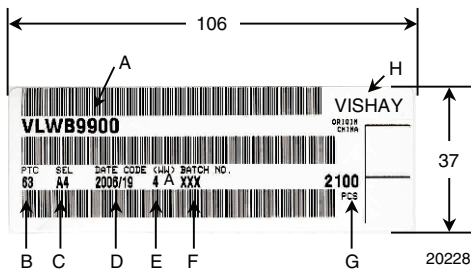

- A. Type of component
- B. Manufacturing plant
- C. SEL - selection code (bin):
e.g.: A = code for luminous intensity group
4 = code for color group
- D. Date code year/week
- E. Day code (e.g. 4: Thursday, A: early shift)
- F. Batch: no.
- G. Total quantity
- H. Company code

EXAMPLE FOR TELUX TUBE LABEL DIMENSIONS in millimeters

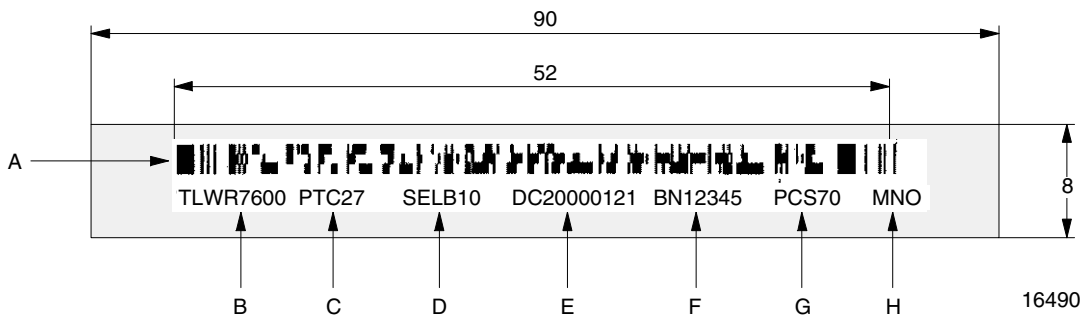

- A. Bar code
- B. Type of component
- C. Manufacturing plant
- D. SEL - selection code (bin):
digit 1 - code for luminous flux group
digit 2 - code for dominant wavelength group
digit 3 - code for forward voltage group
- E. Date code
- F. Batch: no.
- G. Total quantity
- H. Company code

TUBE WITH BAR CODE LABEL DIMENSIONS in millimeters

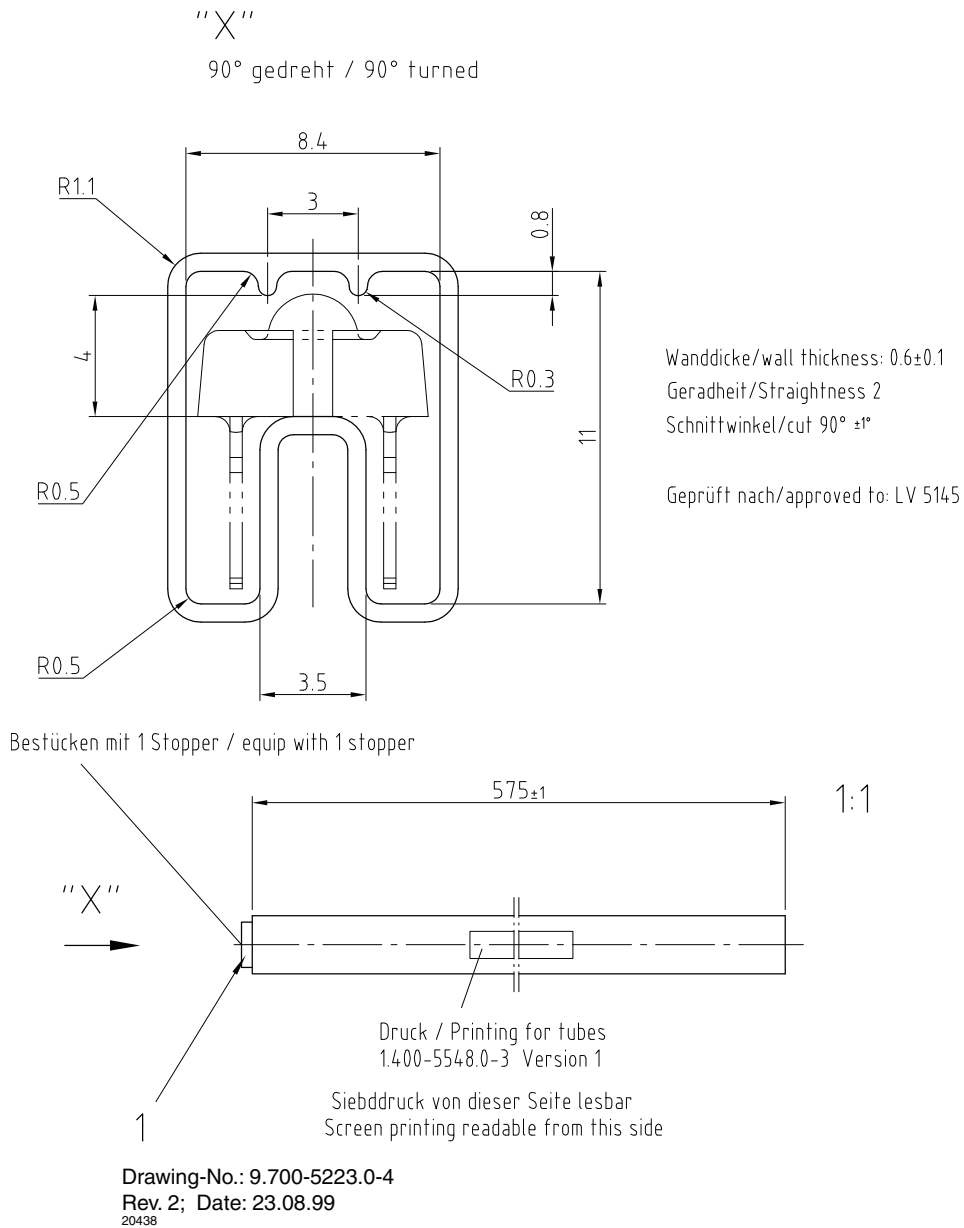

Fig. 16 - Drawing Proportions not Scaled



Disclaimer

ALL PRODUCT, PRODUCT SPECIFICATIONS AND DATA ARE SUBJECT TO CHANGE WITHOUT NOTICE TO IMPROVE RELIABILITY, FUNCTION OR DESIGN OR OTHERWISE.

Vishay Intertechnology, Inc., its affiliates, agents, and employees, and all persons acting on its or their behalf (collectively, "Vishay"), disclaim any and all liability for any errors, inaccuracies or incompleteness contained in any datasheet or in any other disclosure relating to any product.

Vishay makes no warranty, representation or guarantee regarding the suitability of the products for any particular purpose or the continuing production of any product. To the maximum extent permitted by applicable law, Vishay disclaims (i) any and all liability arising out of the application or use of any product, (ii) any and all liability, including without limitation special, consequential or incidental damages, and (iii) any and all implied warranties, including warranties of fitness for particular purpose, non-infringement and merchantability.

Statements regarding the suitability of products for certain types of applications are based on Vishay's knowledge of typical requirements that are often placed on Vishay products in generic applications. Such statements are not binding statements about the suitability of products for a particular application. It is the customer's responsibility to validate that a particular product with the properties described in the product specification is suitable for use in a particular application. Parameters provided in datasheets and/or specifications may vary in different applications and performance may vary over time. All operating parameters, including typical parameters, must be validated for each customer application by the customer's technical experts. Product specifications do not expand or otherwise modify Vishay's terms and conditions of purchase, including but not limited to the warranty expressed therein.

Except as expressly indicated in writing, Vishay products are not designed for use in medical, life-saving, or life-sustaining applications or for any other application in which the failure of the Vishay product could result in personal injury or death. Customers using or selling Vishay products not expressly indicated for use in such applications do so at their own risk and agree to fully indemnify and hold Vishay and its distributors harmless from and against any and all claims, liabilities, expenses and damages arising or resulting in connection with such use or sale, including attorneys fees, even if such claim alleges that Vishay or its distributor was negligent regarding the design or manufacture of the part. Please contact authorized Vishay personnel to obtain written terms and conditions regarding products designed for such applications.

No license, express or implied, by estoppel or otherwise, to any intellectual property rights is granted by this document or by any conduct of Vishay. Product names and markings noted herein may be trademarks of their respective owners.

Material Category Policy

Vishay Intertechnology, Inc. hereby certifies that all its products that are identified as RoHS-Compliant fulfill the definitions and restrictions defined under Directive 2011/65/EU of The European Parliament and of the Council of June 8, 2011 on the restriction of the use of certain hazardous substances in electrical and electronic equipment (EEE) - recast, unless otherwise specified as non-compliant.

Please note that some Vishay documentation may still make reference to RoHS Directive 2002/95/EC. We confirm that all the products identified as being compliant to Directive 2002/95/EC conform to Directive 2011/65/EU.