



AVR601: Atmel Modular Evaluation Kits for Motor Control Applications

8-bit AVR[®]
Microcontrollers

Application Note

1. Introduction

Following the success of the MC100 and MC200 motor control demonstration kits, Atmel is expanding the support for motor control applications and presents a new modular concept for Motor Control evaluation kits. As shown on figure 1, each motor application is now supported by two or three evaluation boards:

- A power board providing the high current to the motor
- A processor board supporting one AVR microcontroller and the user interface
- An optional interface board which may be physically inserted between the Power Board and the Processor Board for signal conditioning.

Figure 1-1. System Architecture

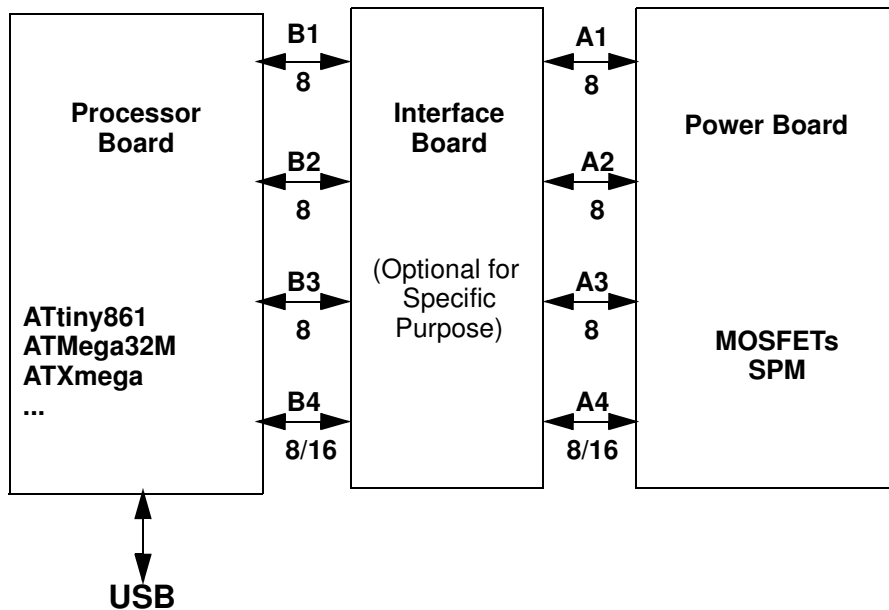

The offering includes one low voltage power board, three processor boards and the associated firmware. These four boards as shown on figure 2:

- MC300 is the low voltage power board (max 40V).
- MC301 is the processor board with the low cost ATtinyx61
- MC303 is the processor board with the new high performance XMEGA™
- MC310 is the processor board with the ATmega32M1 (with CAN interface)
- More processor boards will become available in the future

Figure 1-2. Motor control Boards offering

MC303



MC301

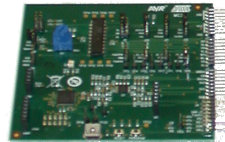

MC310

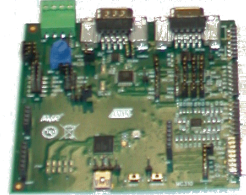

MC300

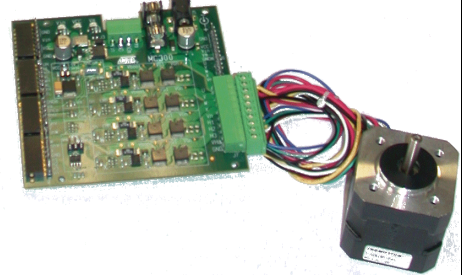

The Atmel Motor Control Interface bus (AMCI bus) shown on [Figure 1-3](#), allows the communication between the power board and the processor board; most motor types are supported by this interface:

- BLDC and BLAC motors
- AC induction motors
- Switch reluctance motors
- Stepper motors

The AMCI bus uses three 8 bit connectors and one 8/16 bit connector.

The interface supports up to four phases (U, V, W, X), each with half bridge control and both voltage and current feedback. With three phase motors, the free X channel can be used for a brake function.

The interface also supports Hall sensors, speed, temperature and fault signals and also allows the control of the PFC (Power Factor Correction) from the CPU board. All signals are logic signals or analog signals scaled to reach the digital Vcc.

Figure 1-3. AMCI Motor Control bus

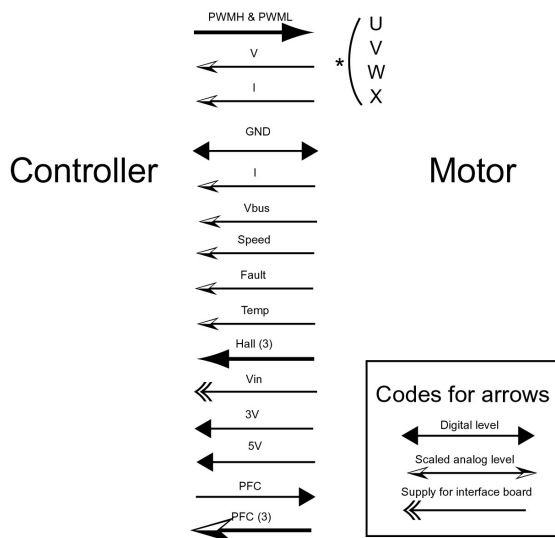

This bus can be used by any AVR microcontroller to control a motor. This is an ideal interface to optimize the system cost and to identify the cheapest solution with the required level of performance.

2. Processor boards

As shown on [Figure 5](#), each processor board has similar architecture and features; it includes:

- The corresponding AVR processor, which handles the motor control application and the other tasks.
- A USB interface for communication with the host using Atmel Motor Control PC software. The USB bridge is handled by an AT90USB1287.
- A connector to plug in an optional ATAVRDB101 display and Human Machine Interface board.
- A potentiometer for providing analog speed target to the controller.
- Programming and debugging connectors.
- The four AMCI Motor Control bus connectors.

Figure 2-2. MC303 with DB101 display and HMI top module

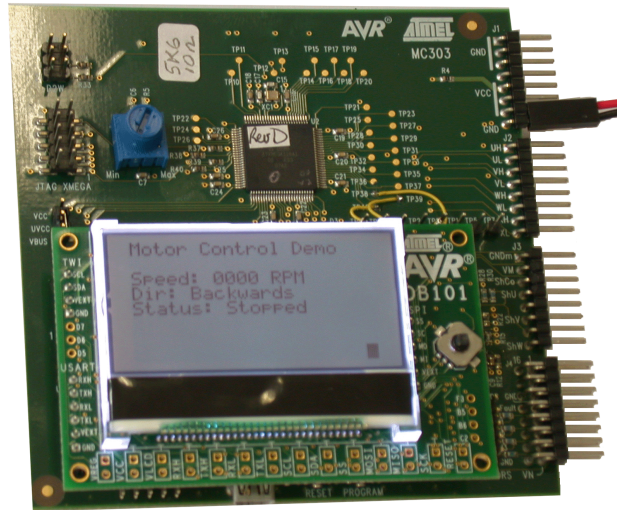

3. MC300 low voltage power interface

This board, shown on figure 7, is intended to drive low voltage, medium power motors with following specifications:

- Voltage from 10 to 40 VDC.
- Current up to 6 Amperes (continuous load)

The power board supplies the processor board.

The board provides interface for Hall sensors or back EMF information to run sensorless control of the motor.

The MC300, mainly targeted to drive BLDC and BLAC motors, can also be used with other motors types like stepper motors.

Figure 3-1. MC300 board with BLDC motor

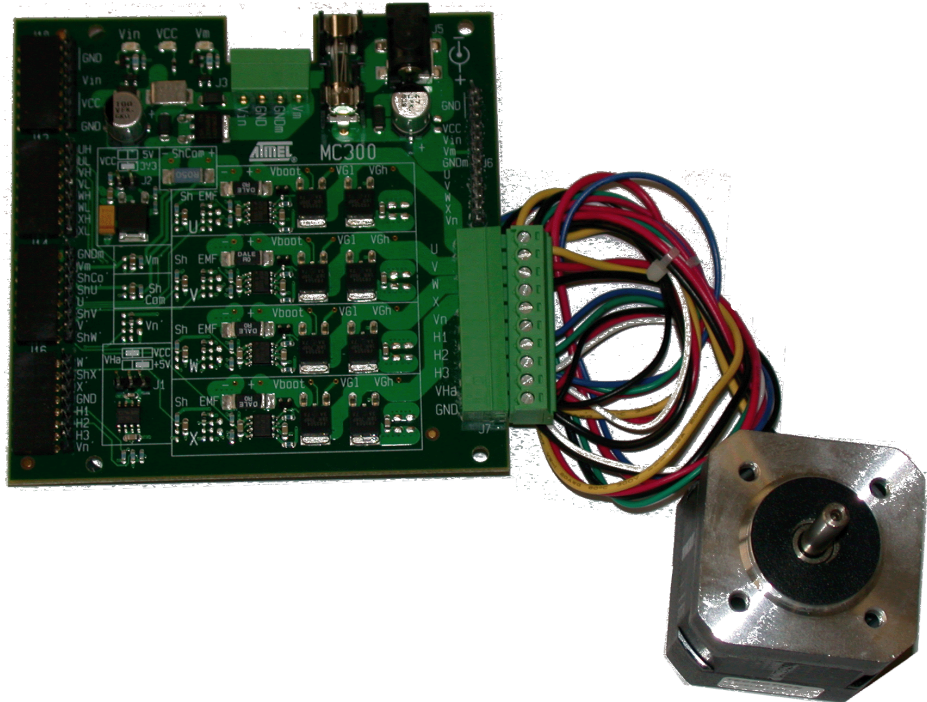

4. Firmware package

The flexibility of the modular hardware approach is supported by a growing software package. BLDC and BLAC motors with sensor control are fully supported. Sensorless control is also supported.

Please refer to Atmel web site www.atmel.com/motorcontrol for availability of application notes and code examples.

Even if a specific combination of microcontroller, driver stage and motor type might not be available from at the release, the similarity in fundamental functionality motors means that it is an option to extract relevant parts of the existing code examples, and modify and reuse it in other implementations.

5. Availability & Ordering codes

To simplify the order entry, complete evaluation kits are also available:

MC320 includes the MC310 processor board, the MC300 power board and a small BLDC motor (see figure 8)

MC321 includes the MC301 processor board , the MC300 power board and a small BLDC motor

MC323 includes the MC303 processor board , the MC300 power board and a small BLDC motor

Figure 5-1. MC320 Evaluation kit



MC300, 301, 303, 310, 320, 321 and 323 have the following ordering codes:

- ATAVRMC300
- ATAVRMC301
- ATAVRMC303
- ATAVRMC310
- ATAVRMC320 (includes MC300, MC310, 12V BLDC motor and USB cable)
- ATAVRMC321 (includes MC300, MC301, 12V BLDC motor and USB cable)
- ATAVRMC323 (includes MC300, MC303, 12V BLDC motor and USB cable)

The ATAVRDB101 display and Human Machine Interface add on board is also available.

Documentation available:

AVR430 - MC300 Hardware User's Guide

AVR469 – MC301 Hardware User's Guide

AVR470 – MC310 Hardware User's Guide

AVR194 Brushless DC Motor Control using Atmega32M1

Other documentation available:

- AVR435: BLDC/BLAC Motor Control Using a Sinus Modulated PWM Algorithm
- AVR440: Sensorless Control of Two-Phase Brushless DC Motor
- AVR441: Intelligent BLDC Fan Controller with Temperature Sensor and Serial Interface
- AVR442: BLDC Fan Motor Control with ATtiny13
- AVR443: Sensor-based control of three phase Brushless DC motor
- AVR444: Sensorless control of 3-phase brushless DC motors
- AVR446: Linear speed control of stepper motor
- AVR447: Sinusoidal driving of three-phase permanent magnet motor using ATmega48/88/168
- AVR448: Control of High Voltage Three-phase BLDC Motor
- AVR449: Sinusoidal driving of 3-phase permanent magnet motor using ATtiny261/461/861
- AVR452: Sensor-based Control of Three Phase Brushless DC Motors Using AT90CAN128/64/32
- AVR492: Brushless DC Motor control using AT90PWM3
- AVR493: Sensorless Commutation of Brushless DC Motor (BLDC) using AT90PWM3 and ATAVRMC100
- AVR494: AC Induction Motor Control Using the constant V/f Principle and a Natural PWM Algorithm
- AVR495: AC Induction Motor Control Using the Constant V/f Principle and a Space-vector PWM Algorithm
- Refer to www.atmel.com for the complete and updated list.



Headquarters

Atmel Corporation
2325 Orchard Parkway
San Jose, CA 95131
USA
Tel: 1(408) 441-0311
Fax: 1(408) 487-2600

International

Atmel Asia
Room 1219
Chinachem Golden Plaza
77 Mody Road Tsimshatsui
East Kowloon
Hong Kong
Tel: (852) 2721-9778
Fax: (852) 2722-1369

Atmel Europe
Le Krebs
8, Rue Jean-Pierre Timbaud
BP 309
78054 Saint-Quentin-en-
Yvelines Cedex
France
Tel: (33) 1-30-60-70-00
Fax: (33) 1-30-60-71-11

Atmel Japan
9F, Tonetsu Shinkawa Bldg.
1-24-8 Shinkawa
Chuo-ku, Tokyo 104-0033
Japan
Tel: (81) 3-3523-3551
Fax: (81) 3-3523-7581

Product Contact

Web Site
www.atmel.com

Technical Support
avr@atmel.com

Sales Contact
www.atmel.com/contacts

Literature Requests
www.atmel.com/literature

Disclaimer: The information in this document is provided in connection with Atmel products. No license, express or implied, by estoppel or otherwise, to any intellectual property right is granted by this document or in connection with the sale of Atmel products. **EXCEPT AS SET FORTH IN ATMEL'S TERMS AND CONDITIONS OF SALE LOCATED ON ATMEL'S WEB SITE, ATMEL ASSUMES NO LIABILITY WHATSOEVER AND DISCLAIMS ANY EXPRESS, IMPLIED OR STATUTORY WARRANTY RELATING TO ITS PRODUCTS INCLUDING, BUT NOT LIMITED TO, THE IMPLIED WARRANTY OF MERCHANTABILITY, FITNESS FOR A PARTICULAR PURPOSE, OR NON-INFRINGEMENT. IN NO EVENT SHALL ATMEL BE LIABLE FOR ANY DIRECT, INDIRECT, CONSEQUENTIAL, PUNITIVE, SPECIAL OR INCIDENTAL DAMAGES (INCLUDING, WITHOUT LIMITATION, DAMAGES FOR LOSS OF PROFITS, BUSINESS INTERRUPTION, OR LOSS OF INFORMATION) ARISING OUT OF THE USE OR INABILITY TO USE THIS DOCUMENT, EVEN IF ATMEL HAS BEEN ADVISED OF THE POSSIBILITY OF SUCH DAMAGES.** Atmel makes no representations or warranties with respect to the accuracy or completeness of the contents of this document and reserves the right to make changes to specifications and product descriptions at any time without notice. Atmel does not make any commitment to update the information contained herein. Unless specifically provided otherwise, Atmel products are not suitable for, and shall not be used in, automotive applications. Atmel's products are not intended, authorized, or warranted for use as components in applications intended to support or sustain life.

© 2008 Atmel Corporation. All rights reserved. Atmel®, Atmel logo and combinations thereof, AVR® and others are registered trademarks XMEGA™ and others are trademarks of Atmel Corporation or its subsidiaries. Other terms and product names may be trademarks of others.