

LED Strip Specifications

PRODUCT SPECIFICATION

Model No.: FYLH-5050UX3C-30-12V-LW

Applications:
<ul style="list-style-type: none"> ■ Channel Letters ■ Lighting source for shop windows ■ Indoor Decoration Lighting ■ Advertising Signs ■ Replacement for Neon



CUSTOMER APPROVED SIGNATURES	APPROVED BY	CHECKED BY	PREPARED BY

NINGBO FORYARD OPTOELECTRONICS CO.,LTD.

Add:NO.115 Qixin Road Ningbo Zhejiang China

Zip:315051

Tel: 0086-574-87933652 87927870 87922206

Fax: 0086-574-87927917

E-mail:Sales@foryard.com (General)

[Http://www.foryard.com](http://www.foryard.com)

Model No.: FYLH-5050UX3C-30-12V-LW

Photo

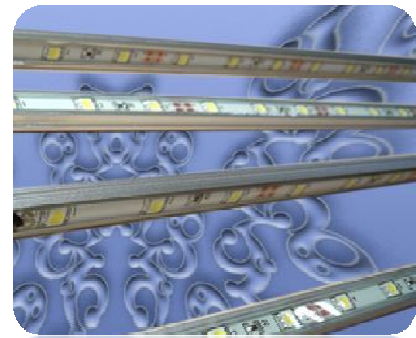

Drawing (1 PC)

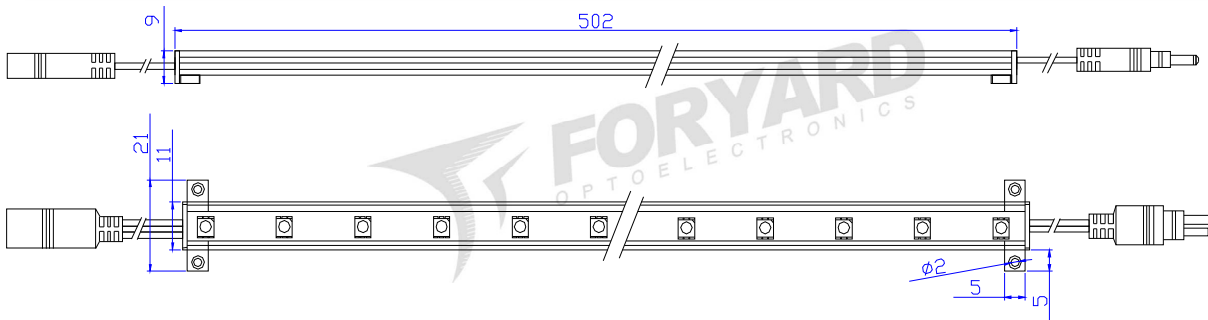

Notes:

1. All dimensions are millimeters.
2. Tolerance is $\pm 0.2\text{mm}$ unless otherwise specified.
3. Specifications are subject to change without notice.
4. Dimension: L502*W11*H9mm.without prior notice.

Circuit Diagram(1PC)

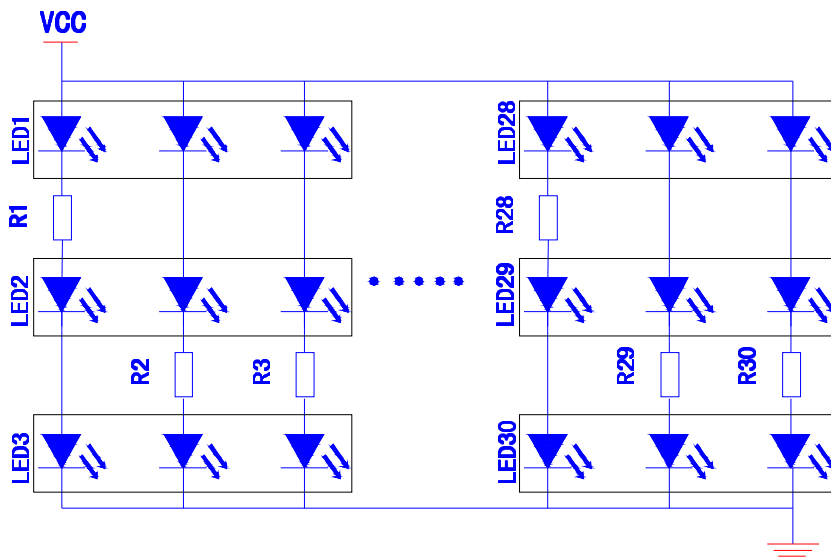

Model No.: FYLH-5050UX3C-30-12V-LW

■ Rating Electrical/Optical Characteristics(1PC)

Item	Red	Yellow	Blue	Green	White
Operation Voltage(V)	DC12	DC12	DC12	DC12	DC12
Power Dissipation(W)	7.2	7.2	7.2	7.2	7.2
Input Current(mA)	600	600	600	600	600
Wavelength(nm)	625-635	590-594	465-475	515-525	CCT:5000K-6500K
Single LED Luminous Intensity(MCD)	4500	4800	3000	3200	6000
Luminous Flux(lm)	480	500	280	360	540
Angle(°)	120				
Operation Temperature(°C)	-20~60				
single LED Operating	20				
LED Quantity(pcs)	60				
Dimension:(mm)	L502*W11*H9mm				
Life Time(hrs)	50000				
net weight:(g)	120				
Approval	CE(NO:E8N 08 03 57489 001)				

Model No.: FYLH-5050UX3C-30-12V-LW

Package

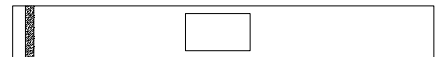
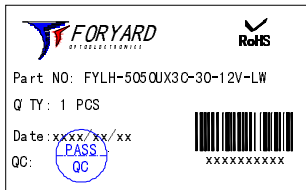

1Pcs / Polybag

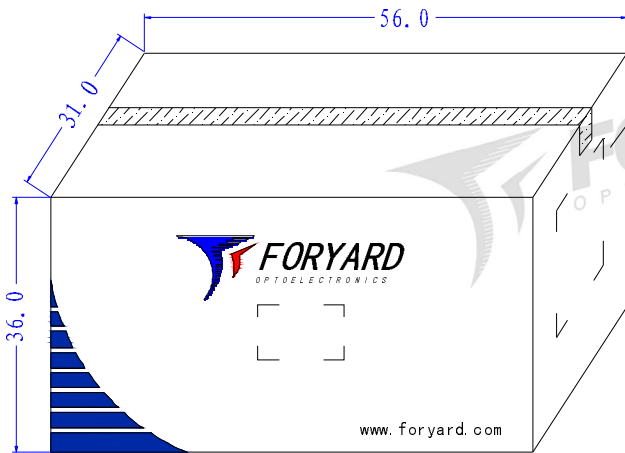

4Boxes/Carton

OUTSIDE LABEL

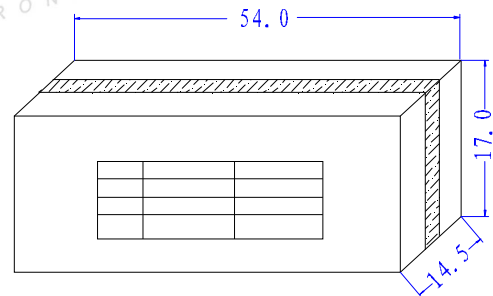

50 Bags/Box



OUTSIDE LABEL