

Linear Systems replaces discontinued Siliconix J175

The LSJ175 is a single P-Channel JFET switch

This p-channel analog switch is designed to provide low on-resistance and fast switching. When used in combination with the complimentary J/SST111 n-channel family, the LSJ175 simplifies series-shunt switching applications

LSJ175 Benefits:

- Low Error Voltage
- High-Speed Analog Circuit Performance
- Negligible "Off-Error," Excellent Accuracy
- Good Frequency Response
- Eliminates Additional Buffering

LSJ175 Applications:

- Analog Switches
- Choppers
- Sample-and-Hold
- Normally "On" Switches
- Current Limiters

FEATURES

DIRECT REPLACEMENT FOR SILICONIX J175

LOW ON RESISTANCE	$r_{DS(on)} \leq 125\Omega$
LOW GATE OPERATING CURRENT	$I_{D(off)} = 10pA$
FAST SWITCHING	$t_{(ON)} 25ns$

ABSOLUTE MAXIMUM RATINGS
@ 25°C (unless otherwise noted)

Maximum Temperatures

Storage Temperature	-55°C to +150°C
Operating Junction Temperature	-55°C to +135°C

Maximum Power Dissipation

Continuous Power Dissipation	350mW
------------------------------	-------

MAXIMUM CURRENT

Gate Current (Note 1)	$I_G = -50mA$
-----------------------	---------------

MAXIMUM VOLTAGES

Gate to Drain Voltage	$V_{GDS} = 30V$
Gate to Source Voltage	$V_{GSS} = 30V$

LSJ175 ELECTRICAL CHARACTERISTICS @ 25°C (unless otherwise noted)

SYMBOL	CHARACTERISTIC	MIN	TYP.	MAX	UNITS	CONDITIONS
BV_{GSS}	Gate to Source Breakdown Voltage	30	--	--	V	$I_G = -1\mu A, V_{DS} = 0V$
$V_{GS(F)}$	Gate to Source Forward Voltage	--	-0.7	--		$I_G = -1mA, V_{DS} = 0V$
$V_{GS(off)}$	Gate to Source Cutoff Voltage	3	--	6		$V_{DS} = -15V, I_D = -10nA$
I_{DSS}	Drain to Source Saturation Current	-7	--	-70	nA	$V_{DS} = -15V, V_{GS} = 0V$
I_{GSS}	Gate Reverse Current	--	0.01	1		$V_{GS} = 20V, V_{DS} = 0V$
I_G	Gate Operating Current	--	0.01	--		$V_{DG} = -15V, I_D = -1mA$
$I_{D(off)}$	Drain Cutoff Current	--	-0.01	-1		$V_{DS} = -15V, V_{GS} = 0V$
$r_{DS(on)}$	Drain to Source On Resistance	--	--	125		$V_{GS} = 0V, V_{DS} = -0.1V$

LSJ175 SWITCHING CHARACTERISTICS @ 25°C (unless otherwise noted)

SYMBOL	CHARACTERISTIC	UNITS	CONDITIONS
$t_{d(on)}$	Turn On Time	10	$V_{GS(L)} = 0V$ $V_{GS(H)} = 10V$ See Switching Circuit
t_r	Turn On Rise Time	15	
$t_{d(off)}$	Turn Off Time	10	
t_f	Turn Off Fall Time	20	

Note 1 - Absolute maximum ratings are limiting values above which LSJ175 serviceability may be impaired.

LSJ175 SWITCHING CIRCUIT PARAMETERS

V_{DD}	-6V
V_{GG}	12V
R_L	750Ω
R_G	220Ω
$I_{D(on)}$	-7mA

SOT-23 (Top View)

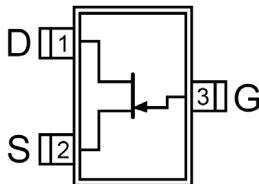

Available Packages:

LSJ175 in SOT-23
LSJ175 in bare die.

Please contact Micross for full package and die dimensions

SWITCHING CIRCUIT

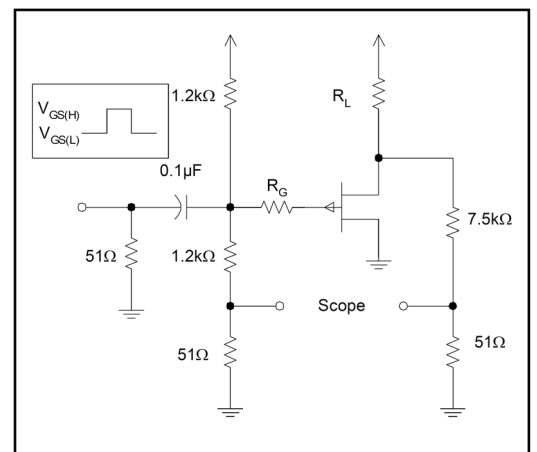

Micross Components Europe



Tel: +44 1603 788967

Email: chipcomponents@micross.com

Web: <http://www.micross.com/distribution>

Information furnished by Linear Integrated Systems and Micross Components is believed to be accurate and reliable. However, no responsibility is assumed for its use; nor for any infringement of patents or other rights of third parties which may result from its use. No license is granted by implication or otherwise under any patent or patent rights of Linear Integrated Systems.