

SKiiP 13AC12T4V1

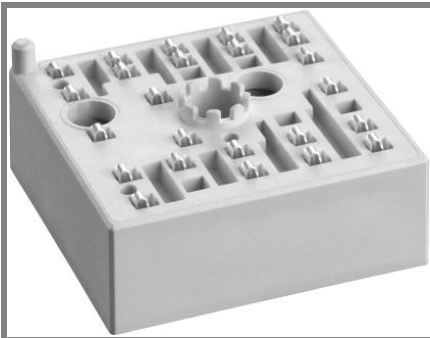

MiniSKiiP[®]1

3-phase bridge inverter

SKiiP 13AC12T4V1

Features

- Trench 4 IGBT's
- Robust and soft freewheeling diodes in CAL technology
- Highly reliable spring contacts for electrical connections
- UL recognised file no. E63532

Typical Applications*

- Inverter up to 14 kVA
- Typical motor power 7,5 kW

Remarks

- V_{CEsat} , V_F = chip level value
- Case temp. limited to $T_C = 125^\circ\text{C}$ max. (for baseplateless modules $T_C = T_S$)
- product rel. results valid for $T_j \leq 150$ (recomm. $T_{op} = -40 \dots +150^\circ\text{C}$)

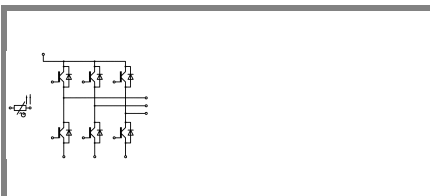

AC

Absolute Maximum Ratings		$T_C = 25^\circ\text{C}$, unless otherwise specified	
Symbol	Conditions	Values	Units
IGBT			
V_{CES}	$T_j = 25^\circ\text{C}$	1200	V
I_C	$T_j = 175^\circ\text{C}$	$T_C = 25^\circ\text{C}$	41 A
		$T_C = 70^\circ\text{C}$	34 A
I_{CRM}	$I_{CRM} = 3 \times I_{Cnom}$	75	A
V_{GES}		± 20	V
t_{psc}	$V_{CC} = 800\text{ V}; V_{GE} \leq 15\text{ V}; T_j = 150^\circ\text{C}$ $V_{CES} < 1200\text{ V}$	10	μs
Inverse Diode			
I_F	$T_j = 175^\circ\text{C}$	$T_C = 25^\circ\text{C}$	30 A
		$T_C = 70^\circ\text{C}$	26 A
I_{FRM}	$I_{CRM} = 3 \times I_{Cnom}$	75	A
I_{FSM}	$t_p = 10\text{ ms}; \text{sin.}$	$T_j = 150^\circ\text{C}$	100 A
Module			
$I_{t(RMS)}$		40	A
T_{vj}		-40...+175	$^\circ\text{C}$
T_{stg}		-40...+125	$^\circ\text{C}$
V_{isol}	AC, 1 min.	2500	V

Characteristics		$T_C = 25^\circ\text{C}$, unless otherwise specified				
Symbol	Conditions	min.	typ.	max.	Units	
IGBT						
$V_{GE(th)}$	$V_{GE} = V_{CE}, I_C = 1\text{ mA}$	5	5,8	6,5	V	
I_{CES}	$V_{GE} = V, V_{CE} = V_{CES}$		$T_j = 25^\circ\text{C}$	0,8	0,9	V
			$T_j = 150^\circ\text{C}$	0,7	0,8	V
r_{CE}	$V_{GE} = 15\text{ V}$					
			$T_j = 25^\circ\text{C}$	42	46	$\text{m}\Omega$
			$T_j = 150^\circ\text{C}$	62	66	$\text{m}\Omega$
$V_{CE(sat)}$	$I_{Cnom} = 25\text{ A}, V_{GE} = 15\text{ V}$		$T_j = 25^\circ\text{C}_{chiplev.}$	1,85	2,05	V
			$T_j = 150^\circ\text{C}_{chiplev.}$	2,25	2,45	V
C_{ies}	$V_{CE} = 25, V_{GE} = 0\text{ V}$	$f = 1\text{ MHz}$		1,43	nF	
C_{oes}			0,12	nF		
C_{res}			0,09	nF		
Q_G	$V_{GE} = -8 \dots +15\text{ V}$		140		nC	
R_{Gint}	$T_j = 25^\circ\text{C}$		0		Ω	
$t_{d(on)}$	$R_{Gon} = 39\ \Omega$ $di/dt = 465\text{ A}/\mu\text{s}$	$V_{CC} = 600\text{ V}$ $I_C = 25\text{ A}$		44	ns	
t_r			46	ns		
E_{on}			3,7	mJ		
$t_{d(off)}$	$R_{Goff} = 39\ \Omega$ $di/dt = 350\text{ A}/\mu\text{s}$	$T_j = 150^\circ\text{C}$ $V_{GE} = \pm 15\text{ V}$		330	ns	
t_f			62	ns		
E_{off}			2,4	mJ		
$R_{th(j-s)}$	per IGBT		1		K/W	

SKiiP 13AC12T4V1

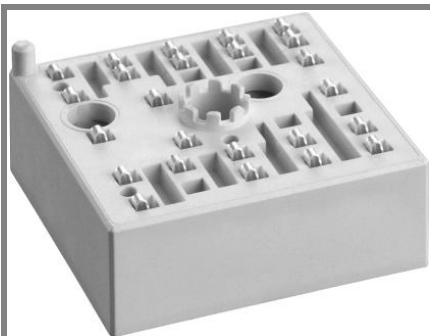

MiniSKiiP[®]1

3-phase bridge inverter

SKiiP 13AC12T4V1

Features

- Trench 4 IGBT's
- Robust and soft freewheeling diodes in CAL technology
- Highly reliable spring contacts for electrical connections
- UL recognised file no. E63532

Typical Applications*

- Inverter up to 14 kVA
- Typical motor power 7,5 kW

Remarks

- V_{CEsat} , V_F = chip level value
- Case temp. limited to $T_C = 125^\circ\text{C}$ max. (for baseplateless modules $T_C = T_S$)
- product rel. results valid for $T_j \leq 150$ (recomm. $T_{op} = -40 \dots +150^\circ\text{C}$)

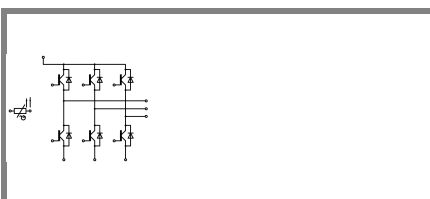

AC

Characteristics				min.	typ.	max.	Units
Symbol	Conditions						
Inverse Diode							
$V_F = V_{EC}$	$I_{Fnom} = 25 \text{ A}; V_{GE} = 0 \text{ V}$	$T_j = 25^\circ\text{C}_{\text{chiplev.}}$		2,4	2,75		V
		$T_j = 150^\circ\text{C}_{\text{chiplev.}}$		2,45	2,8		V
V_{F0}		$T_j = 25^\circ\text{C}$		1,3	1,5		V
		$T_j = 150^\circ\text{C}$		0,9	1,1		V
r_F		$T_j = 25^\circ\text{C}$		44	50		mΩ
		$T_j = 150^\circ\text{C}$		62	68		mΩ
I_{RRM}	$I_F = 25 \text{ A}$	$T_j = 150^\circ\text{C}$		19			A
Q_{rr}	$di/dt = 640 \text{ A}/\mu\text{s}$			4			μC
E_{rr}	$V_{GE} = \pm 15 \text{ V}$			1,64			mJ
$R_{th(j-s)}$	per diode			1,52			K/W
M_s	to heat sink			2	2,5		Nm
w				35			g
Temperature sensor							
R_{ts}	3%, $T_r = 25^\circ\text{C}$			1000			Ω
R_{ts}	3%, $T_r = 100^\circ\text{C}$			1670			Ω

This is an electrostatic discharge sensitive device (ESDS), international standard IEC 60747-1, Chapter IX.

* The specifications of our components may not be considered as an assurance of component characteristics. Components have to be tested for the respective application. Adjustments may be necessary. The use of SEMIKRON products in life support appliances and systems is subject to prior specification and written approval by SEMIKRON. We therefore strongly recommend prior consultation of our personal.

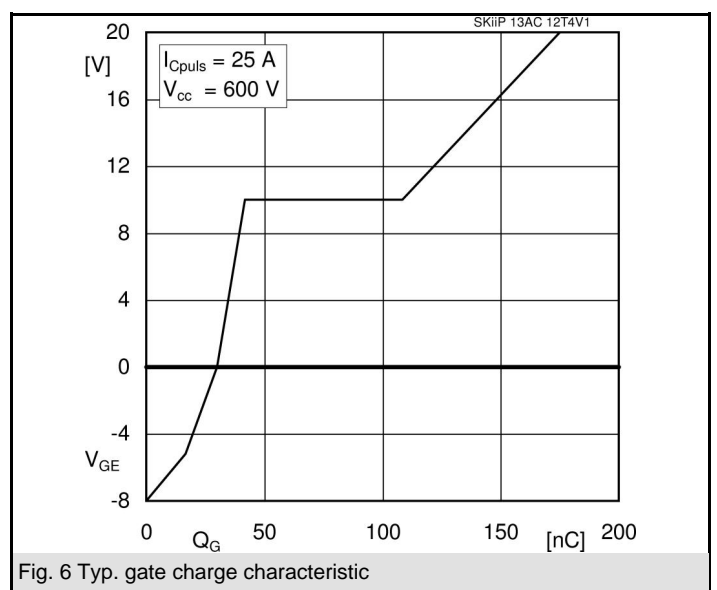
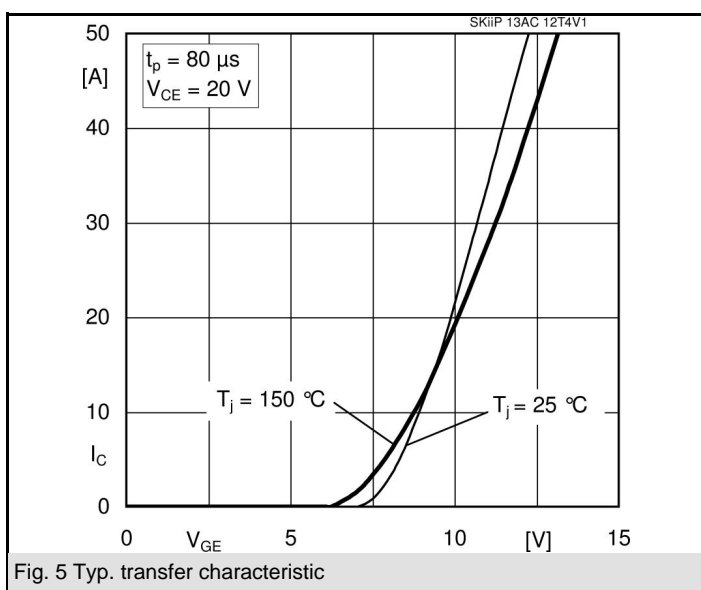
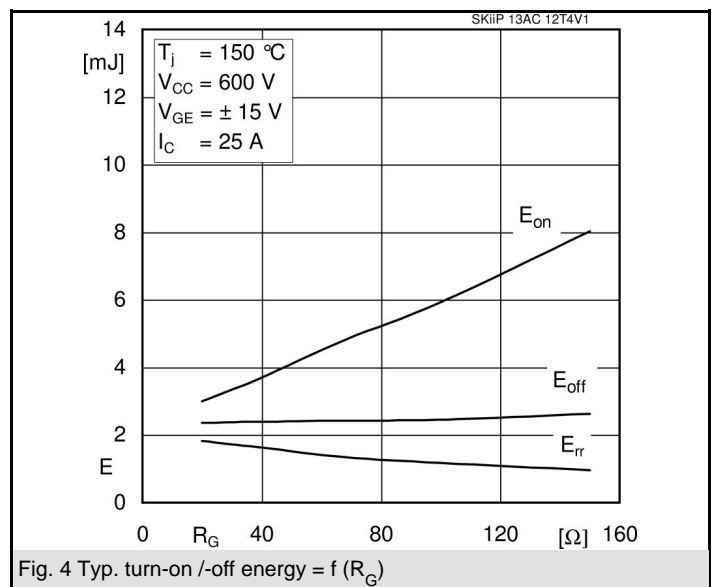
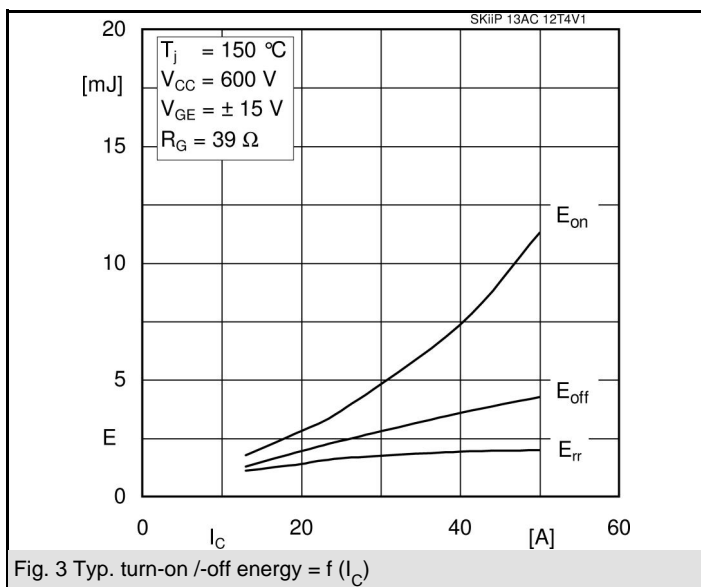
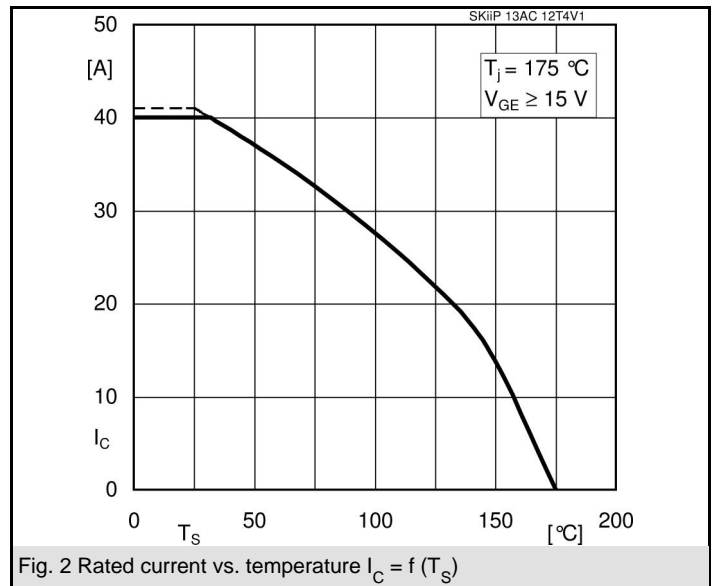
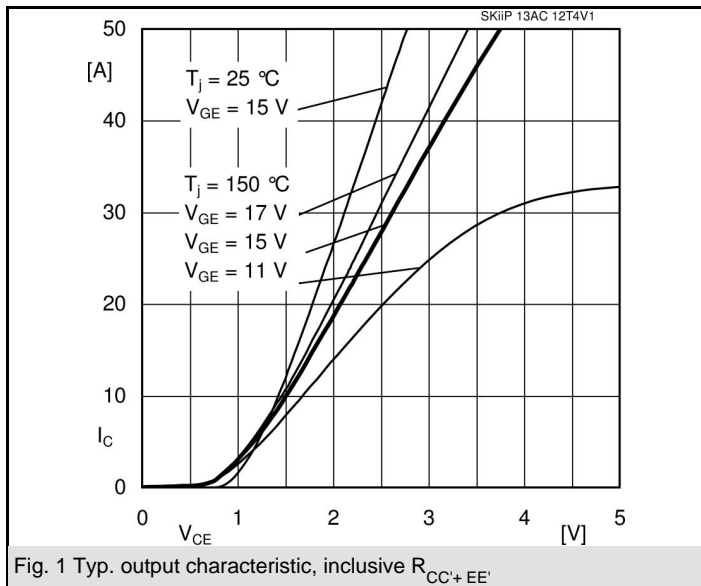

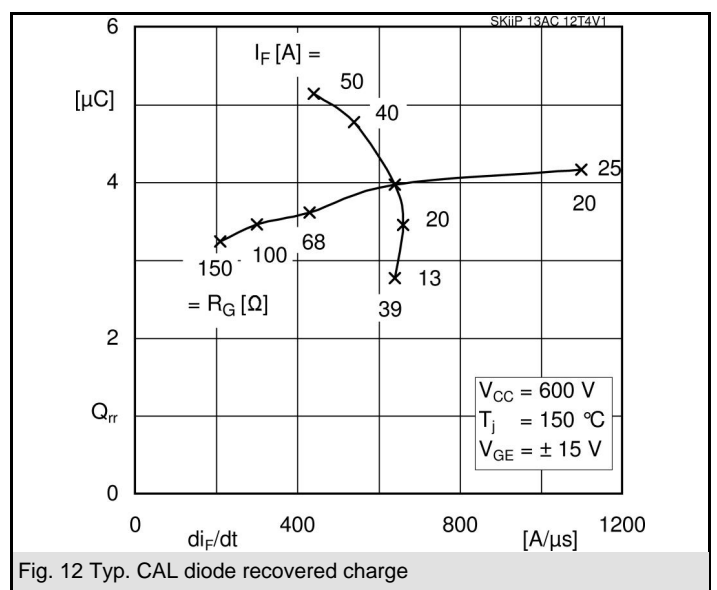
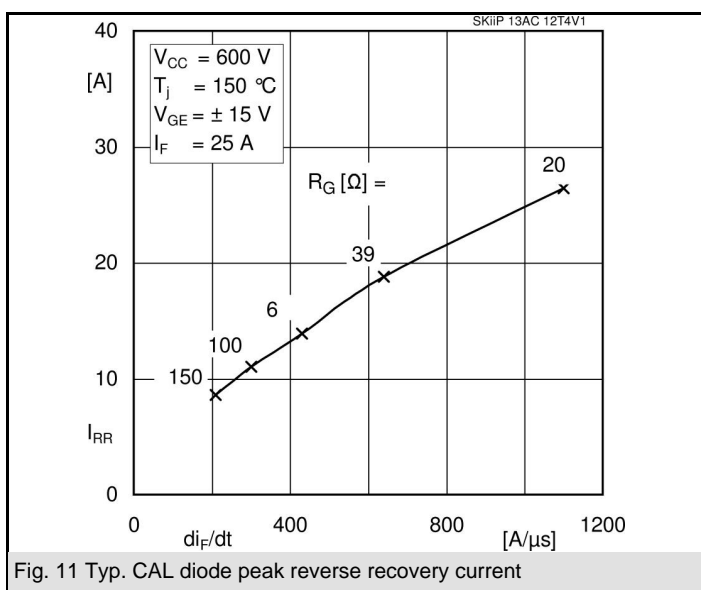
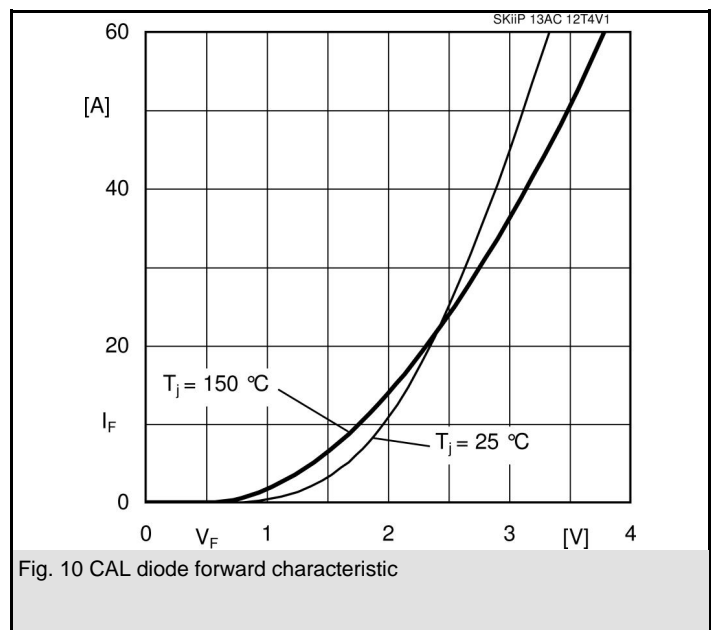
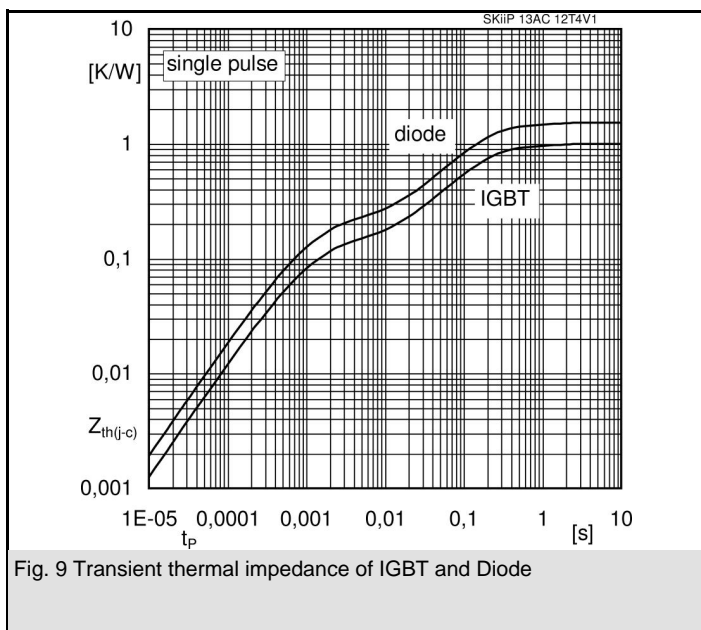
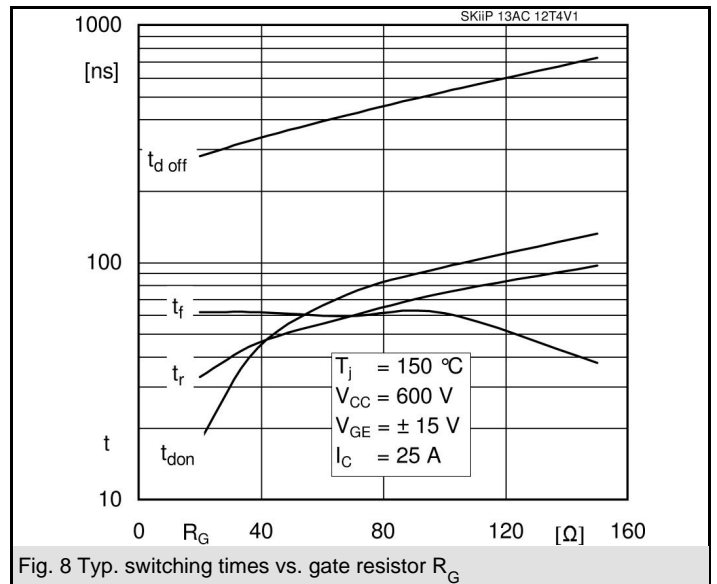
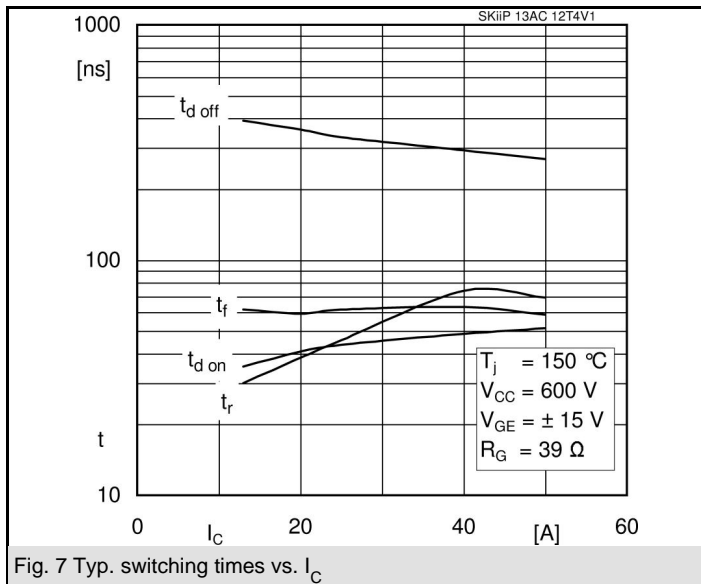

UL recognized file

no. E 63 532

PCB PCB TOP-VIEW

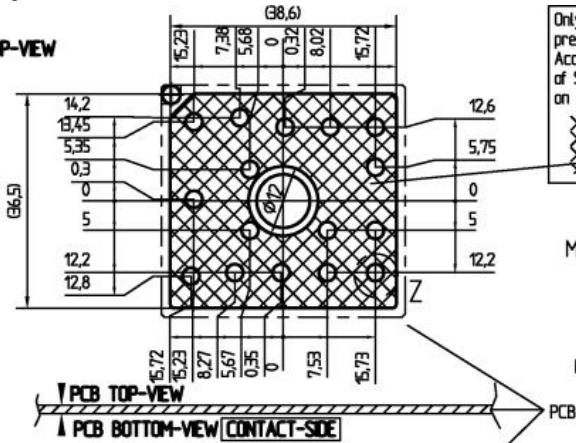

Only for the standard pressure part:
Accessible for mounting of SMD (max height 3.5) on PCB by customer

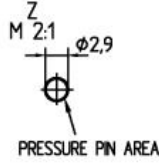

MiniSKiiP 1

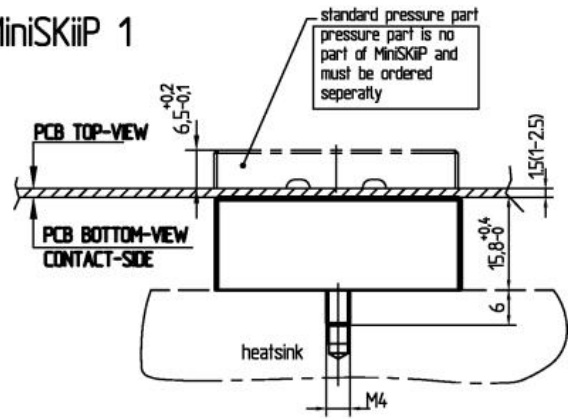

PCB BOTTOM-VIEW CONTACT-SIDE

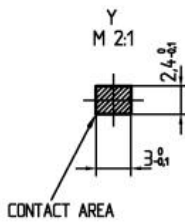
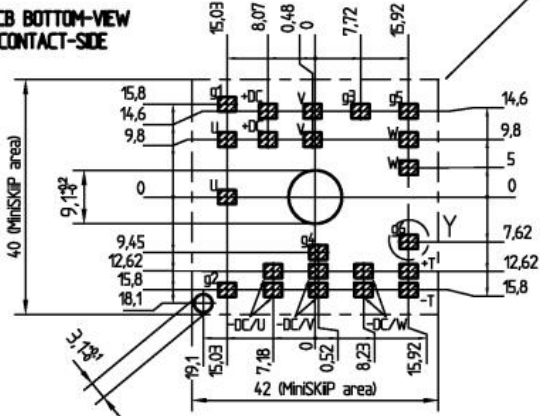

For mounting please follow the assembly instruction

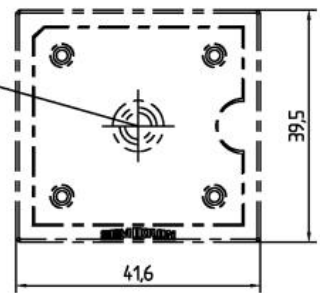

measure: mm
tolerance: ISO 2768-f

case

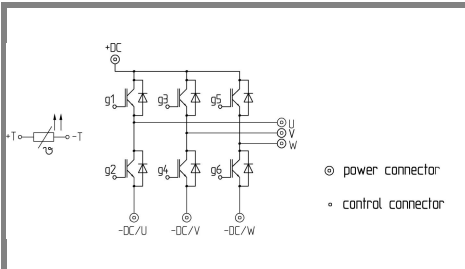

pinout