

1. PART NO. EXPRESSION :

SPS4010FT2R2N-□□

(a) (b) (c)(d) (e) (f) (g)

- (a) Series code
- (b) Dimension code
- (c) Powder coating type
- (d) Taping package

- (e) Inductance code : 2R2= 2.2uH
- (f) Tolerance code : M=±20%, N=±30%
- (g) 11~99 : Internal controlled number

2. CONFIGURATION & DIMENSIONS :

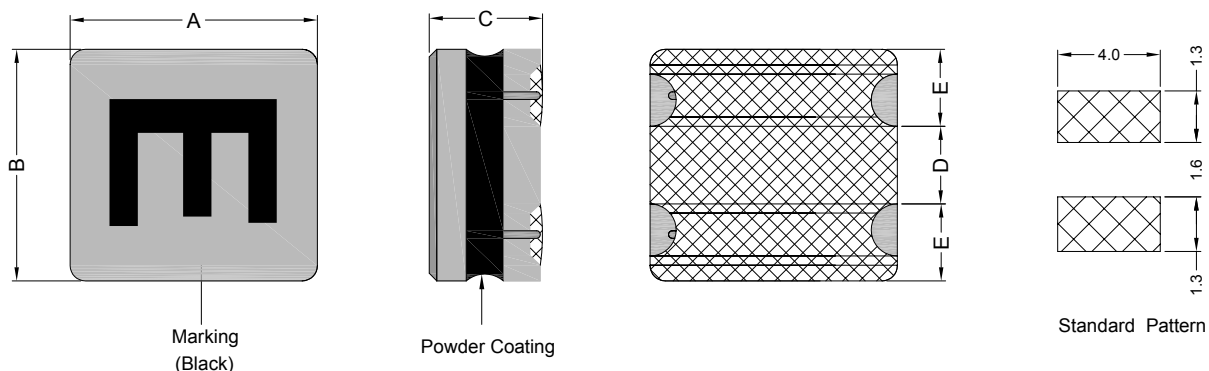

Unit:m/m

A	B	C	D	E
4.0±0.2	4.0±0.2	1.0 Max.	1.6 Typ	1.2 Typ

3. MATERIALS :

- (a) Core : Ferrite
- (b) Wire : Polyurethane Enamelled Copper Wire
- (c) Solder : M35E
- (d) Coating : Powder Coating
- (e) Ink : 70000-00101



RoHS Compliant

NOTE : Specifications subject to change without notice. Please check our website for latest information.

20.03.2012



4. GENERAL SPECIFICATION :

- a) IDC1 :Based on inductance change ($\Delta L/L_0$: $\pm 30\%$) @ ambient temp. 25°C
- b) IDC2 : Based on temperature rise (ΔT : 40°C TYP.)
- c) Rated DC Current: The less value which is IDC1 or IDC2.
- d) Storage temp. : -40°C to +105°C
- e) Operating temp. : -40°C to +105°C (include self temp. rise)
- f) Resistance to solder heat : 260°C 10secs

5. ELECTRICAL CHARACTERISTICS :

Part No.	Inductance (uH)	Test Frequency (Hz)	Resistance RDC (Ω) $\pm 20\%$	Rated DC Current		Marking
				IDC1 (A)	IDC2 (A)	
SPS4010FT1R0N	1.0 $\pm 30\%$	0.1V/1M	90m	1.80	1.05	A
SPS4010FT2R2N	2.2 $\pm 30\%$	0.1V/1M	0.14	1.15	0.89	E
SPS4010FT3R3M	3.3 $\pm 20\%$	0.1V/1M	0.16	1.10	0.82	G
SPS4010FT4R7M	4.7 $\pm 20\%$	0.1V/1M	0.21	0.90	0.75	I
SPS4010FT6R8M	6.8 $\pm 20\%$	0.1V/1M	0.28	0.74	0.62	K
SPS4010FT100M	10 $\pm 20\%$	0.1V/1M	0.38	0.56	0.60	M
SPS4010FT150M	15 $\pm 20\%$	0.1V/1M	0.51	0.47	0.51	O
SPS4010FT220M	22 $\pm 20\%$	0.1V/1M	0.82	0.36	0.40	Q
SPS4010FT330M	33 $\pm 20\%$	0.1V/1M	1.20	0.28	0.30	S



RoHS Compliant

NOTE : Specifications subject to change without notice. Please check our website for latest information.

20.03.2012



SUPERWORLD ELECTRONICS (S) PTE LTD

6. IMPEDANCE VS. FREQUENCY CURVES : :

6.1 INDUCTANCE vs. DC CURRENT

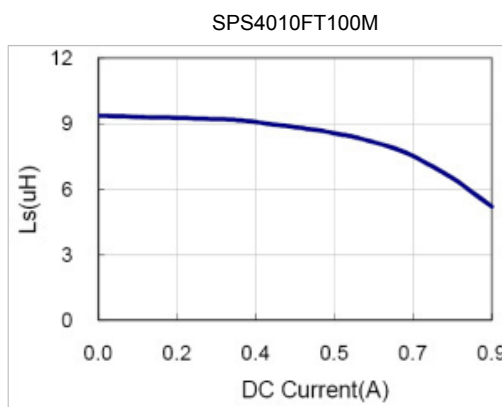
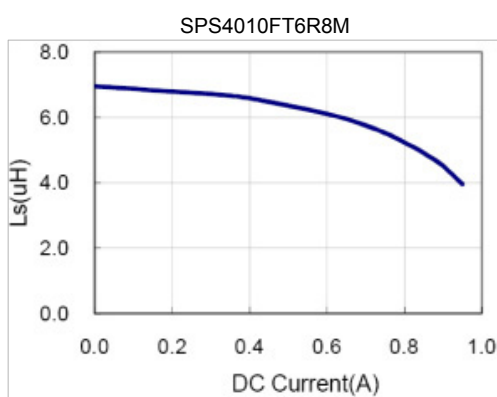
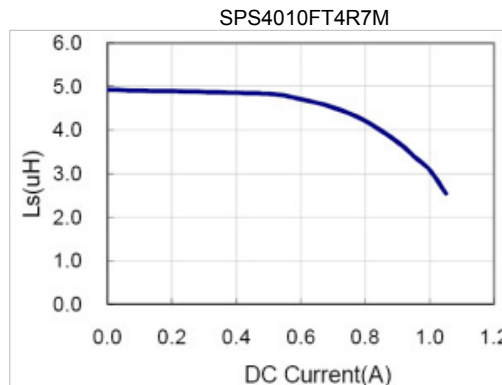
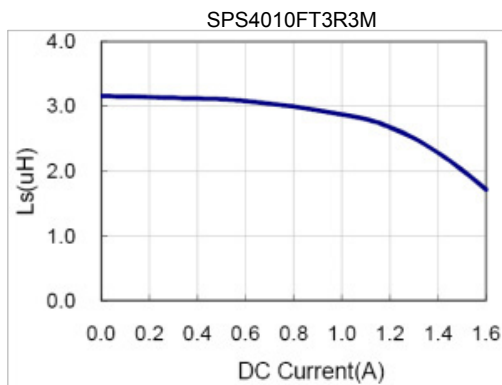
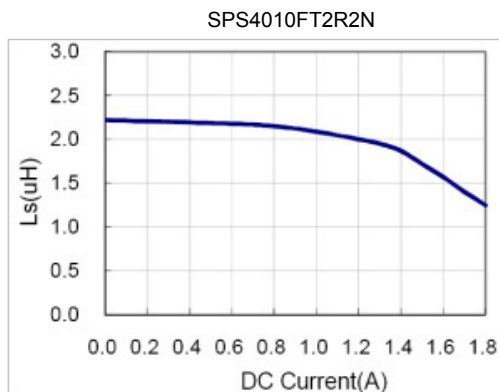
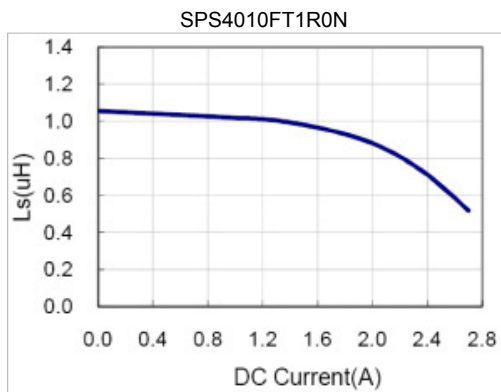

RoHS Compliant

NOTE : Specifications subject to change without notice. Please check our website for latest information.

20.03.2012



SUPERWORLD ELECTRONICS (S) PTE LTD

6. GENERAL SPECIFICATION :

6.1 INDUCTANCE vs. DC CURRENT

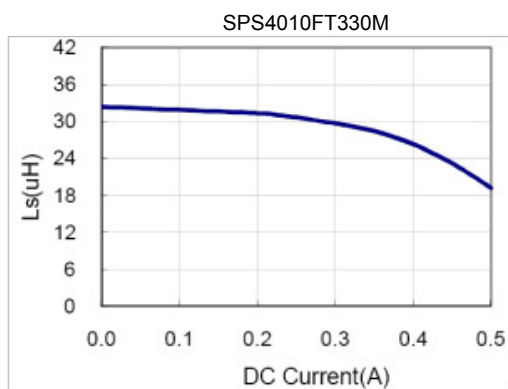
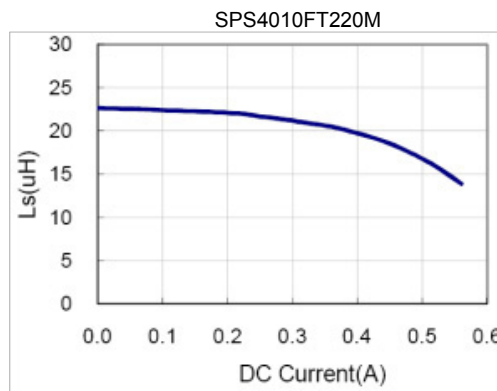
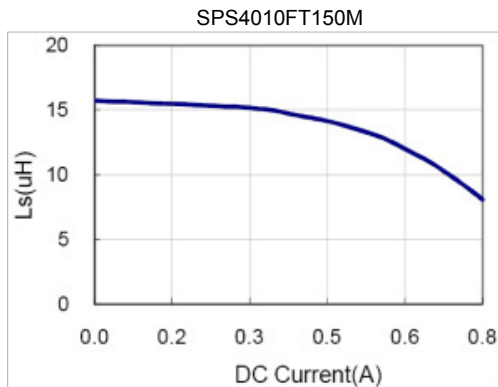

RoHS Compliant

NOTE : Specifications subject to change without notice. Please check our website for latest information.

20.03.2012



6. GENERAL SPECIFICATION :

6.2 TEMPERATURE vs. DC CURRENT

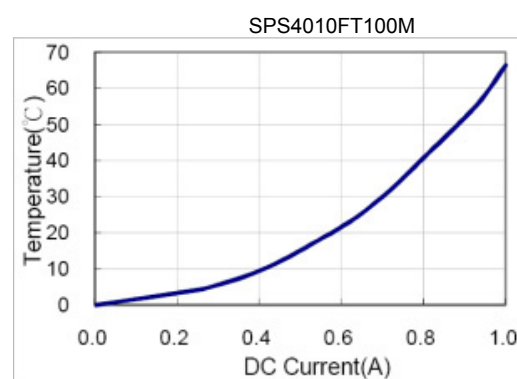
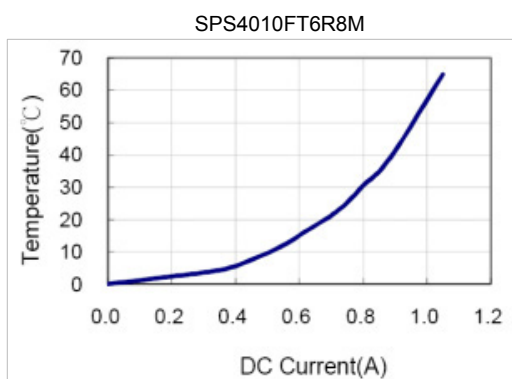
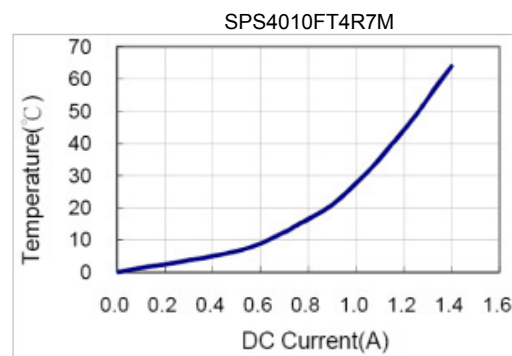
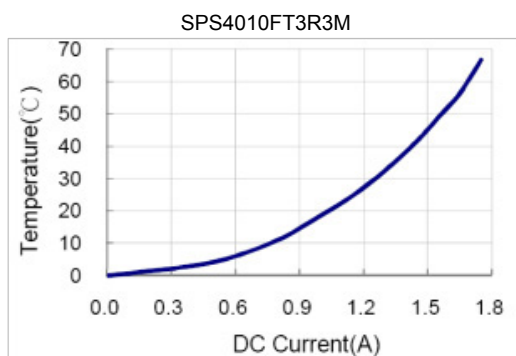
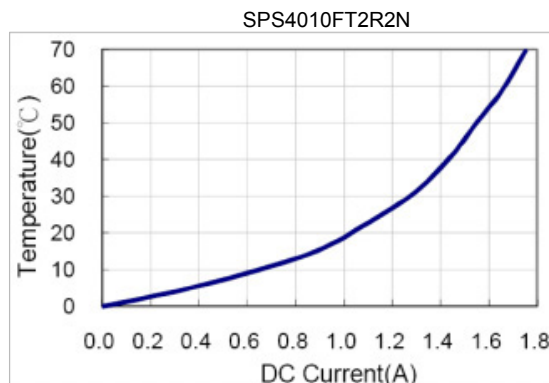
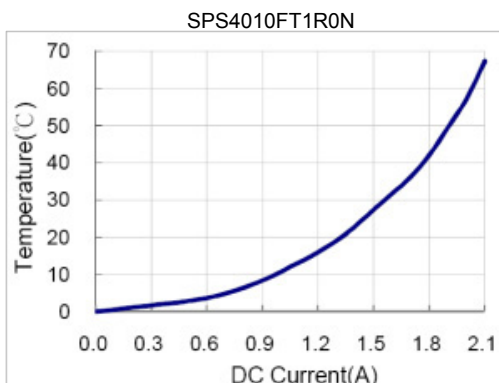

RoHS Compliant

NOTE : Specifications subject to change without notice. Please check our website for latest information.

20.03.2012



6. GENERAL SPECIFICATION :

6.2 TEMPERATURE vs. DC CURRENT

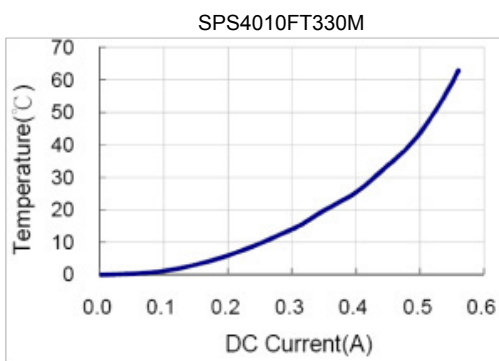
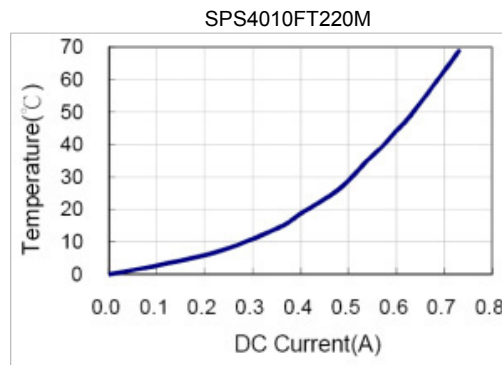
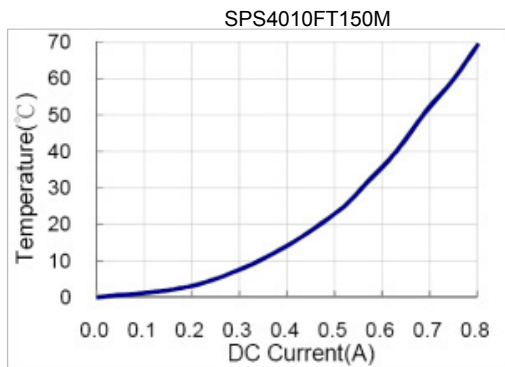

RoHS Compliant

NOTE : Specifications subject to change without notice. Please check our website for latest information.

20.03.2012

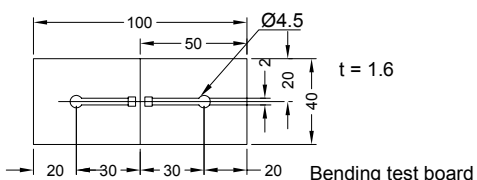
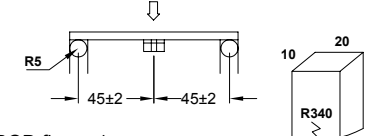
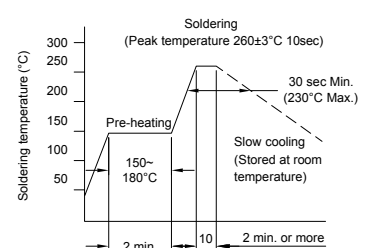

6. RELIABILITY & TEST CONDITION :

ITEM	PERFORMANCE	TEST CONDITION
Mechanical		
Substrate bending	$\Delta L/L_0 \leq \pm 10\%$ There shall be no mechanical damage or electrical damage.	The sample shall be soldered onto the printed circuit board in figure 1 and a load applied until the figure in the arrow direction is made approximately 3mm.(keep time 30 secs)   PRESSURE ROD figure-1
Vibration	$\Delta L/L_0 \leq \pm 10\%$ There shall be no mechanical damage.	The sample shall be soldered onto the printed circuit board and when a vibration having an amplitude of 1.52mm and a frequency of from 10 to 55Hz/1 minute repeated should be applied to the 3 directions (X,Y,Z) for 2 hours each. (A total of 6 hours)
Solderability	New solder More than 90%	Flux (rosin, isopropyl alcohol{JIS-K-1522}) shall be coated over the whole of the sample before hard, the sample shall then be preheated for about 2 minutes in a temperature of 130~150°C and after it has been immersed to a depth 0.5mm below for 3±0.2 seconds fully in molten solder M705 with a temperature of 245±5°C. More than 90% of the electrode sections shall be covered with new solder smoothly when the sample is taken out of the solder bath.
Resistance to Soldering heat (reflow soldering)	There shall be no damage or problems.	 The specimen shall be passed through the reflow oven with the condition shown in the above profile for 1 time. The specimen shall be stored at standard atmospheric conditions for 1 hour, after which the measurement shall be made.



RoHS Compliant

NOTE : Specifications subject to change without notice. Please check our website for latest information.

20.03.2012



6. RELIABILITY & TEST CONDITION :

ITEM	PERFORMANCE	TEST CONDITION															
Electrical Characteristics Test																	
Dielectric withstand voltage	There shall be no damage or problems.	AC 100V voltage shall be applied for 1 minute across the top surface and the terminal of this sample															
Temperature characteristics	$\Delta L/L20^{\circ}\text{C} \square \pm 10\%$ 0~2000 ppm/ $^{\circ}\text{C}$	The test shall be performed after the sample has stabilized in an ambient temperature of -20 to +85 $^{\circ}\text{C}$, and the value calculated based on the value applicable in a normal temperature and normal humidity shall be $\Delta L/L20^{\circ}\text{C} \square \pm 10\%$.															
High temperature storage	$\Delta L/L0 \square \pm 10\%$ There shall be no mechanical damage.	The sample shall be left for 96 ± 4 hours in an atmosphere with a temperature of 85 $\pm 2^{\circ}\text{C}$ and a normal humidity. Upon completion of the measurement shall be made after the sample has been left in a normal temperature and normal humidity for 1 hour.															
Low temperature storage	$\Delta L/L0 \square \pm 10\%$ There shall be no mechanical damage.	The sample shall be left for 96 ± 4 hours in an atmosphere with a temperature of -25 $\pm 3^{\circ}\text{C}$. Upon completion of the test, the measurement shall be made after the sample has been left in a normal temperature and normal humidity for 1 hour.															
Change of temperature	$\Delta L/L0 \square \pm 10\%$ There shall be no other damage of problems	The sample shall be subject to 5 continuous cycles, such as shown in the table 2 below and then it shall be subjected to standard atmospheric conditions for 1 hour, after which measurement shall be made. <table border="1" data-bbox="986 1205 1366 1473"> <thead> <tr> <th></th> <th>Temperature</th> <th>Duration</th> </tr> </thead> <tbody> <tr> <td>1</td> <td>-25$\pm 3^{\circ}\text{C}$ (Thermostat No.1)</td> <td>30 min.</td> </tr> <tr> <td>2</td> <td>Standard atmospheric</td> <td>5 sec. or less No.1\rightarrowNo.2</td> </tr> <tr> <td>3</td> <td>85$\pm 2^{\circ}\text{C}$ (Thermostat No.2)</td> <td>30 min.</td> </tr> <tr> <td>4</td> <td>Standard atmospheric</td> <td>5 sec. or less No.2\rightarrowNo.1</td> </tr> </tbody> </table>		Temperature	Duration	1	-25 $\pm 3^{\circ}\text{C}$ (Thermostat No.1)	30 min.	2	Standard atmospheric	5 sec. or less No.1 \rightarrow No.2	3	85 $\pm 2^{\circ}\text{C}$ (Thermostat No.2)	30 min.	4	Standard atmospheric	5 sec. or less No.2 \rightarrow No.1
	Temperature	Duration															
1	-25 $\pm 3^{\circ}\text{C}$ (Thermostat No.1)	30 min.															
2	Standard atmospheric	5 sec. or less No.1 \rightarrow No.2															
3	85 $\pm 2^{\circ}\text{C}$ (Thermostat No.2)	30 min.															
4	Standard atmospheric	5 sec. or less No.2 \rightarrow No.1															
Moisture storage	$\Delta L/L0 \square \pm 10\%$ There shall be no mechanical damage.	The sample shall be left for 96 ± 4 hours in a temperature of 40 $\pm 2^{\circ}\text{C}$ and a humidity(RH) of 90~95%. Upon completion of the test, the measurement shall be made after the sample has been left in a normal temperature and normal humidity more than 1 hour.															



RoHS Compliant

NOTE : Specifications subject to change without notice. Please check our website for latest information.

20.03.2012



SUPERWORLD ELECTRONICS (S) PTE LTD

7. PACKAGING INFORMATION :

7-1. Reel Dimension (mm)

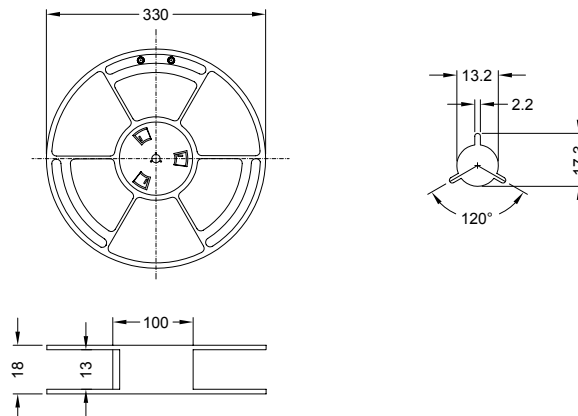

7-2 CARRIER TAPE DIMENSIONS (mm)

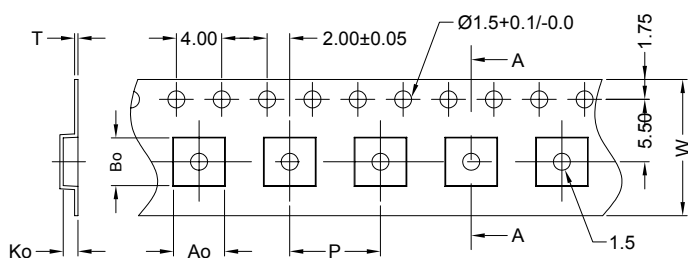

Ao	Bo	Ko	W	P	T
3.5mm	3.35mm	1.55mm	12mm	8.0mm	0.3mm

7-3 TAPING DIMENSIONS (mm)

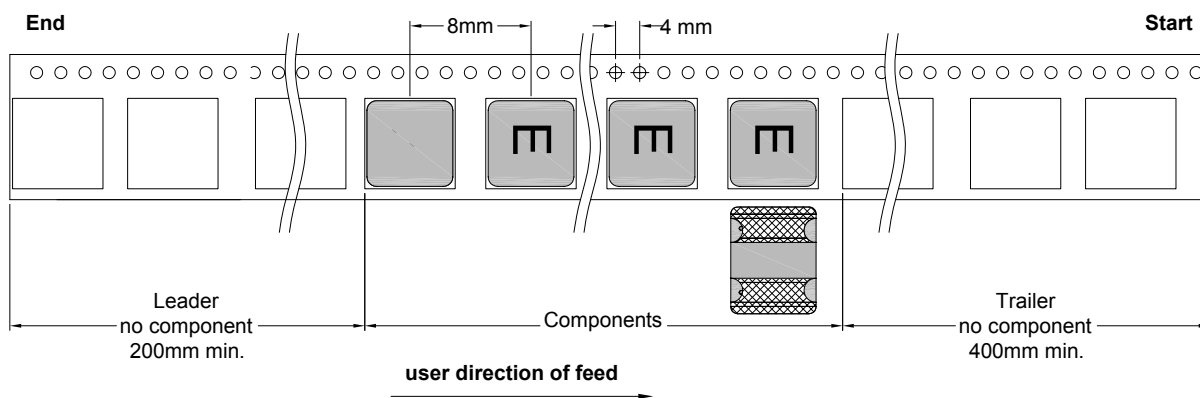

7-4 QUANTITY

3000pcs/Reel

The products are packaged so that no damage will be sustained.



RoHS Compliant

NOTE : Specifications subject to change without notice. Please check our website for latest information.

20.03.2012



SUPERWORLD ELECTRONICS (S) PTE LTD