

RoHS Compliant Product
A suffix of "-C" specifies halogen & lead-free

DESCRIPTION

These miniature surface mount MOSFETs utilize a high cell density trench process to provide low $R_{DS(on)}$ and to ensure minimal power loss and heat dissipation.

FEATURES

- Low $R_{DS(on)}$ provides higher efficiency and extends battery life
- Low thermal impedance copper leadframe DFN3x3-8PP saves board space
- Fast switching speed
- High performance trench technology

APPLICATION

DC-DC converters and power management in portable and battery-powered products such as computers, printers, PCMCIA cards, cellular and cordless telephones.

PACKAGE INFORMATION

Package	MPQ	Leader Size
DFN3x3-8PP	3K	13 inch

Top View

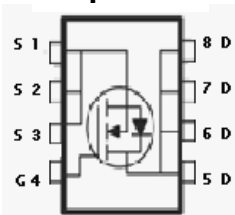

REF.	Millimeter		REF.	Millimeter	
	Min.	Max.		Min.	Max.
A	0.70	0.90	θ	0°	12°
B	3.00BSC		b	0.20	0.40
C	0.10	0.25	d	0.65BSC	
D	1.80	2.3	e	3.00BSC	
E	3.2BSC		g	0.70(TYP.)	
F	0.01	0.02			
G	2.35BSC				

DFN3x3-8PP

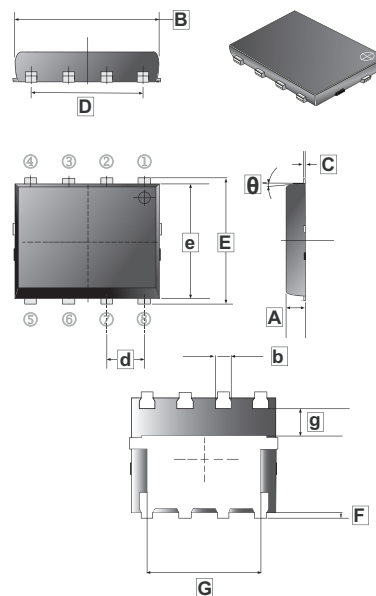

MAXIMUM RATINGS ($T_A = 25^\circ\text{C}$ unless otherwise specified)

Parameter	Symbol	Ratings	Unit	
Drain-Source Voltage	V_{DS}	30	V	
Gate-Source Voltage	V_{GS}	±20	V	
Continuous Drain Current ¹	I_D	$T_A = 25^\circ\text{C}$	17	A
		$T_A = 70^\circ\text{C}$	12	A
Pulsed Drain Current ²	I_{DM}	40	A	
Continuous Source Current (Diode Conduction) ¹	I_S	2	A	
Total Power Dissipation ¹	P_D	$T_A = 25^\circ\text{C}$	3.5	W
		$T_A = 70^\circ\text{C}$	2.0	W
Operating Junction & Storage Temperature Range	T_J, T_{STG}	-55~150	°C	
Thermal Resistance Ratings				
Thermal Resistance Junction-Case (Max.) ¹	$t \leq 5 \text{ sec}$	$R_{\theta JC}$	25	°C / W
Thermal Resistance Junction-Ambient (Max.) ¹	$t \leq 5 \text{ sec}$	$R_{\theta JA}$	50	°C / W

Notes:

1. Surface Mounted on 1" x 1" FR4 Board.
2. Pulse width limited by maximum junction temperature.

ELECTRICAL CHARACTERISTICS ($T_A = 25^\circ\text{C}$ unless otherwise specified)

Parameter	Symbol	Min.	Typ.	Max.	Unit	Test Conditions
Static						
Gate-Threshold Voltage	$V_{GS(th)}$	1	-	3	V	$V_{DS}=V_{GS}$, $I_D=250\mu\text{A}$
Gate-Body Leakage Current	I_{GSS}	-	-	±100	nA	$V_{DS}=0$, $V_{GS}=20\text{V}$
Zero Gate Voltage Drain Current	I_{DSS}	-	-	1	μA	$V_{DS}=24\text{V}$, $V_{GS}=0$
		-	-	25		$V_{DS}=24\text{V}$, $V_{GS}=0$, $T_J=55^\circ\text{C}$
On-State Drain Current ¹	$I_{D(on)}$	20	-	-	A	$V_{DS}=5\text{V}$, $V_{GS}=10\text{V}$
Drain-Source On-Resistance ¹	$R_{DS(ON)}$	-	-	8.5	mΩ	$V_{GS}=10\text{V}$, $I_D=10\text{A}$
		-	-	11.5		$V_{GS}=4.5\text{V}$, $I_D=8\text{A}$
Forward Transconductance ¹	g_{fs}	-	40	-	S	$V_{DS}=15\text{V}$, $I_D=10\text{A}$
Diode Forward Voltage	V_{SD}	-	0.7	-	V	$I_S=2.3\text{A}$, $V_{GS}=0$
Dynamic ²						
Total Gate Charge	Q_g	-	11	-	nC	$V_{DS}=15\text{V}$, $V_{GS}=4.5\text{V}$, $I_D=10\text{A}$
Gate-Source Charge	Q_{gs}	-	6	-		
Gate-Drain Charge	Q_{gd}	-	4	-		
Input Capacitance	C_{iss}	-	1302	-	pF	$V_{DS}=15\text{V}$, $V_{GS}=0$ $f=1\text{MHz}$
Output Capacitance	C_{oss}	-	423	-		
Reverse Transfer Capacitance	C_{rss}	-	171	-		
Turn-On Delay Time	$T_{d(on)}$	-	10	-	nS	$V_{DD}=25\text{V}$ $I_D=1\text{A}$ $V_{GEN}=10\text{V}$ $R_L=25\Omega$
Rise Time	T_r	-	5	-		
Turn-Off Delay Time	$T_{d(off)}$	-	22	-		
Fall Time	T_f	-	4	-		

Notes:

1. Pulse test : $PW \leq 300\mu\text{s}$ duty cycle $\leq 2\%$.
2. Guaranteed by design, not subject to production testing.

CHARACTERISTIC CURVE

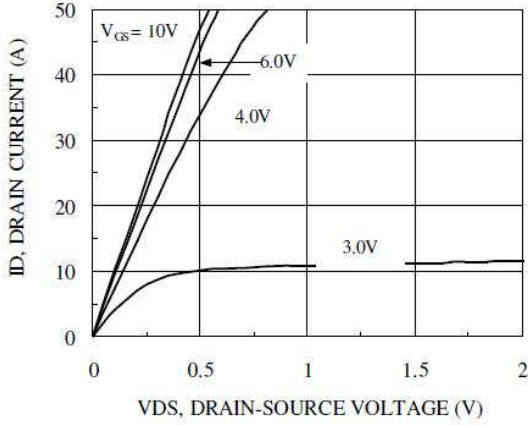

Figure 1. On-Region Characteristics

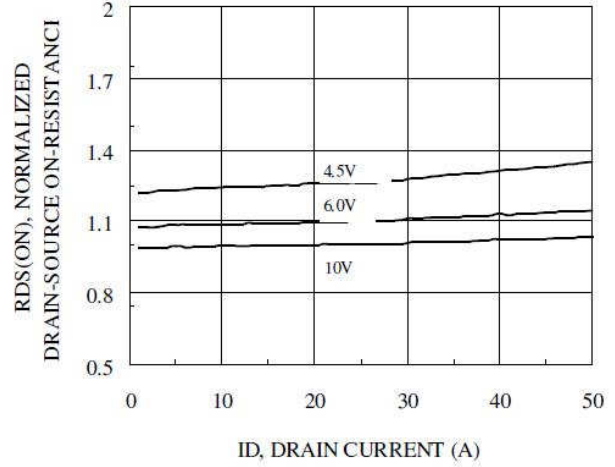

Figure 2. On-Resistance with Drain Current

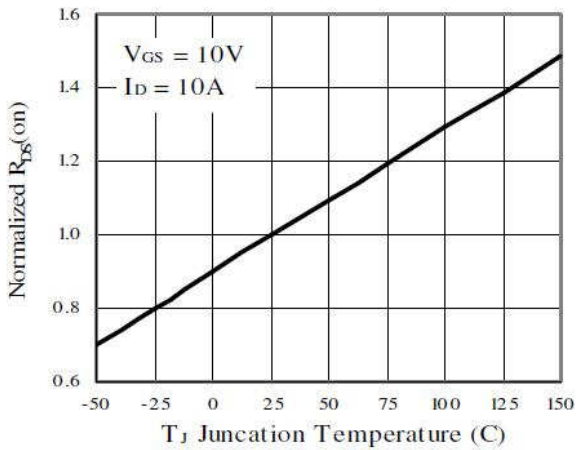

Figure 3. On-Resistance Variation with Temperature

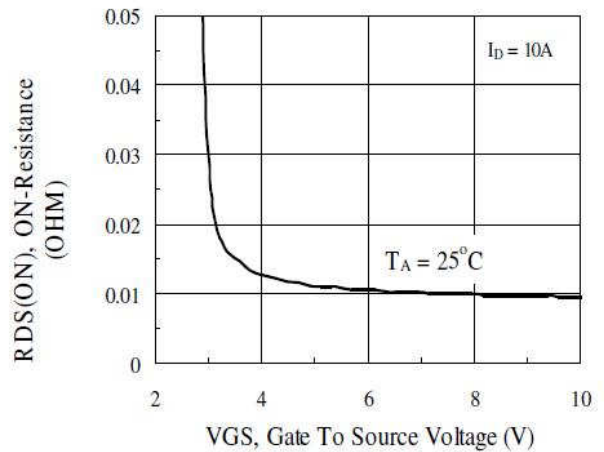

Figure 4. On-Resistance Variation with Gate to Source Voltage

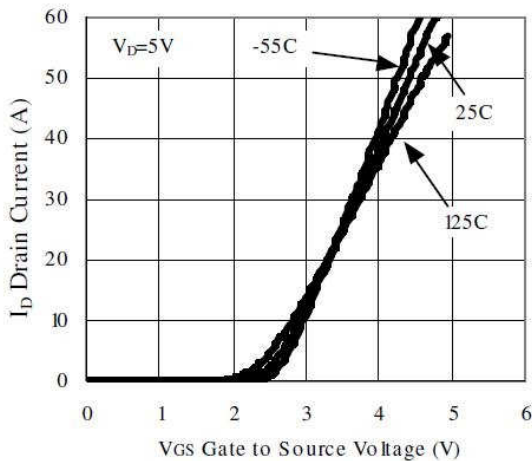

Figure 5. Transfer Characteristics

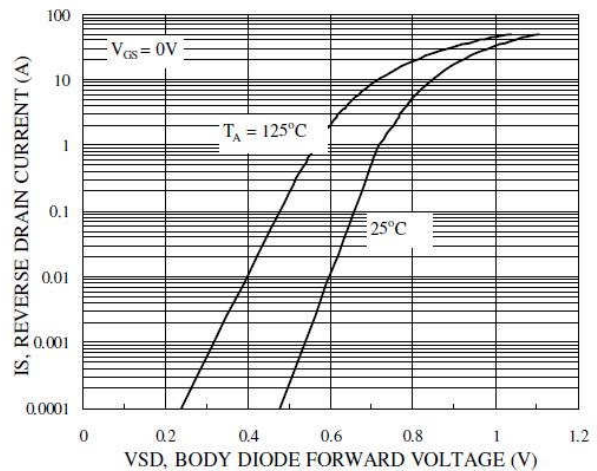

Figure 6. Body Diode Forward Voltage Variation with Source Current and Temperature

CHARACTERISTIC CURVE

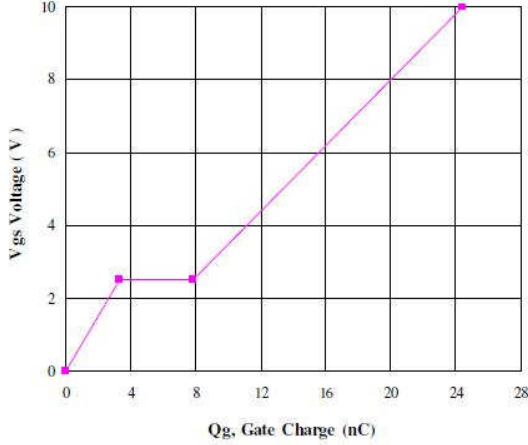

Figure 7. Gate Charge Characteristics

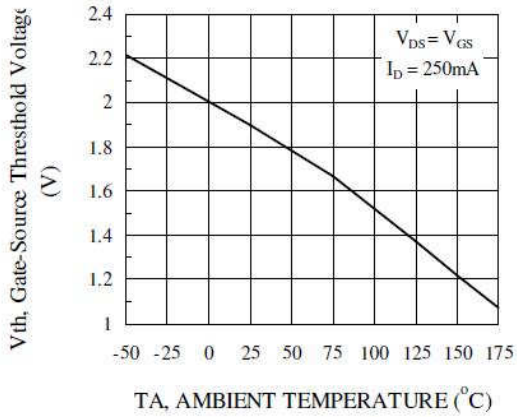

Figure 9. Threshold Vs Ambient Temperature

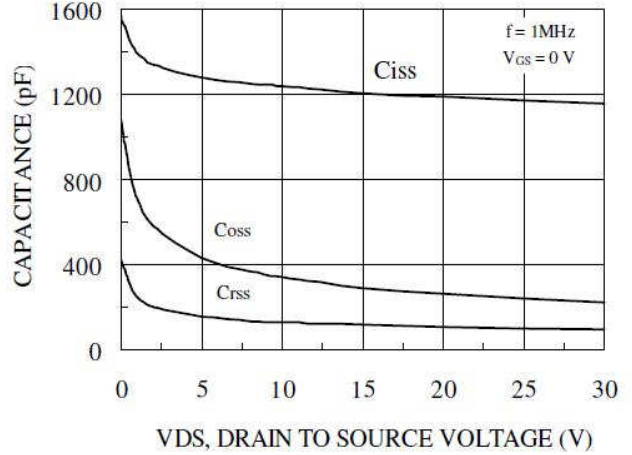

Figure 8. Capacitance Characteristics

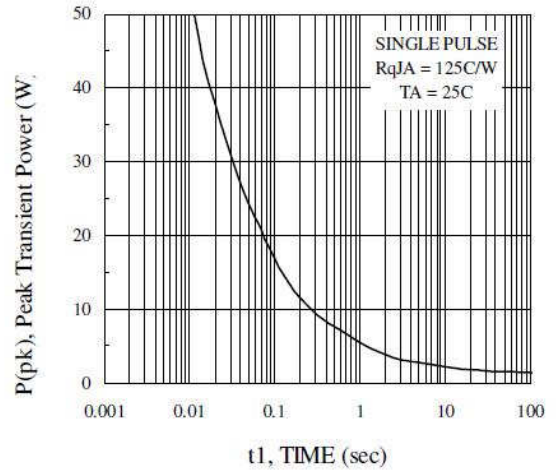

Figure 10. Single Pulse Maximum Power Dissipation

Normalized Thermal Transient Junction to Ambient

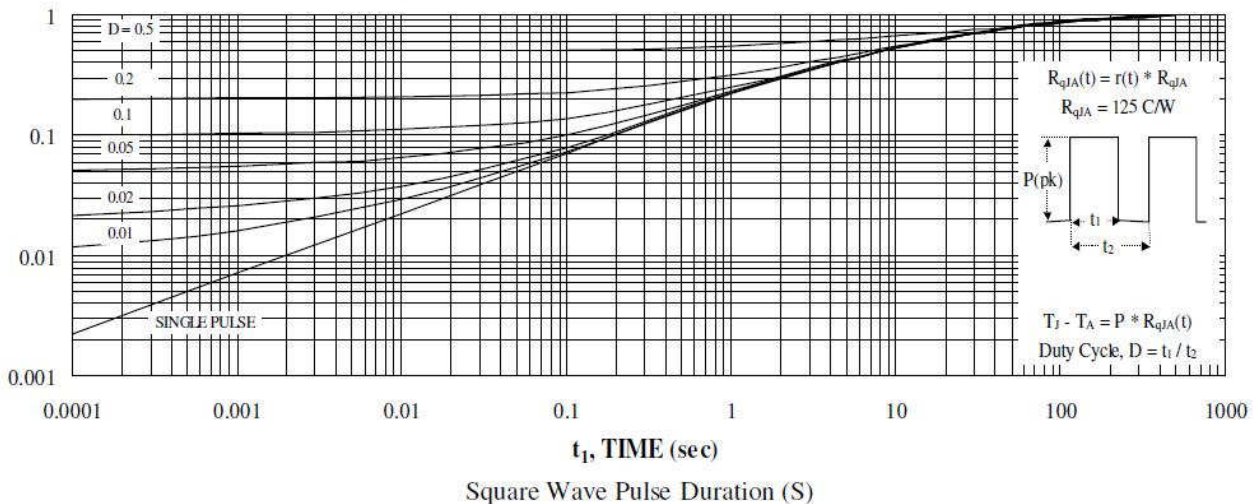

Figure 11. Transient Thermal Response Curve