

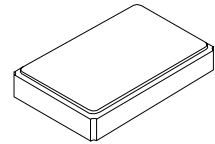



XTL1016

**48.53000 MHz
Crystal Unit**



SM2520-4 Case

- **Ultra-miniature Surface Mount Seam-weld Package**
- **Good Frequency Stability over Temperature**
- **Excellent Reliability**
- **Complies with Directive 2002/95/EC (RoHS)** 

The XTL1016 is a surface mount 2.5 x 2.0 x 0.6 mm crystal unit for use in wireless telecommunications devices, especially where an ultra-miniature package is needed for mobility.

Electrical Characteristics

Characteristic	Sym	Notes	Minimum	Typical	Maximum	Units
Nominal Frequency	F_O			48.53000		MHz
Load Capacitance	C_L			12		pF
Mode of Vibration			Fundamental			
Drive Level				10		uW
Frequency Make Tolerance	F_L		± 30 ppm @ 25 °C ± 3 °C			ppm
Resistance	ESR				50	Ω
Static Shunt Capacitance	C_O				2	pF
Frequency Stability Over Operating Temperature Range			± 30 ppm (referred to the value at 25 °C)			
Storage Temperature Range			-40		85	°C
Operating Temperature Range			-40		85	°C
Aging			1 ppm/year			
Standard Shipping Quantity on 178 mm (7") Reel				3000		units
Lid Symbolization (in addition to Lot and/or Date Codes)			2H YW			

Crystal Equivalent Circuit

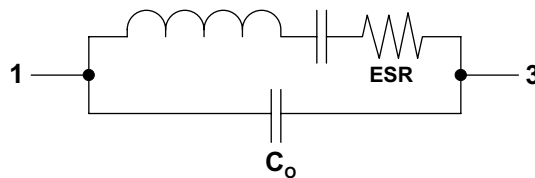

CAUTION: Electrostatic Sensitive Device. Observe precautions for handling.

Notes:

1. The design, manufacturing process, and specifications of this device are subject to change without notice.

SM2520-4 Case

4-Terminal Surface-Mount Case 2.5 x 2.0 mm Nominal Footprint

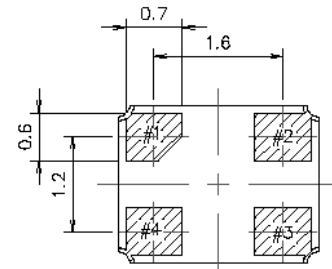
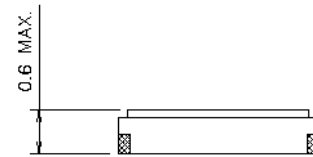
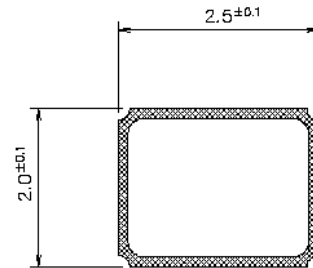
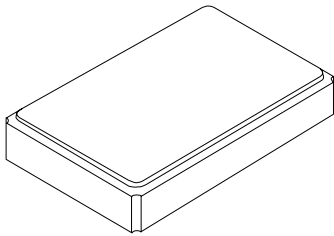

Electrical Connections

Pin	Connection
1	IN/OUT
2	GND
3	IN/OUT
4	GND

Package Dimensions (mm)

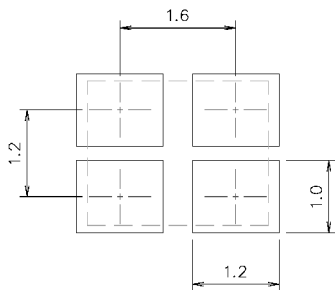

Land Pattern (mm)

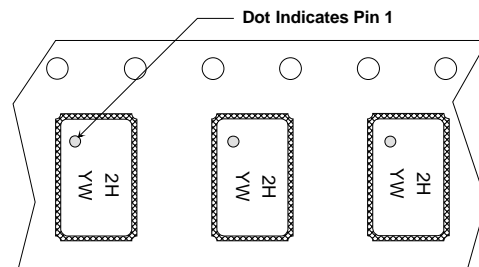

Package Orientation in Carrier Tape

Reel Dimensions

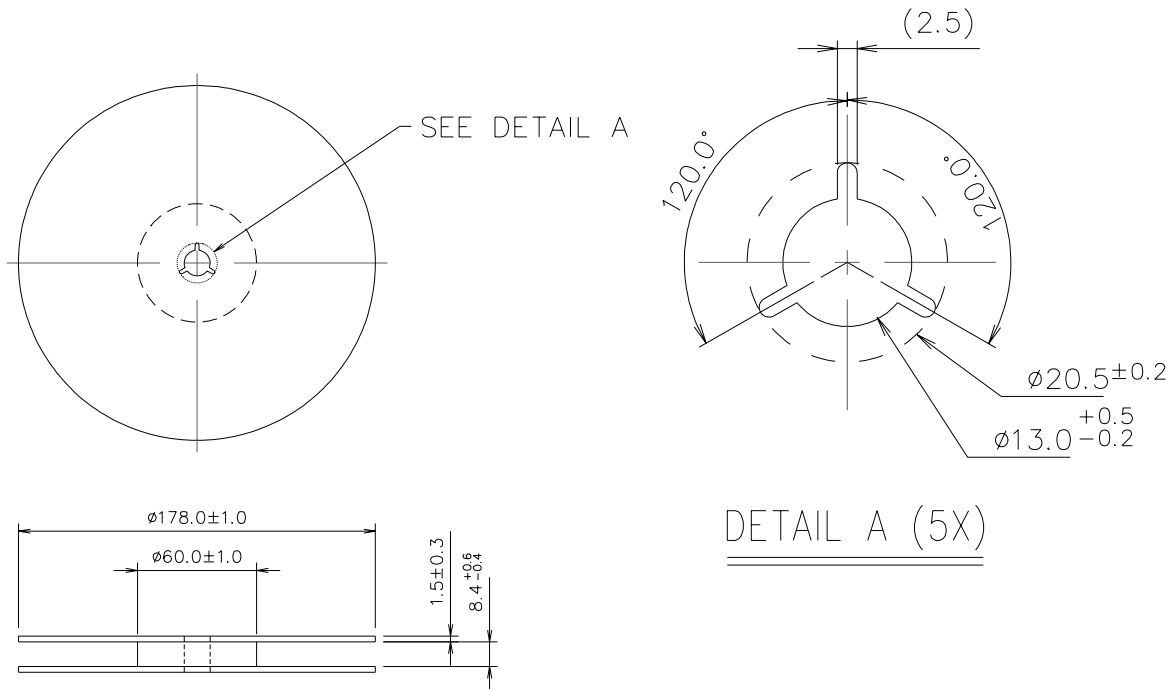

Tape Dimensions

