

SKM 200GB176D

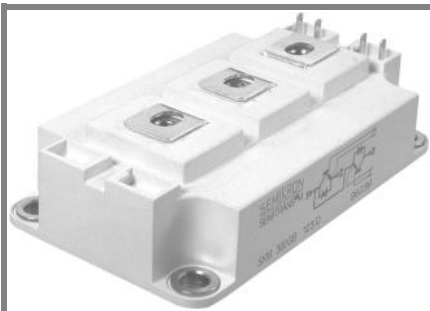

SEMITRANS® 3

Trench IGBT Modules

SKM 200GB176D

SKM 200GAL176D

Features

- Homogeneous Si
- Trench = Trenchgate technology
- V_{CEsat} with positive temperature coefficient
- High short circuit capability, self limiting to $6 \times I_C$

Typical Applications*

- AC inverter drives mains 575 - 750 V AC
- Public transport (auxiliary syst.)

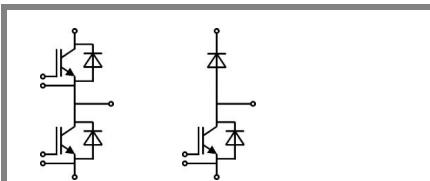

GB

GAL

Absolute Maximum Ratings		$T_c = 25\text{ °C}$, unless otherwise specified		
Symbol	Conditions	Values		Units
IGBT				
V_{CES}	$T_j = 25\text{ °C}$	1700		V
I_C	$T_j = 150\text{ °C}$	$T_c = 25\text{ °C}$	260	A
		$T_c = 80\text{ °C}$	180	A
I_{CRM}	$I_{CRM} = 2 \times I_{Cnom}$	300		A
V_{GES}		± 20		V
t_{psc}	$V_{CC} = 1200\text{ V}; V_{GE} \leq 20\text{ V}; T_j = 125\text{ °C}$ $V_{CES} < 1700\text{ V}$	10		µs
Inverse Diode				
I_F	$T_j = 150\text{ °C}$	$T_c = 25\text{ °C}$	210	A
		$T_c = 80\text{ °C}$	140	A
I_{FRM}	$I_{FRM} = 2 \times I_{Fnom}$	300		A
I_{FSM}	$t_p = 10\text{ ms}; \sin.$	$T_j = 150\text{ °C}$	1100	A
Freewheeling Diode				
I_F	$T_j = 150\text{ °C}$	$T_{case} = 25\text{ °C}$	210	A
		$T_{case} = 80\text{ °C}$	140	A
I_{FRM}	$I_{FRM} = 2 \times I_{Fnom}$	300		A
I_{FSM}	$t_p = 10\text{ ms}; \sin.$	$T_j = 150\text{ °C}$	1100	A
Module				
$I_{t(RMS)}$		500		A
T_{vj}		- 40 ... + 150		°C
T_{stg}		-40...+125		°C
V_{isol}	AC, 1 min.	4000		V

Characteristics		$T_c = 25\text{ °C}$, unless otherwise specified			
Symbol	Conditions	min.	typ.	max.	Units
IGBT					
$V_{GE(th)}$	$V_{GE} = V_{CE}, I_C = 6\text{ mA}$	5,2	5,8	6,4	V
I_{CES}	$V_{GE} = 0\text{ V}, V_{CE} = V_{CES}$			3	mA
V_{CE0}		$T_j = 25\text{ °C}$	1	1,2	V
		$T_j = 125\text{ °C}$	0,9	1,1	V
r_{CE}	$V_{GE} = 15\text{ V}$	$T_j = 25\text{ °C}$	6,7	8,3	mΩ
		$T_j = 125\text{ °C}$	10	12	mΩ
$V_{CE(sat)}$	$I_{Cnom} = 150\text{ A}, V_{GE} = 15\text{ V}$	$T_j = 25\text{ °C}_{chiplev.}$	2	2,45	V
		$T_j = 125\text{ °C}_{chiplev.}$	2,4	2,9	V
C_{ies}	$V_{CE} = 25, V_{GE} = 0\text{ V}$	$f = 1\text{ MHz}$	11,4		nF
C_{oes}			0,55		nF
C_{res}			0,44		nF
Q_G	$V_{GE} = -8V...+15V$	1200		nC	
R_{Gint}	$T_j = 25\text{ °C}$	4,25		Ω	
$t_{d(on)}$	$R_{Gon} = 5\text{ Ω}$	$V_{CC} = 1200V$ $I_C = 150A$	360		ns
			$T_j = 125\text{ °C}$	45	ns
E_{on}	$R_{Goff} = 5\text{ Ω}$	$V_{GE} = \pm 15V$	93		mJ
$t_{d(off)}$			760		ns
t_f			140		ns
E_{off}			58		mJ
$R_{th(j-c)}$	per IGBT			0,12	K/W

SKM 200GB176D

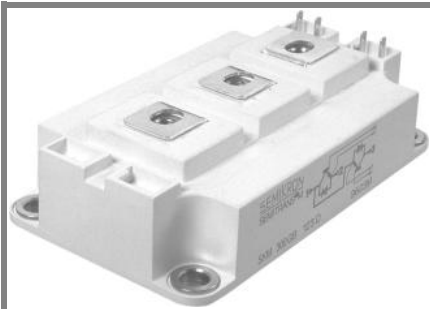

SEMITRANS® 3

Trench IGBT Modules

SKM 200GB176D

SKM 200GAL176D

Features

- Homogeneous Si
- Trench = Trenchgate technology
- V_{CEsat} with positive temperature coefficient
- High short circuit capability, self limiting to $6 \times I_c$

Typical Applications*

- AC inverter drives mains 575 - 750 V AC
- Public transport (auxiliary syst.)

Characteristics				min.	typ.	max.	Units
Symbol	Conditions						
Inverse Diode							
$V_F = V_{EC}$	$I_{Fnom} = 150 \text{ A}; V_{GE} = 0 \text{ V}$	$T_j = 25 \text{ }^\circ\text{C}_{chiplev.}$		1,7	1,9		V
		$T_j = 125 \text{ }^\circ\text{C}_{chiplev.}$		1,7	1,9		V
V_{F0}		$T_j = 25 \text{ }^\circ\text{C}$		1,1	1,3		V
		$T_j = 125 \text{ }^\circ\text{C}$		0,9	1,1		V
r_F		$T_j = 25 \text{ }^\circ\text{C}$		4	4		mΩ
		$T_j = 125 \text{ }^\circ\text{C}$		5,3	5,3		mΩ
I_{RRM}	$I_F = 150 \text{ A}$	$T_j = 125 \text{ }^\circ\text{C}$		195			A
Q_{rr}	$di/dt = 3700 \text{ A}/\mu\text{s}$			52			μC
E_{rr}	$V_{GE} = -15 \text{ V}; V_{CC} = 1200 \text{ V}$			31			mJ
$R_{th(j-c)D}$	per diode				0,25		K/W
FWD							
$V_F = V_{EC}$	$I_{Fnom} = 150 \text{ A}; V_{GE} = 0 \text{ V}$	$T_j = 25 \text{ }^\circ\text{C}_{chiplev.}$		1,7	1,9		V
		$T_j = 125 \text{ }^\circ\text{C}_{chiplev.}$		1,7	1,9		V
V_{F0}		$T_j = 25 \text{ }^\circ\text{C}$		1,1	1,3		V
		$T_j = 125 \text{ }^\circ\text{C}$		0,9	1,1		V
r_F		$T_j = 25 \text{ }^\circ\text{C}$		4	4		V
		$T_j = 125 \text{ }^\circ\text{C}$		5,3	5,3		V
I_{RRM}	$I_F = 150 \text{ A}$	$T_j = 125 \text{ }^\circ\text{C}$		195			A
Q_{rr}	$di/dt = 3700 \text{ A}/\mu\text{s}$			52			μC
E_{rr}	$V_{GE} = -15 \text{ V}; V_{CC} = 1200 \text{ V}$			31			mJ
$R_{th(j-c)FD}$	per diode				0,25		K/W
Module							
L_{CE}				15	20		nH
$R_{CC'+EE'}$	res., terminal-chip	$T_{case} = 25 \text{ }^\circ\text{C}$		0,35			mΩ
		$T_{case} = 125 \text{ }^\circ\text{C}$		0,5			mΩ
$R_{th(c-s)}$	per module				0,038		K/W
M_s	to heat sink M6			3	5		Nm
M_t	to terminals M6			2,5	5		Nm
w					325		g

This is an electrostatic discharge sensitive device (ESDS), international standard IEC 60747-1, Chapter IX.

* The specifications of our components may not be considered as an assurance of component characteristics. Components have to be tested for the respective application. Adjustments may be necessary. The use of SEMIKRON products in life support appliances and systems is subject to prior specification and written approval by SEMIKRON. We therefore strongly recommend prior consultation of our personal.

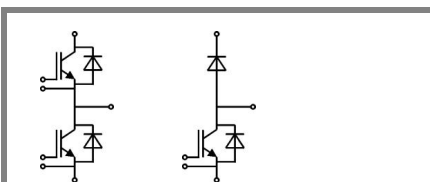

GB

GAL

SKM 200GB176D

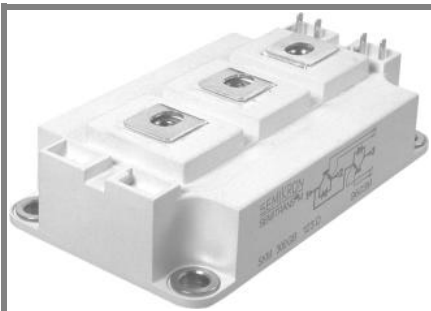

SEMITRANS® 3

Trench IGBT Modules

SKM 200GB176D

SKM 200GAL176D

Features

- Homogeneous Si
- Trench = Trenchgate technology
- V_{CEsat} with positive temperature coefficient
- High short circuit capability, self limiting to $6 \times I_c$

Typical Applications*

- AC inverter drives mains 575 - 750 V AC
- Public transport (auxiliary syst.)

Z_{th}		Conditions	Values	Units
Symbol				
$Z_{th(j-c)I}$				
$R_{\theta j-c}$	$i = 1$		80	mk/W
$R_{\theta j-c}$	$i = 2$		30	mk/W
$R_{\theta j-c}$	$i = 3$		8,2	mk/W
$R_{\theta j-c}$	$i = 4$		1,8	mk/W
$\tau_{th(j-c)I}$	$i = 1$		0,0753	s
$\tau_{th(j-c)I}$	$i = 2$		0,01	s
$\tau_{th(j-c)I}$	$i = 3$		0,0008	s
$\tau_{th(j-c)I}$	$i = 4$		0,0003	s
Symbol				
$Z_{th(j-c)D}$				
$R_{\theta j-c}$	$i = 1$		160	mk/W
$R_{\theta j-c}$	$i = 2$		67	mk/W
$R_{\theta j-c}$	$i = 3$		20	mk/W
$R_{\theta j-c}$	$i = 4$		3	mk/W
$\tau_{th(j-c)D}$	$i = 1$		0,0382	s
$\tau_{th(j-c)D}$	$i = 2$		0,009	s
$\tau_{th(j-c)D}$	$i = 3$		0,0009	s
$\tau_{th(j-c)D}$	$i = 4$		0,005	s

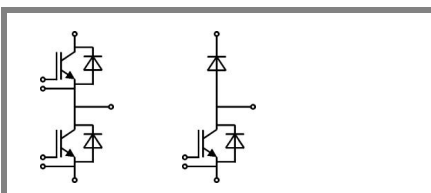

GB

GAL

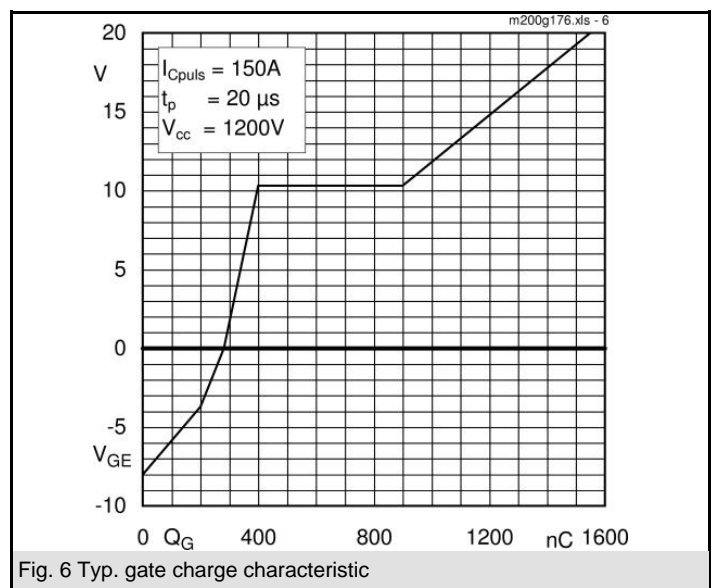
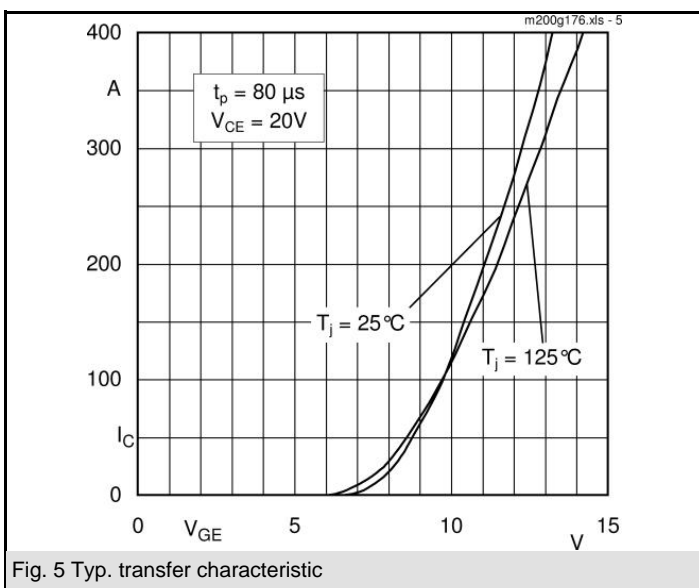
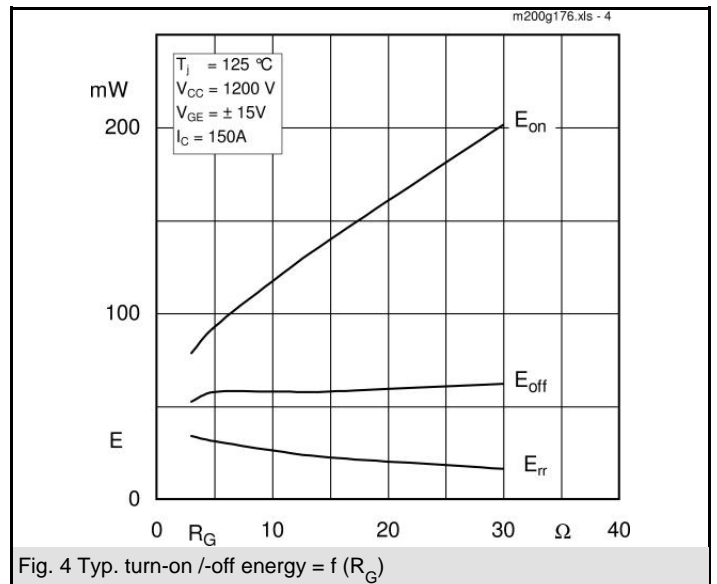
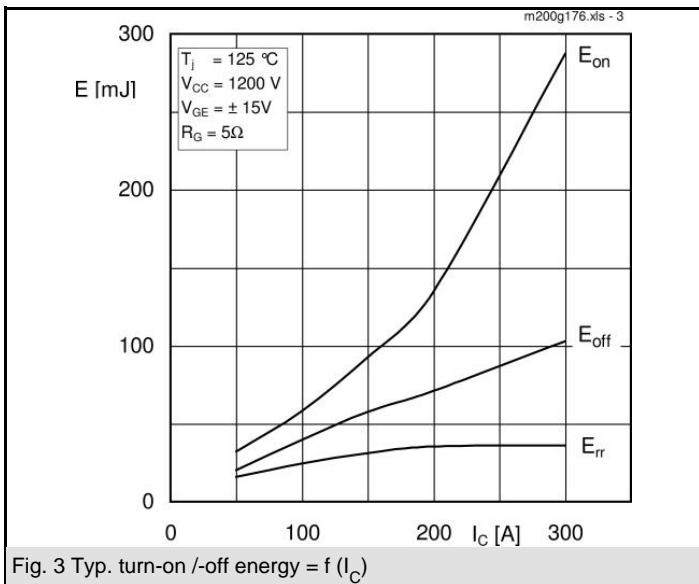
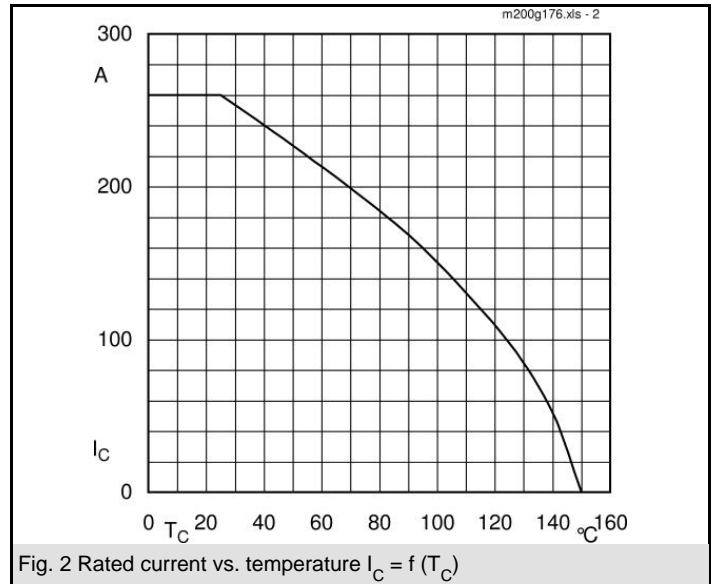
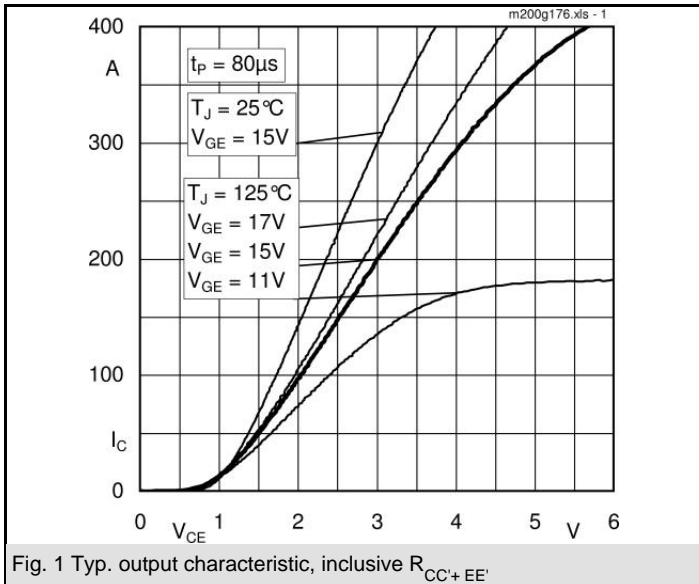

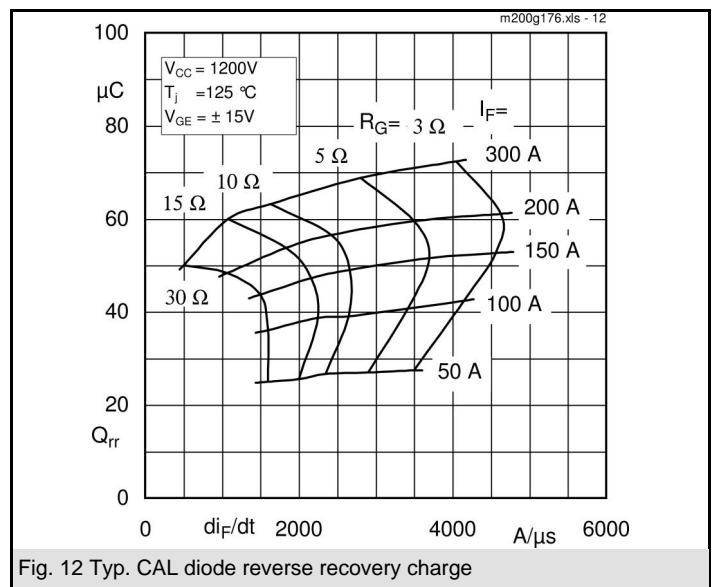
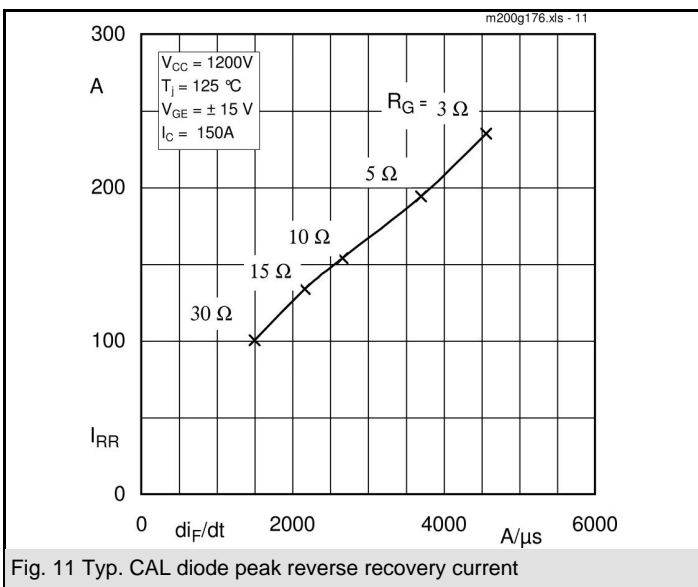
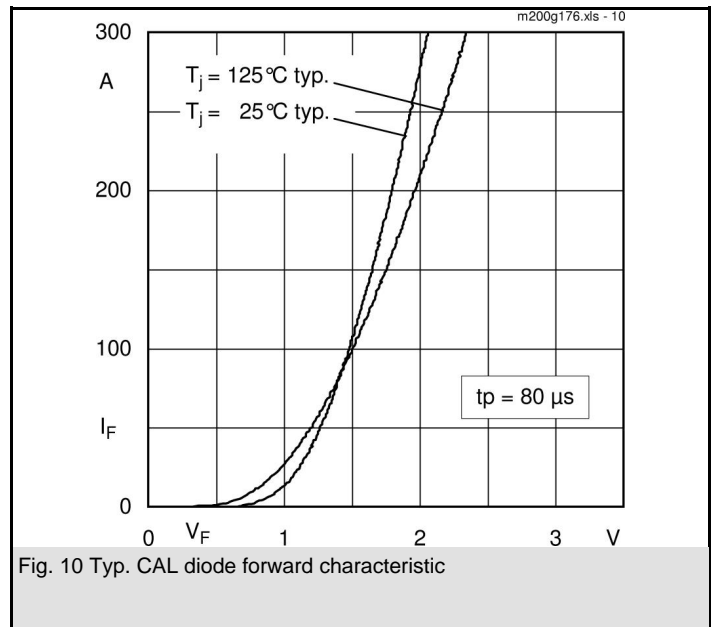
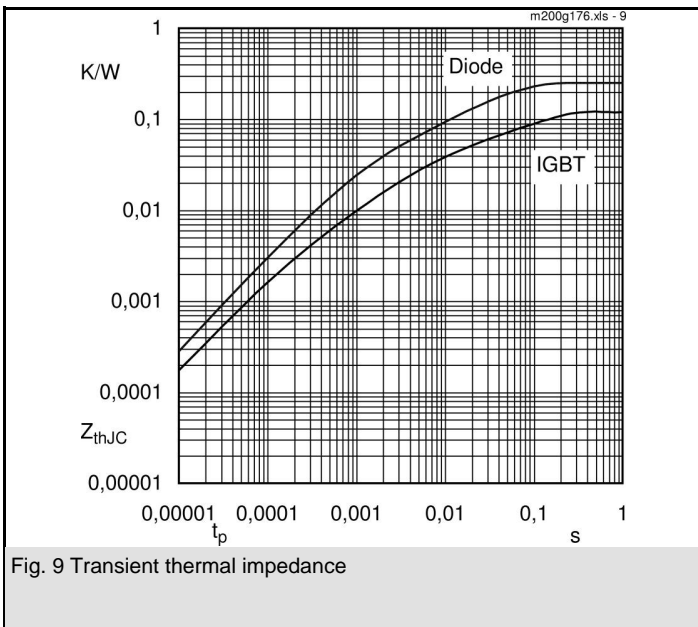
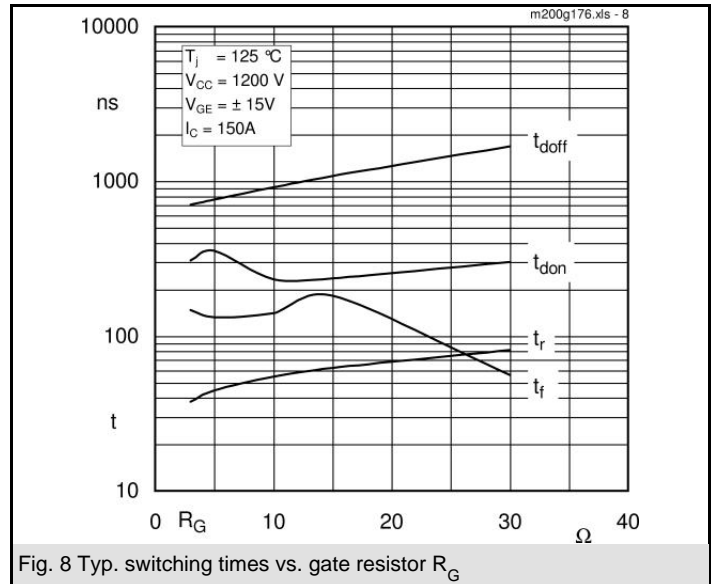
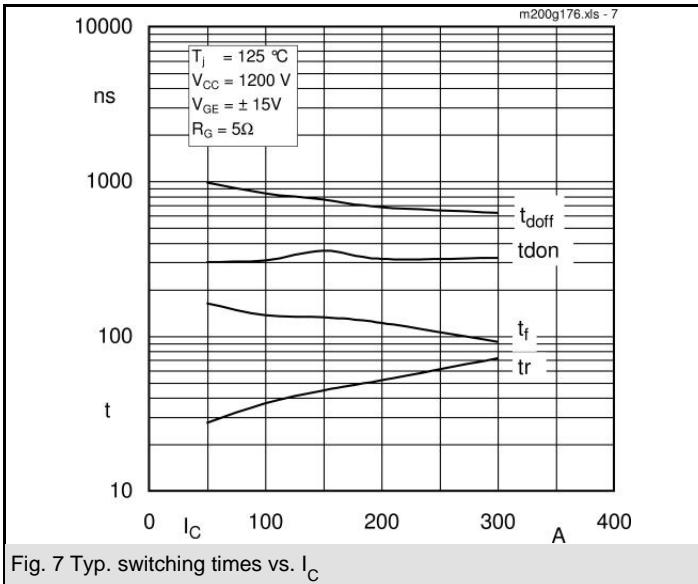

SKM 200GB176D

UL Recognized

CASED56

File no. E 63 532

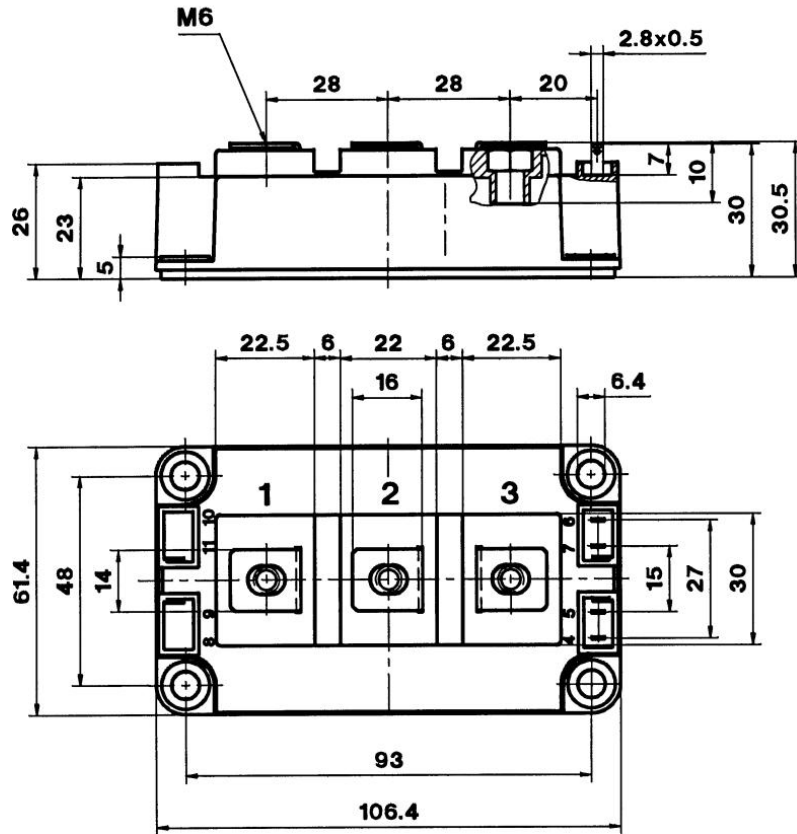

Case D 56

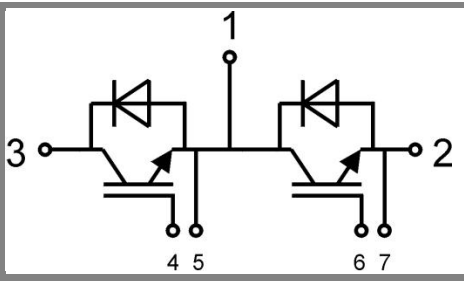

GB Case D 56

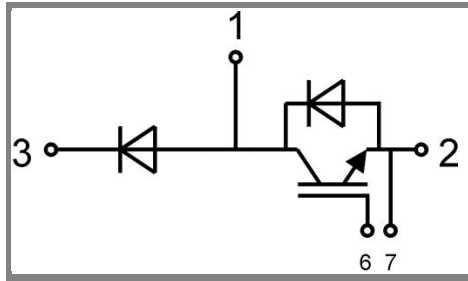

GAL Case D 57