

"Low Side Chopper" IGBT SOT-227 (Warp 2 Speed IGBT), 70 A

SOT-227
FEATURES

- NPT warp 2 speed IGBT technology with positive temperature coefficient
- Square RBSOA
- Low $V_{CE(on)}$
- FRED Pt[®] hyperfast rectifier
- Fully isolated package
- Very low internal inductance (≤ 5 nH typical)
- Industry standard outline
- UL approved file E78996 
- Compliant to RoHS directive 2002/95/EC

**RoHS
COMPLIANT**

PRODUCT SUMMARY	
V_{CES}	600 V
I_C DC	70 A at 88 °C
$V_{CE(on)}$ typical at 70 A, 25 °C	2.4 V
I_F DC	70 A at 86 °C

BENEFITS

- Designed for increased operating efficiency in power conversion: UPS, SMPS, welding, induction heating
- Easy to assemble and parallel
- Direct mounting to heatsink
- Plug-in compatible with other SOT-227 packages
- Higher switching frequency up to 150 kHz
- Lower conduction losses and switching losses
- Low EMI, requires less snubbing

ABSOLUTE MAXIMUM RATINGS				
PARAMETER	SYMBOL	TEST CONDITIONS	MAX.	UNITS
Collector to emitter voltage	V_{CES}		600	V
Continuous collector current	I_C	$T_C = 25$ °C	111	A
		$T_C = 80$ °C	76	
Pulsed collector current	I_{CM}		120	
Clamped inductive load current	I_{LM}		120	
Diode continuous forward current	I_F	$T_C = 25$ °C	113	
		$T_C = 80$ °C	75	
Peak diode forward current	I_{FM}		200	
Gate to emitter voltage	V_{GE}		± 20	V
Power dissipation, IGBT	P_D	$T_C = 25$ °C	447	W
		$T_C = 80$ °C	250	
Power dissipation, diode	P_D	$T_C = 25$ °C	236	
		$T_C = 80$ °C	132	
RMS isolation voltage	V_{ISOL}	Any terminal to case, $t = 1$ min	2500	V

ELECTRICAL SPECIFICATIONS (T _J = 25 °C unless otherwise specified)						
PARAMETER	SYMBOL	TEST CONDITIONS	MIN.	TYP.	MAX.	UNITS
Collector to emitter breakdown voltage	V _{BR(CES)}	V _{GE} = 0 V, I _C = 1 mA	600	-	-	
Collector to emitter voltage	V _{CE(on)}	V _{GE} = 15 V, I _C = 35 A	-	1.69	1.88	V
		V _{GE} = 15 V, I _C = 70 A	-	2.23	2.44	
		V _{GE} = 15 V, I _C = 35 A, T _J = 125 °C	-	2.07	2.31	
		V _{GE} = 15 V, I _C = 70 A, T _J = 125 °C	-	2.89	3.21	
Gate threshold voltage	V _{GE(th)}	V _{CE} = V _{GE} , I _C = 500 μA	3	3.9	5	
Temperature coefficient of threshold voltage	ΔV _{GE(th)} /ΔT _J	V _{CE} = V _{GE} , I _C = 1 mA (25 °C to 125 °C)	-	- 9	-	mV/°C
Collector to emitter leakage current	I _{CES}	V _{GE} = 0 V, V _{CE} = 600 V	-	1	100	μA
		V _{GE} = 0 V, V _{CE} = 600 V, T _J = 125 °C	-	0.07	2.0	mA
Diode reverse breakdown voltage	V _{BR}	I _R = 1 mA	600	-	-	V
Diode forward voltage drop	V _{FM}	I _C = 35 A, V _{GE} = 0 V	-	1.8	2.33	V
		I _C = 70 A, V _{GE} = 0 V	-	2.13	2.71	
		I _C = 35 A, V _{GE} = 0 V, T _J = 125 °C	-	1.35	1.81	
		I _C = 70 A, V _{GE} = 0 V, T _J = 125 °C	-	1.7	2.32	
Diode reverse leakage current	I _{RM}	V _R = V _R rated	-	0.1	50	μA
		T _J = 125 °C, V _R = V _R rated	-	0.01	3	mA
Gate to emitter leakage current	I _{GES}	V _{GE} = ± 20 V	-	-	± 200	nA

SWITCHING CHARACTERISTICS (T _J = 25 °C unless otherwise specified)							
PARAMETER	SYMBOL	TEST CONDITIONS	MIN.	TYP.	MAX.	UNITS	
Total gate charge (turn-on)	Q _g	I _C = 50 A, V _{CC} = 400 V, V _{GE} = 15 V	-	320	-	nC	
Gate to emitter charge (turn-on)	Q _{ge}		-	42	-		
Gate to collector charge (turn-on)	Q _{gc}		-	110	-		
Turn-on switching loss	E _{on}	I _C = 70 A, V _{CC} = 360 V, V _{GE} = 15 V, R _g = 5 Ω, L = 500 μH, T _J = 25 °C	-	1.15	-	mJ	
Turn-off switching loss	E _{off}		-	1.16	-		
Total switching loss	E _{tot}		-	2.31	-		
Turn-on switching loss	E _{on}		Energy losses include tail and diode recovery (see fig. 18)	-	1.27		-
Turn-off switching loss	E _{off}			-	1.28		-
Total switching loss	E _{tot}			-	2.55		-
Turn-on delay time	t _{d(on)}		I _C = 70 A, V _{CC} = 360 V, V _{GE} = 15 V, R _g = 5 Ω, L = 500 μH, T _J = 125 °C	-	208	-	ns
Rise time	t _r			-	69	-	
Turn-off delay time	t _{d(off)}			-	208	-	
Fall time	t _f	-		100	-		
Reverse bias safe operating area	RBSOA	T _J = 150 °C, I _C = 120 A, R _g = 22 Ω, V _{GE} = 15 V to 0 V, V _{CC} = 400 V, V _P = 600 V	Fullsquare				
Diode reverse recovery time	t _{rr}	I _F = 50 A, di _F /dt = 200 A/μs, V _R = 200 V	-	59	93	ns	
Diode peak reverse current	I _{rr}		-	4	6	A	
Diode recovery charge	Q _{rr}		-	118	279	nC	
Diode reverse recovery time	t _{rr}	I _F = 50 A, di _F /dt = 200 A/μs, V _R = 200 V, T _J = 125 °C	-	130	159	ns	
Diode peak reverse current	I _{rr}		-	11	13	A	
Diode recovery charge	Q _{rr}		-	715	995	nC	



THERMAL AND MECHANICAL SPECIFICATIONS					
PARAMETER	SYMBOL	MIN.	TYP.	MAX.	UNITS
Maximum junction and storage temperature range	T_J, T_{Stg}	- 40	-	150	$^{\circ}C$
Thermal resistance, junction to case	IGBT	-	-	0.28	$^{\circ}C/W$
	Diode	-	-	0.53	
Thermal resistance, case to sink per module	R_{thCS}	-	0.05	-	
Mounting torque, 6-32 or M3 screw		-	-	1.3	Nm
Weight		-	30	-	g

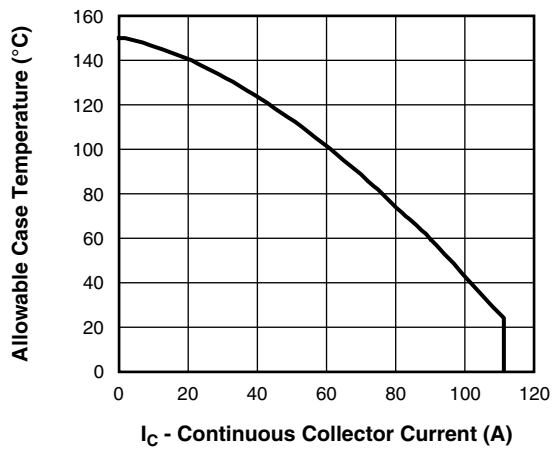

Fig. 1 - Maximum DC IGBT Collector Current vs. Case Temperature

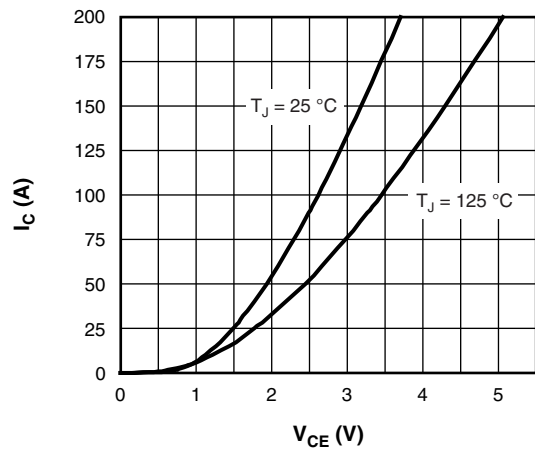

Fig. 3 - Typical IGBT Collector Current Characteristics

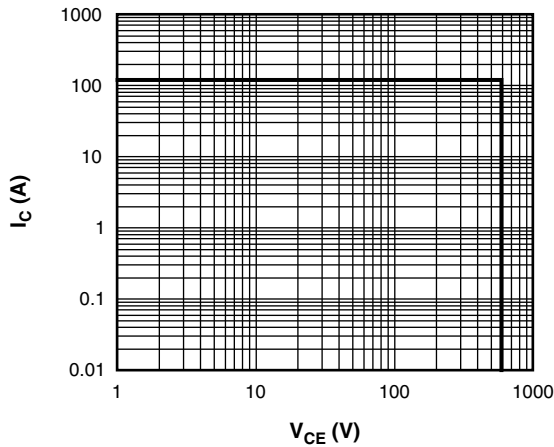

Fig. 2 - IGBT Reverse Bias SOA
 $T_J = 150^{\circ}C, V_{GE} = 15 V$

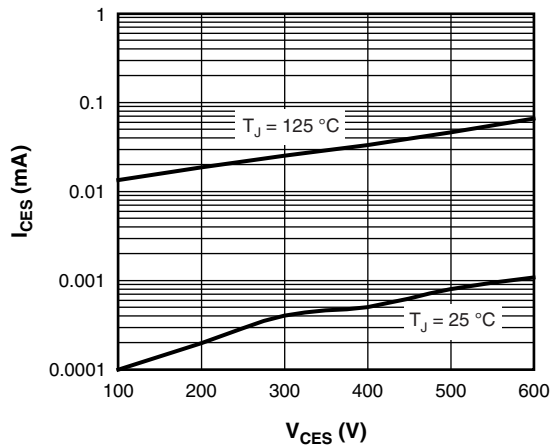

Fig. 4 - Typical IGBT Zero Gate Voltage Collector Current

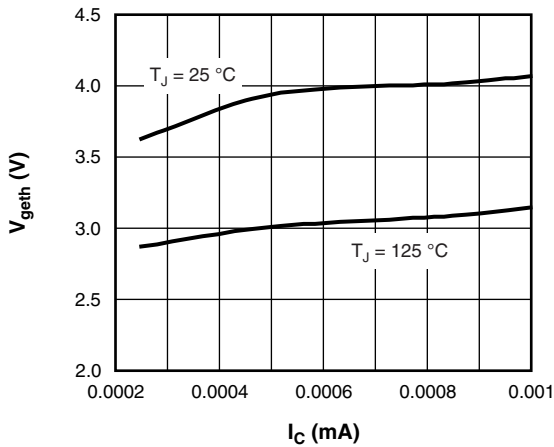

Fig. 5 - Typical IGBT Threshold Voltage

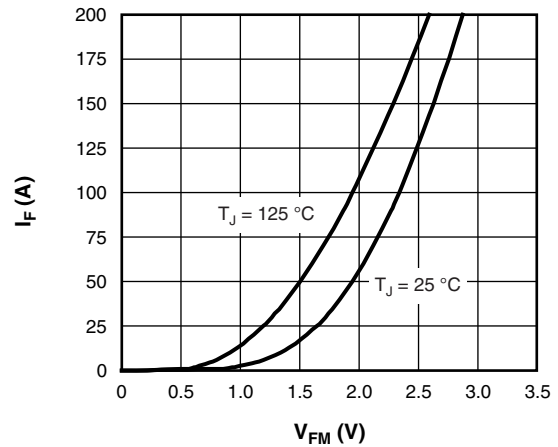

Fig. 8 - Typical Diode Forward Characteristics

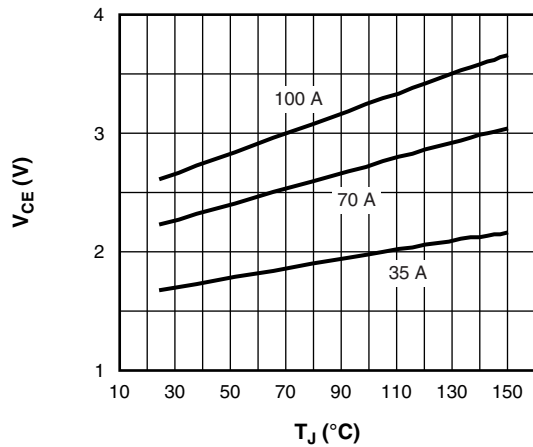

Fig. 6 - Typical IGBT Collector to Emitter Voltage vs. Junction Temperature, $V_{GE} = 15\text{ V}$

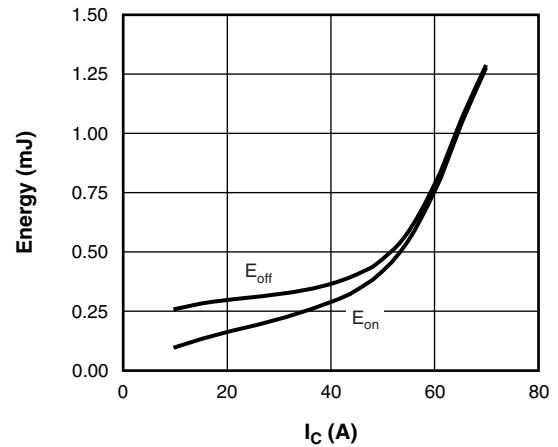

Fig. 9 - Typical IGBT Energy Loss vs. I_C
 $T_J = 125\text{ °C}$, $L = 500\text{ }\mu\text{H}$, $V_{CC} = 360\text{ V}$,
 $R_g = 5\text{ }\Omega$, $V_{GE} = 15\text{ V}$

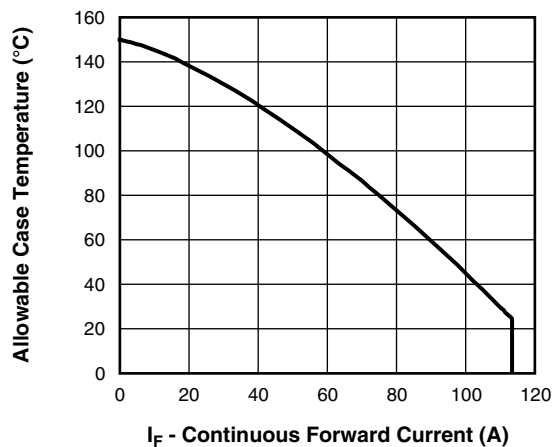

Fig. 7 - Maximum DC Forward Current vs. Case Temperature

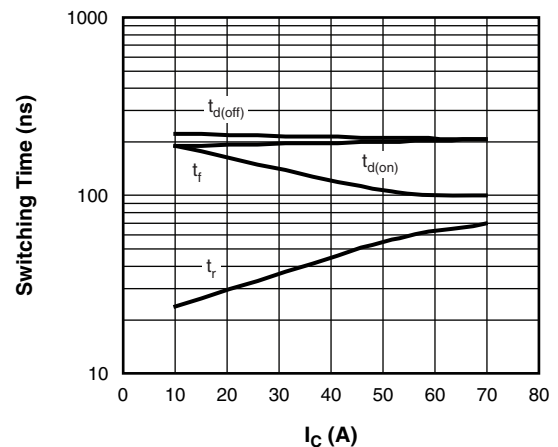
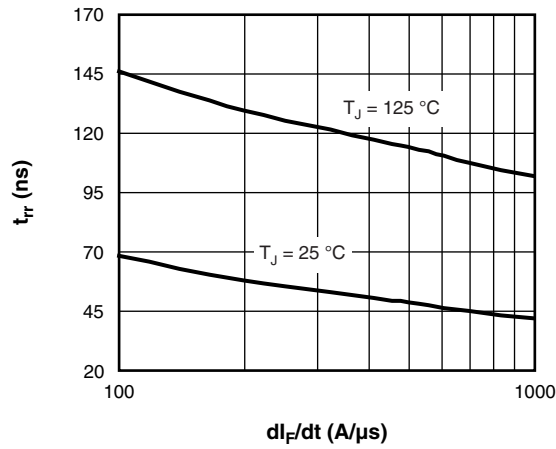
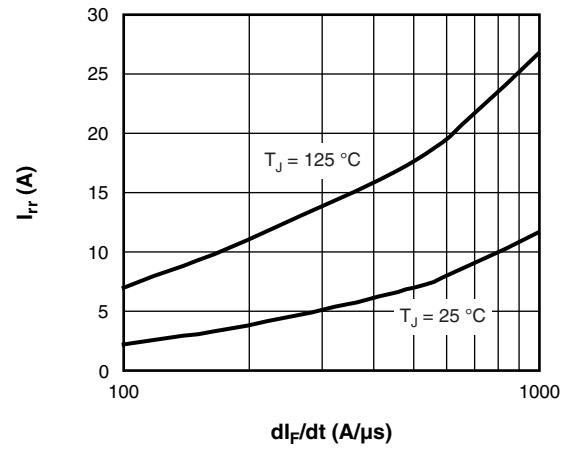
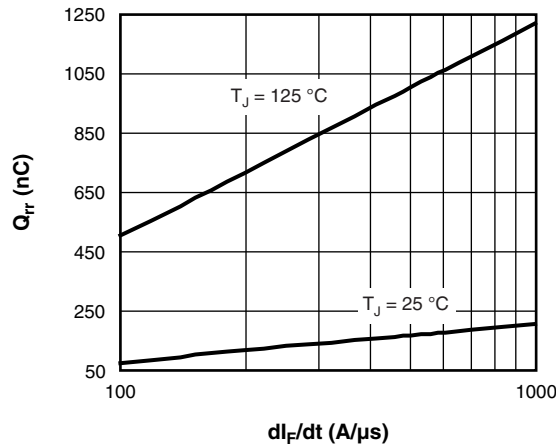
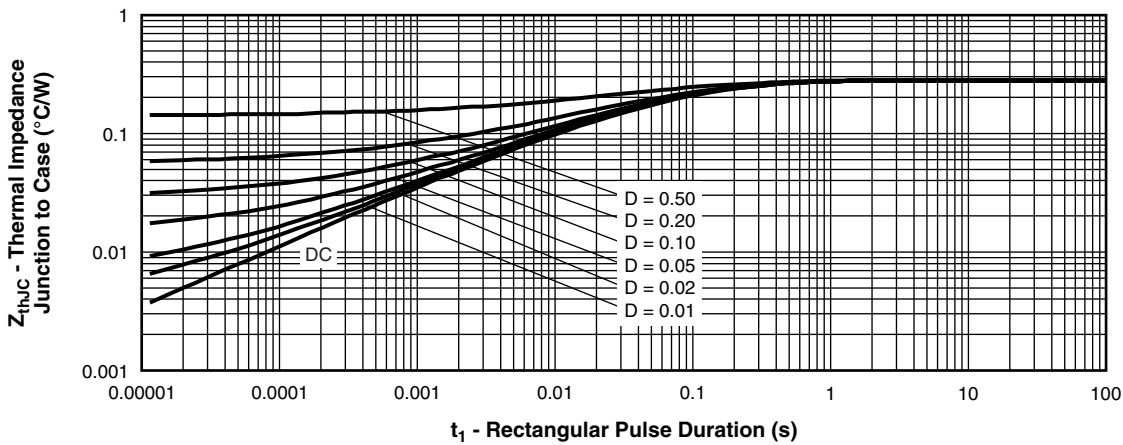

Fig. 10 - Typical IGBT Switching Time vs. I_C
 $T_J = 125\text{ °C}$, $L = 500\text{ }\mu\text{H}$, $V_{CC} = 360\text{ V}$,
 $R_g = 5\text{ }\Omega$, $V_{GE} = 15\text{ V}$

 Fig. 11 - Typical t_{rr} Diode vs. dl_F/dt
 $V_R = 200\text{ V}$, $I_F = 50\text{ A}$

 Fig. 12 - Typical I_{rr} Diode vs. dl_F/dt
 $V_{RR} = 200\text{ V}$, $I_F = 50\text{ A}$

 Fig. 13 - Typical Q_{rr} Diode vs. dl_F/dt
 $V_R = 200\text{ V}$, $I_F = 50\text{ A}$

 Fig. 14 - Maximum Thermal Impedance Z_{thJC} Characteristics (IGBT)

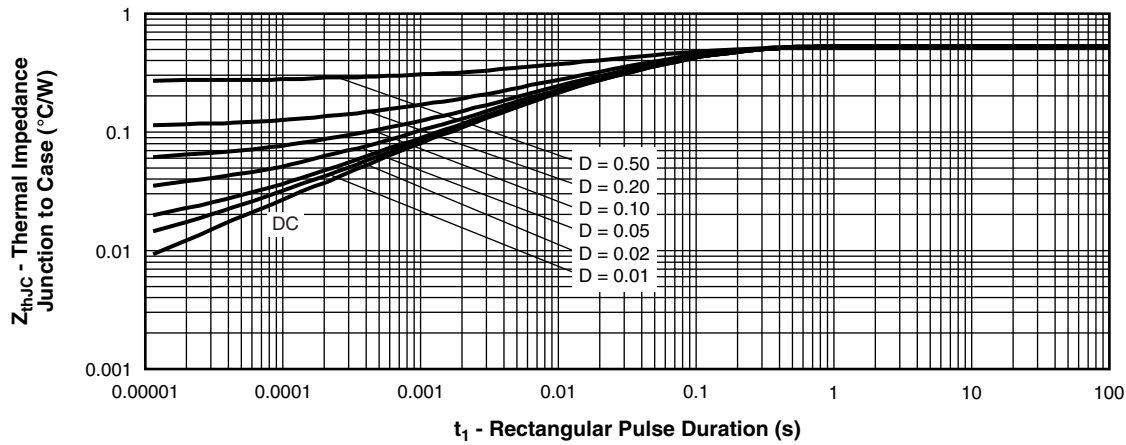

Fig. 15 - Maximum Thermal Impedance Z_{thJC} Characteristics (DIODE)

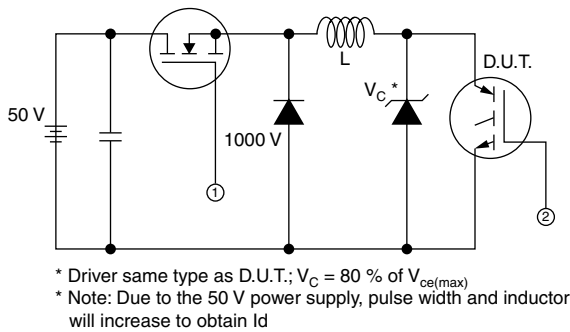

Fig. 16a - Clamped Inductive Load Test Circuit

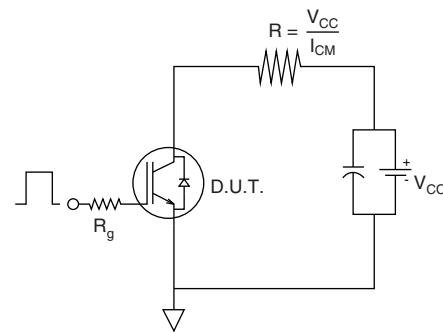

Fig. 16b - Pulsed Collector Current Test Circuit

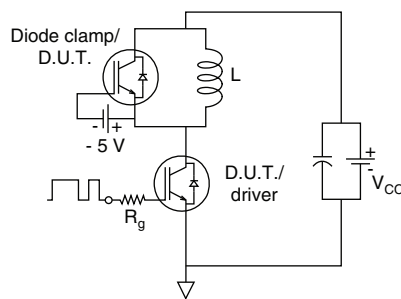

Fig. 17a - Switching Loss Test Circuit

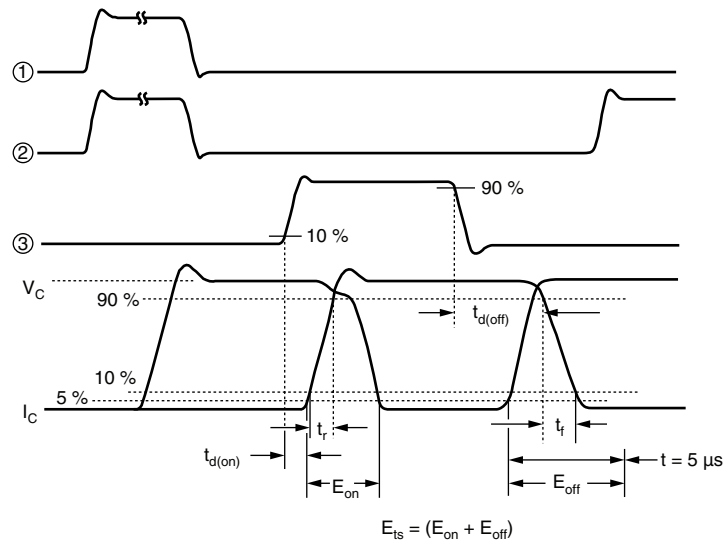

Fig. 17b - Switching Loss Waveforms Test Circuit

ORDERING INFORMATION TABLE

Device code	G	B	70	L	A	60	U	F	
	①	②	③	④	⑤	⑥	⑦	⑧	
	1	-	Insulated Gate Bipolar Transistor (IGBT)	2	-	B = IGBT Generation 5	3	-	Current rating (70 = 70 A)
	4	-	Circuit configuration (L = Low Side Chopper)	5	-	Package indicator (A = SOT-227)	6	-	Voltage rating (60 = 600 V)
	7	-	Speed/type (U = Ultrafast IGBT)	8	-	F = F/W FRED Pt [®] diode			

GB70LA60UF

Vishay Semiconductors "Low Side Chopper" IGBT SOT-227
(Warp 2 Speed IGBT), 70 A



CIRCUIT CONFIGURATION

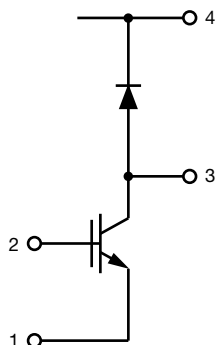

LINKS TO RELATED DOCUMENTS

LINKS TO RELATED DOCUMENTS	
Dimensions	http://www.vishay.com/doc?95036
Packaging information	http://www.vishay.com/doc?95037

SOT-227

DIMENSIONS in millimeters (inches)

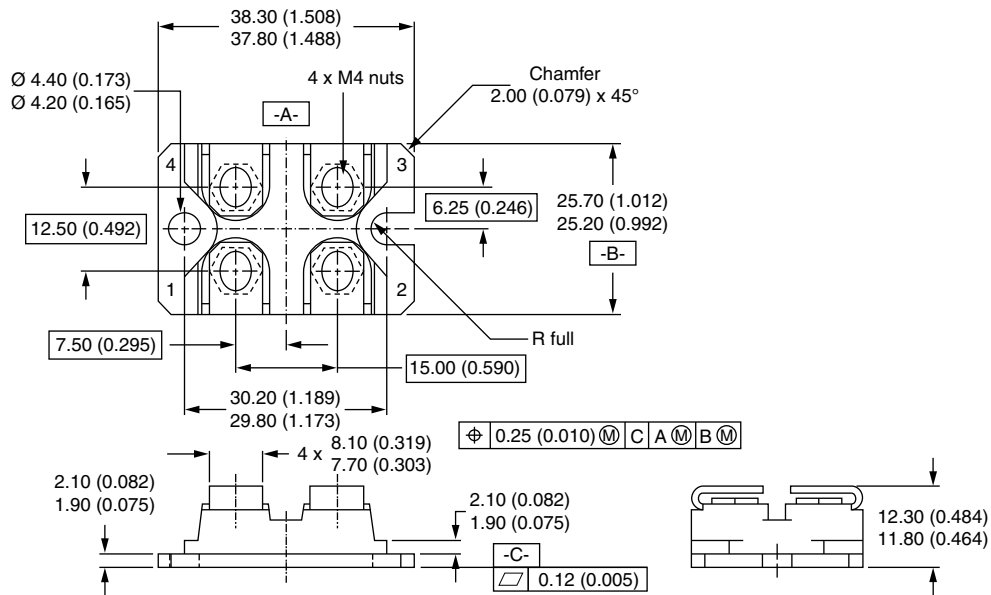

Notes

- Dimensioning and tolerancing per ANSI Y14.5M-1982
- Controlling dimension: millimeter



Disclaimer

ALL PRODUCT, PRODUCT SPECIFICATIONS AND DATA ARE SUBJECT TO CHANGE WITHOUT NOTICE TO IMPROVE RELIABILITY, FUNCTION OR DESIGN OR OTHERWISE.

Vishay Intertechnology, Inc., its affiliates, agents, and employees, and all persons acting on its or their behalf (collectively, "Vishay"), disclaim any and all liability for any errors, inaccuracies or incompleteness contained in any datasheet or in any other disclosure relating to any product.

Vishay makes no warranty, representation or guarantee regarding the suitability of the products for any particular purpose or the continuing production of any product. To the maximum extent permitted by applicable law, Vishay disclaims (i) any and all liability arising out of the application or use of any product, (ii) any and all liability, including without limitation special, consequential or incidental damages, and (iii) any and all implied warranties, including warranties of fitness for particular purpose, non-infringement and merchantability.

Statements regarding the suitability of products for certain types of applications are based on Vishay's knowledge of typical requirements that are often placed on Vishay products in generic applications. Such statements are not binding statements about the suitability of products for a particular application. It is the customer's responsibility to validate that a particular product with the properties described in the product specification is suitable for use in a particular application. Parameters provided in datasheets and/or specifications may vary in different applications and performance may vary over time. All operating parameters, including typical parameters, must be validated for each customer application by the customer's technical experts. Product specifications do not expand or otherwise modify Vishay's terms and conditions of purchase, including but not limited to the warranty expressed therein.

Except as expressly indicated in writing, Vishay products are not designed for use in medical, life-saving, or life-sustaining applications or for any other application in which the failure of the Vishay product could result in personal injury or death. Customers using or selling Vishay products not expressly indicated for use in such applications do so at their own risk and agree to fully indemnify and hold Vishay and its distributors harmless from and against any and all claims, liabilities, expenses and damages arising or resulting in connection with such use or sale, including attorneys fees, even if such claim alleges that Vishay or its distributor was negligent regarding the design or manufacture of the part. Please contact authorized Vishay personnel to obtain written terms and conditions regarding products designed for such applications.

No license, express or implied, by estoppel or otherwise, to any intellectual property rights is granted by this document or by any conduct of Vishay. Product names and markings noted herein may be trademarks of their respective owners.