

MAX2870

23.5MHz to 6000MHz Fractional/ Integer-N Synthesizer/VCO

General Description

The MAX2870 is an ultra-wideband phase-locked loop (PLL) with integrated voltage control oscillators (VCOs) capable of operating in both integer-N and fractional-N modes. When combined with an external reference oscillator and loop filter, the MAX2870 is a high-performance frequency synthesizer capable of synthesizing frequencies from 23.5MHz to 6.0GHz while maintaining superior phase noise and spurious performance.

The ultra-wide frequency range is achieved with the help of multiple integrated VCOs covering 3000MHz to 6000MHz, and output dividers ranging from 1 to 128. The device also provides dual differential output drivers, which can be independently programmable to deliver -4dBm to +5dBm output power. Both outputs can be muted by either software or hardware control.

The MAX2870 is controlled by a 3-wire serial interface and is compatible with 1.8V control logic. The device is available in a lead-free, RoHS-compliant, 5mm x 5mm, 32-pin TQFN package, and operates over an extended -40°C to +85°C temperature range.

Applications

| | |
|--------------------------|------------------------|
| Wireless Infrastructure | Military and Aerospace |
| Test and Measurement | PMAR/LMAR/Public |
| Satellite Communications | Safety Radio |
| Wireless LANs/CATV | Clock Generation |

Benefits and Features

- ◆ Integer and Fractional-N Modes
- ◆ Manual or Automatic VCO Selection
- ◆ 3000MHz to 6000MHz Fundamental VCO
- ◆ Output Binary Buffers/Dividers for Extended Frequency Range
 - ◇ 1/2/4/8/16/32/64/128
 - ◇ 23.5MHz to 6000MHz
- ◆ High-Performance PFD
 - ◇ 105MHz in Integer-N Mode
 - ◇ 50MHz in Fractional-N Mode
- ◆ Reference Frequency Up to 200MHz
- ◆ Operates from +3.0V to +3.6V Supply
- ◆ Dual Programmable Outputs
 - ◇ -4dBm to +5dBm
- ◆ Analog and Digital Lock Detect Indicators
- ◆ Hardware and Software Shutdown Control
- ◆ Compatible with 1.8V Control Logic

Ordering Information appears at end of data sheet.

Typical Application Circuit appears at end of data sheet.

For related parts and recommended products to use with this part, refer to www.maxim-ic.com/MAX2870.related.

Functional Diagram

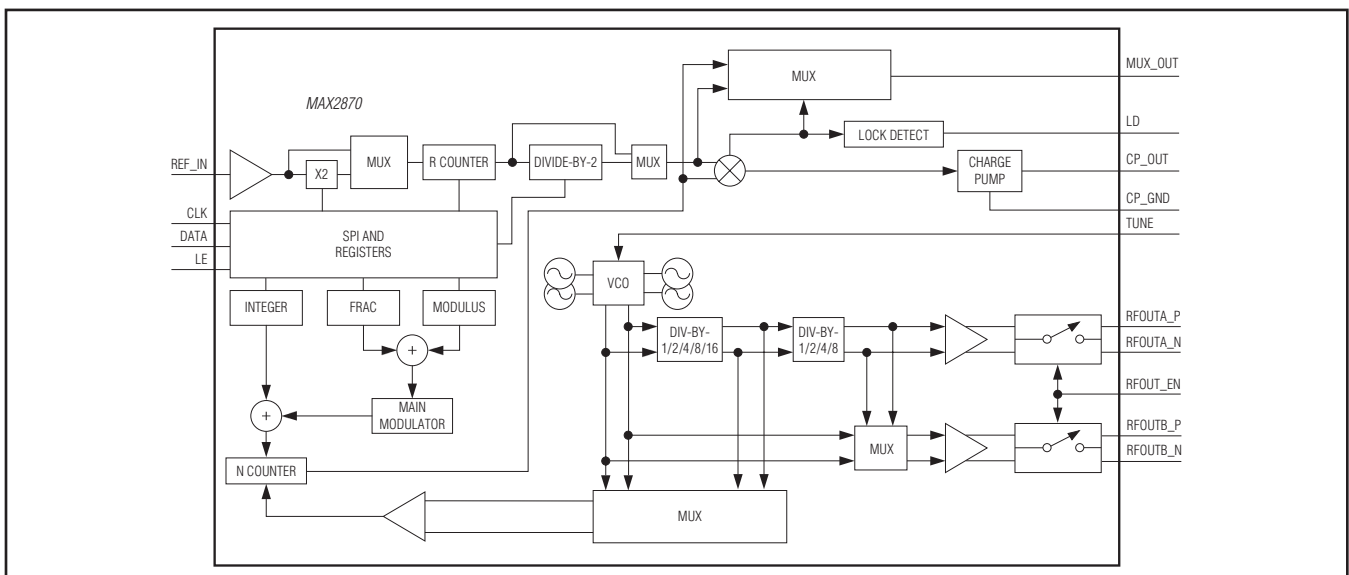

23.5MHz to 6000MHz Fractional/ Integer-N Synthesizer/VCO

ABSOLUTE MAXIMUM RATINGS

| | | | |
|---|----------------------------------|-----------------------------------|-----------------|
| V _{CC_} to GND_ | -0.3V to +3.9V | Junction Temperature | +150°C |
| All Other Pins to GND_ | -0.3V to V _{CC_} + 0.3V | Operating Temperature Range | -40°C to +85°C |
| Continuous Power Dissipation (T _A = +70°C) | | Storage Temperature Range | -65°C to +150°C |
| TQFN-EP Multilayer Board | | Lead Temperature (soldering, 10s) | +300°C |
| (derate 34.5mW/°C above +70°C) | 2758.6mW | Soldering temperature (reflow) | +260°C |

Stresses beyond those listed under "Absolute Maximum Ratings" may cause permanent damage to the device. These are stress ratings only, and functional operation of the device at these or any other conditions beyond those indicated in the operational sections of the specifications is not implied. Exposure to absolute maximum rating conditions for extended periods may affect device reliability.

PACKAGE THERMAL CHARACTERISTICS (Note 1)

| | | | |
|---|--------|--|---------|
| TQFN | | | |
| Junction-to-Ambient Thermal Resistance (θ _{JA}) | 29°C/W | Junction-to-Case Thermal Resistance (θ _{JC}) | 1.7°C/W |

Note 1: Package thermal resistances were obtained using the method described in JEDEC specification JESD51-7, using a four-layer board. For detailed information on package thermal considerations, refer to www.maxim-ic.com/thermal-tutorial.

DC ELECTRICAL CHARACTERISTICS

(Measured using MAX2870 EV Kit. V_{CC_} = 3V to 3.6V, V_{GND_} = 0V, f_{REF_IN} = 50MHz, f_{PFD} = 25MHz, T_A = -40°C to +85°C. Typical values measured at V_{CC_} = 3.3V; T_A = +25°C; register settings 00780000,20000141,01005E42,00000013,610F423C,01400005; unless otherwise noted.) (Note 2)

| PARAMETER | CONDITIONS | | MIN | TYP | MAX | UNITS |
|----------------------------|--|---|-----|-----|-----|-------|
| Supply Voltage | | | 3 | 3.3 | 3.6 | V |
| RFOUT_ Current Consumption | I _{RFOUT_} , minimum output power, single channel | | 8.5 | | | mA |
| | I _{RFOUT_} , maximum output power, single channel | | 25 | 29 | | |
| Supply Current | Both channels enabled, maximum output power | Total, including RFOUT, both channel (Note 3) | 144 | 180 | | mA |
| | | Each output divide-by-2 | 10 | 15 | | |
| | | I _{CCVCO} + I _{CCRF} (Note 3) | 75 | 95 | | |
| | | Low-power sleep mode | | | 1 | |

AC ELECTRICAL CHARACTERISTICS

(Measured using MAX2870 EV Kit. V_{CC_} = 3V to 3.6V, V_{GND_} = 0V, f_{REF_IN} = 50MHz, f_{PFD} = 25MHz, f_{RFOUT_} = 6000MHz, T_A = -40°C to +85°C. Typical values measured at V_{CC_} = 3.3V, T_A = +25°C, register settings 00780000,20000141,01005E42,00000013,610F423C,01400005; unless otherwise noted.) (Note 2)

| PARAMETER | CONDITIONS | MIN | TYP | MAX | UNITS |
|--|-------------------|-----|-----|------------------|-----------------|
| REFERENCE OSCILLATOR INPUT (REF_IN) | | | | | |
| REF_IN Input Frequency Range | | 10 | | 200 | MHz |
| REF_IN Input Sensitivity | | 0.7 | | V _{CC_} | V _{PP} |
| REF_IN Input Capacitance | | | 2 | | pF |
| REF_IN Input Current | | -60 | | +60 | μA |
| PHASE DETECTOR | | | | | |
| Phase Detector Frequency | Integer-N mode | | | 105 | MHz |
| | Fractional-N mode | | | 50 | |

23.5MHz to 6000MHz Fractional/ Integer-N Synthesizer/VCO

AC ELECTRICAL CHARACTERISTICS (continued)

(Measured using MAX2870 EV Kit. $V_{CC_} = 3V$ to $3.6V$, $V_{GND_} = 0V$, $f_{REF_IN} = 50MHz$, $f_{PFD} = 25MHz$, $f_{RFOUT_} = 6000MHz$, $T_A = -40^{\circ}C$ to $+85^{\circ}C$. Typical values measured at $V_{CC_} = 3.3V$, $T_A = +25^{\circ}C$, register settings 00780000,20000141,01005E42,0000013,610F423C,01400005; unless otherwise noted.) (Note 2)

| PARAMETER | CONDITIONS | MIN | TYP | MAX | UNITS |
|--|---|---------------|------|--------|-----------|
| CHARGE PUMP | | | | | |
| Sink/Source Current | CP[3:0] = 1111, $R_{SET} = 5.1k\Omega$ | | 5.12 | | mA |
| | CP[3:0] = 0000, $R_{SET} = 5.1k\Omega$ | | 0.32 | | |
| R_{SET} Range | | 2.7 | | 10 | $k\Omega$ |
| RF OUTPUTS | | | | | |
| Fundamental Frequency Range | | 3000 | | 6000 | MHz |
| Divided Frequency Range | With output dividers (1/2/4/8/16/32/64/128) | 23.4375 | | 6000 | MHz |
| VCO Sensitivity | | | 100 | | MHz/V |
| Frequency Pushing | Open loop | | 0.7 | | MHz/V |
| Frequency Pulling | Open loop into 2:1 VSWR | | 70 | | KHz |
| 2nd Harmonic | Fundamental VCO output | | 40 | | dBc |
| 3rd Harmonic | Fundamental VCO output | | 34 | | dBc |
| 2nd Harmonic | VCO output divided-by-2 | | 20 | | dBc |
| 3rd Harmonic | VCO output divided-by-2 | | 21 | | dBc |
| Maximum Output Power | $f_{RFOUT_} = 3000MHz$ (Note 4) | | 5 | | dBm |
| Minimum Output Power | $f_{RFOUT_} = 3000MHz$ (Note 4) | | -4 | | dBm |
| Output Power Variation (Note 4) | $-40^{\circ}C \leq T_A \leq +85^{\circ}C$ | | 1.5 | | dB |
| | $3V \leq V_{CC_} \leq 3.6V$ | | 0.2 | | |
| Muted Output Power | (Note 4) | | -31 | | dBm |
| VCO AND FREQUENCY SYNTHESIZER NOISE | | | | | |
| VCO Phase Noise (Note 5) | VCO at 3000MHz | 10kHz offset | | -83.5 | dBc/Hz |
| | | 100kHz offset | | -111 | |
| | | 1MHz offset | | -136 | |
| | | 5MHz offset | | -149 | |
| | VCO at 4500MHz | 10kHz offset | | -75 | |
| | | 100kHz offset | | -104 | |
| | | 1MHz offset | | -130 | |
| | | 5MHz offset | | -145.5 | |
| | VCO at 6000MHz | 10kHz offset | | -71.5 | |
| | | 100kHz offset | | -100.5 | |
| | | 1MHz offset | | -128.0 | |
| | | 5MHz offset | | -143.5 | |
| In-Band Noise Floor | Normalized (Note 6) | | -223 | | dBc/Hz |
| 1/f Noise | Normalized (Note 7) | | -116 | | dBc/Hz |
| In-Band Phase Noise | (Note 8) | | -95 | | dBc/Hz |
| Integrated RMS Jitter | (Note 9) | | 0.45 | | ps |
| Spurious Signals Due to PFD Frequency | | | -87 | | dBc |
| VCO Tune Voltage | | 0.5 | | 2.5 | V |

23.5MHz to 6000MHz Fractional/ Integer-N Synthesizer/VCO

DIGITAL I/O CHARACTERISTICS

($V_{CC_}$ = +3V to +3.6V, $V_{GND_}$ = 0V, T_A = -40°C to +85°C. Typical values at $V_{CC_}$ = 3.3V, T_A = +25°C.) (Note 2)

| PARAMETER | CONDITIONS | MIN | TYP | MAX | UNITS |
|--|----------------------|------------------|-----|-----|---------|
| SERIAL INTERFACE INPUTS (CLK, DATA, LE, CE, RFOUT_EN) | | | | | |
| Input Logic-Level Low | | | | 0.6 | V |
| Input Logic-Level High | V_{OH} | 1.5 | | | V |
| Input Current | I_{IH}/I_{IL} | -1 | | +1 | μ A |
| Input Capacitance | | | 1 | | pF |
| SERIAL INTERFACE OUTPUTS (MUX_OUT, LD) | | | | | |
| Output Logic-Level Low | 0.3mA sink current | | | 0.4 | V |
| Output Logic-Level High | 0.3mA source current | $V_{CC_} - 0.4$ | | | V |
| Output Current Level High | | | | 0.5 | mA |

SPI TIMING CHARACTERISTICS

($V_{CC_}$ = +3V to +3.6V, $V_{GND_}$ = 0V, T_A = -40°C to +85°C. Typical values at $V_{CC_}$ = 3.3V, T_A = +25°C.) (Note 2)

| PARAMETER | SYMBOL | CONDITIONS | MIN | TYP | MAX | UNITS |
|-----------------------------|-----------|--|-----|-----|-----|-------|
| CLK Clock Period | t_{CP} | Guaranteed by SCL pulse-width low and high | 50 | | | ns |
| CLK Pulse-Width Low | t_{CL} | | 25 | | | ns |
| CLK Pulse-Width High | t_{CH} | | 25 | | | ns |
| LE Setup Time | t_{LES} | | 20 | | | ns |
| LE Hold Time | t_{LEH} | | 10 | | | ns |
| LE Minimum Pulse-Width High | t_{LEW} | | 20 | | | ns |
| Data Setup Time | t_{DS} | | 25 | | | ns |
| Data Hold Time | t_{DH} | | 25 | | | ns |
| MUX_OUT Setup Time | t_{MS} | | 10 | | | ns |
| MUX_OUT Hold Time | t_{MH} | | 10 | | | ns |

Note 2: Production tested at T_A = +25°C. Cold and hot are guaranteed by design and characterization.

Note 3: f_{REFIN} = 40MHz, phase detector frequency = 40MHz, RF output = 3000MHz.

Register setting: 00780000,20000141,01005E42,00000013,610F43FC,01400005

Note 4: Measured single ended with 27nH to V_{CC_RF} into 50 Ω load. Power measured with single output enabled. Unused output has 27nH to V_{CC_RF} with 50 Ω termination.

Note 5: VCO phase noise is measured open loop.

Note 6: Measured at 100kHz with 50MHz Connor-Winfield CWX813 TCXO with 500kHz loop bandwidth.

Register setting: 803A0000,8000FFF9,81005F42,F4000013,6384803C,001500005

Note 7: 1/f noise contribution to the in-band phase noise is computed by using $1/f_{noise} + 10\log(10\text{kHz}/f_{OFFSET}) + 20\log(f_{RF}/1\text{GHz})$. Register setting: 803A0000,8000FFF9,81005F42,F4000013,6384803C,001500005

Note 8: f_{REFIN} = 50MHz; f_{PFD} = 25MHz; offset frequency = 10kHz; VCO frequency = 4227MHz, output divide-by-2 enabled. RFOUT = 2113.5MHz; N = 169; loop BW = 40kHz, CP[3:0] = 1111; integer mode.

Note 9: f_{REFIN} = 50MHz; f_{PFD} = 25MHz; VCO frequency = 4400MHz, $f_{RFOUT_}$ = 4400MHz; N = 176; loop BW = 40kHz, CP[3:0] = 1111; integer mode.

23.5MHz to 6000MHz Fractional/ Integer-N Synthesizer/VCO

Typical Operating Characteristics

(Measured with MAX2870 EV Kit. $V_{CC_} = 3.3V$, $V_{GND_} = 0V$, $f_{REF_IN} = 50MHz$, $T_A = +25^\circ C$, see the Testing Conditions Table.)

3.0GHz VCO OPEN-LOOP PHASE NOISE vs. FREQUENCY

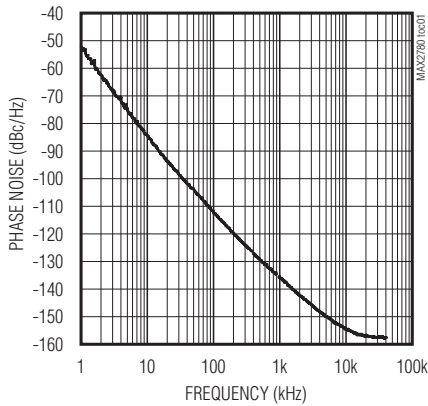

4.5GHz VCO OPEN-LOOP PHASE NOISE vs. FREQUENCY

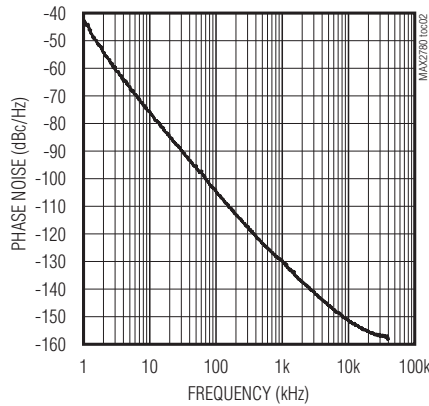

6.0GHz VCO OPEN-LOOP PHASE NOISE vs. FREQUENCY

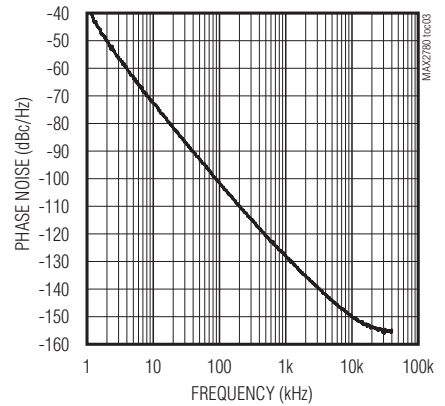

3.0GHz CLOSED-LOOP PHASE NOISE vs. FREQUENCY

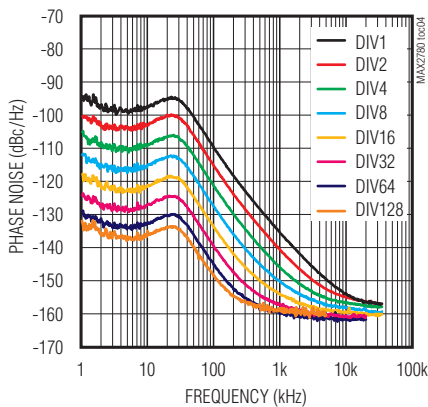

4.5GHz CLOSED-LOOP PHASE NOISE vs. FREQUENCY

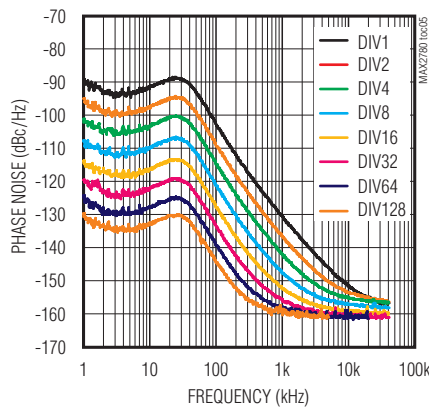

6.0GHz CLOSED-LOOP PHASE NOISE vs. FREQUENCY

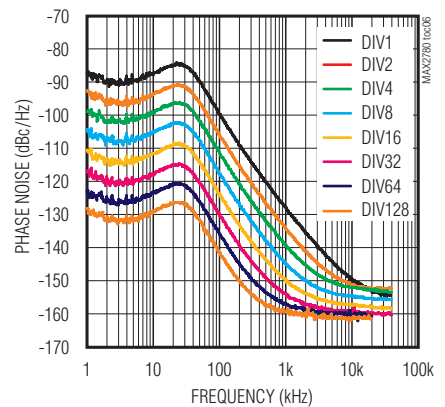

904MHz INTEGER-N MODE PHASE NOISE AND SPUR PERFORMANCE vs. FREQUENCY

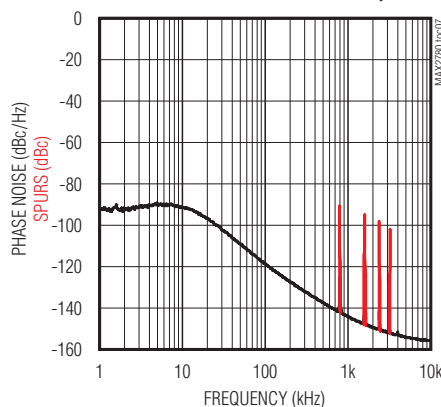

2687.5MHz INTEGER-N MODE PHASE NOISE AND SPUR PERFORMANCE vs. FREQUENCY

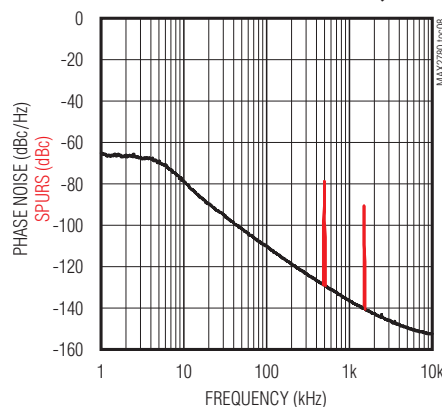

2113.5MHz FRACTIONAL-N PHASE NOISE (LOW-NOISE MODE) vs. FREQUENCY

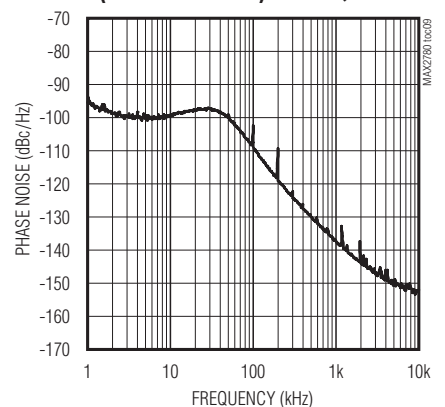

23.5MHz to 6000MHz Fractional/ Integer-N Synthesizer/VCO

Typical Operating Characteristics (continued)

(Measured with MAX2870 EV Kit. $V_{CC_} = 3.3V$, $V_{GND_} = 0V$, $f_{REF_IN} = 50MHz$, $T_A = +25^\circ C$, see the Testing Conditions Table.)

2113.5MHz FRACTIONAL-N PHASE NOISE vs. FREQUENCY (LOW-SPUR MODE)

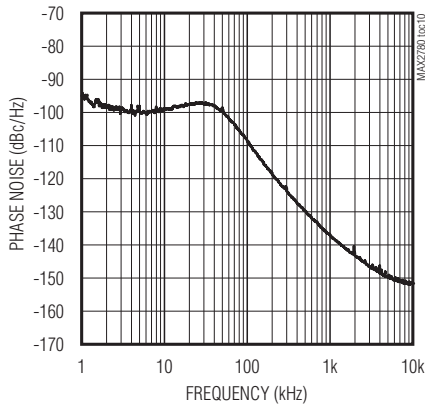

2679.4MHz FRACTIONAL-N PHASE NOISE vs. FREQUENCY (LOW-NOISE MODE)

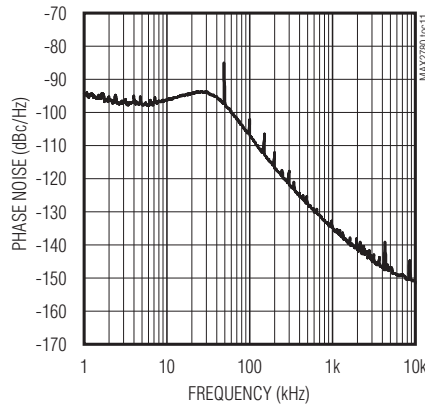

2679.4MHz FRACTIONAL-N PHASE NOISE vs. FREQUENCY (LOW-SPUR MODE)

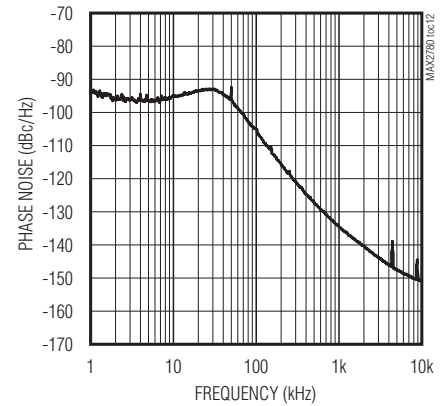

SUPPLY CURRENT vs. OUTPUT POWER SETTING (ONE CHANNEL ACTIVE, 3GHz)

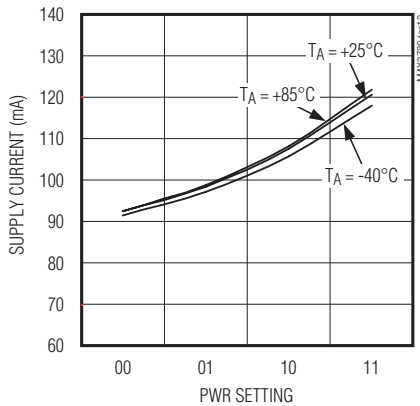

SUPPLY CURRENT vs. FREQUENCY (ONE CHANNEL ACTIVE, MAXIMUM OUTPUT POWER)

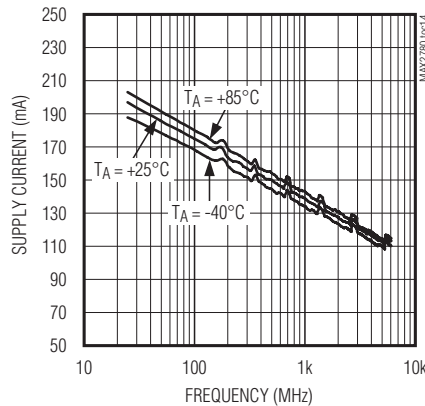

SUPPLY CURRENT vs. OUTPUT POWER SETTING (TWO CHANNELS ACTIVE)

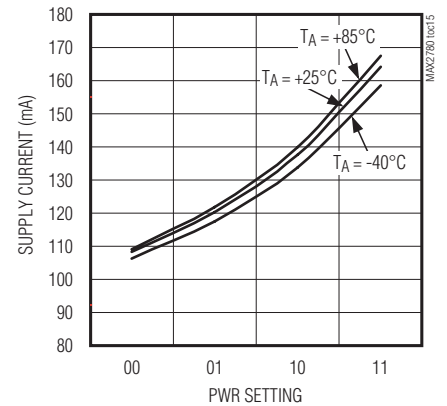

MAX2870

23.5MHz to 6000MHz Fractional/ Integer-N Synthesizer/VCO

Typical Operating Characteristics (continued)

(Measured with MAX2870 EV Kit. $V_{CC_} = 3.3V$, $V_{GND_} = 0V$, $f_{REF_IN} = 50MHz$, $T_A = +25^\circ C$, see the Testing Conditions Table.)

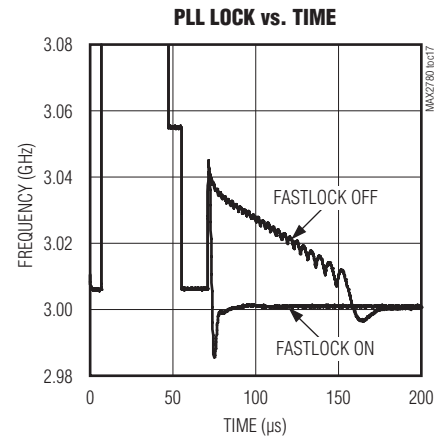
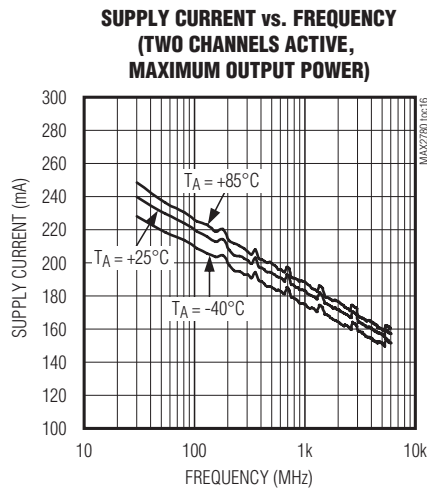

Typical Operating Characteristics Testing Conditions Table

| TOC TITLE | f_{REF} (MHz) | f_{PFD} (MHz) | REGISTER SETTINGS (hex) | LOOP FILTER BW (Hz) | MAX2870 EV KIT COMPONENT VALUES | | | | | COMMENTS |
|---|--------------------|--------------------|--|---------------------------|---------------------------------|-------------------------|------------|--------------------|------------|---|
| | | | | | C13 (F) | R1 + R2 (Ω) | C14 (F) | R0 (Ω) | C12 (F) | |
| 3.0GHz VCO OPEN-LOOP PHASE NOISE vs. FREQUENCY | N/A | N/A | 80B40000, 80000141, 0000405A, XX00013, 648020FC, 00000005 | | | | | | | VCO bits set for 3GHz output, VAS_SHDN = 1 |
| 4.5GHz VCO OPEN-LOOP PHASE NOISE vs. FREQUENCY | N/A | N/A | 80B40000, 80000141, 0000405A, XX00013, 648020FC, 00000005 | | | | | | | VCO bits set for 4.5GHz output, VAS_SHDN = 1 |
| 6.0GHz VCO OPEN-LOOP PHASE NOISE vs. FREQUENCY | N/A | N/A | 80B40000, 80000141, 0000405A, XX00013, 648020FC, 00000005 | | | | | | | VCO bits set for 6.0GHz output, VAS_SHDN = 1 |

23.5MHz to 6000MHz Fractional/ Integer-N Synthesizer/VCO

Typical Operating Characteristics Testing Conditions Table

| TOC TITLE | f _{REF} (MHz) | f _{PDF} (MHz) | REGISTER SETTINGS (hex) | TOC TITLE | MAX2870 EV KIT COMPONENT VALUES | | | | | COMMENTS |
|---|---------------------------|---------------------------|---|--------------|---------------------------------|----------------|------------|-----------|------------|----------|
| | | | | | C13 (F) | R1 + R2 (Ω) | C14 (F) | R0 (Ω) | C12 (F) | |
| 3.0GHz CLOSED-LOOP PHASE NOISE vs. FREQUENCY | 50 | 25 | 803C0000 80000141 00009E42, E8000013, 618160FC, 00400005 | 40k | 0.1μ | 120 | 0.012μ | 250 | 820p | |
| 4.5GHz CLOSED-LOOP PHASE NOISE vs. FREQUENCY | 50 | 25 | 805A0000, 80000141, 00009E42, E8000013, 618160FC, 00400005 | 40k | 0.1μ | 120 | 0.012μ | 250 | 820p | |
| 6.0GHz CLOSED-LOOP PHASE NOISE vs. FREQUENCY | 50 | 25 | 80780000, 0080000141, 00009E42, EA000013, 608C80FC, 00400005 | 40k | 0.1μ | 120 | 0.012μ | 250 | 820p | |
| 904MHz INTEGER-N MODE PHASE NOISE AND SPUR PERFORMANCE vs. FREQUENCY | 40 | 0.8 | 82350000, 800007D1 E1065FC2, 2C000013 6020803C 00400005 | 16k | 0.1μ | 806 | 3300p | 1201 | 470p | |
| 2687.5MHz INTEGER-N PHASE NOISE AND SPUR PERFORMANCE vs. FREQUENCY | 40 | 0.5 | 94FF0000, 803207D1, 010A1E42, B00000A3, 6090803C, 00400005 | 5k | 0.1μ | 1000 | 6800p | 300 | 0.01μ | |
| 2113.5MHz FRACTIONAL-N PHASE NOISE (LOW-NOISE MODE) vs. FREQUENCY | 50 | 25 | 00548050, 400003E9, 81005FC2, E8000013, 609C80FC, 00400005 | 40k | 0.1μ | 120 | 0.012μ | 250 | 820p | |
| 2113.5MHz FRACTIONAL-N PHASE NOISE vs. FREQUENCY (LOW-SPUR MODE) | 50 | 25 | 00548050, 400003E9, E1005FC2, E8000013, 609C80FC, 00400005 | 40k | 0.1μ | 120 | 0.012μ | 250 | 820p | |

23.5MHz to 6000MHz Fractional/ Integer-N Synthesizer/VCO

Typical Operating Characteristics Testing Conditions Table

| TOC TITLE | f _{REF} (MHz) | f _{PDF} (MHz) | REGISTER SETTINGS (hex) | TOC TITLE | MAX2870 EV KIT COMPONENT VALUES | | | | | COMMENTS |
|---|---------------------------|---------------------------|--|--------------|---------------------------------|----------------|------------|-----------|------------|---|
| | | | | | C13 (F) | R1 + R2 (Ω) | C14 (F) | R0 (Ω) | C12 (F) | |
| 2679.4MHz FRACTIONAL-N PHASE NOISE vs. FREQUENCY (LOW-NOISE MODE) | 50 | 25 | 00358160, 203207D1, 01005E42, B20000A3, 6010003C, 00400005 | 40k | 0.1μ | 120 | 0.012μ | 250 | 820p | |
| 2679.4MHz FRACTIONAL-N PHASE NOISE vs. FREQUENCY (LOW-SPUR MODE) | | 25 | 00358160, 203207D1, 41005E42, B20000A3, 6010003C, 00400005 | 40k | 0.1μ | 120 | 0.012μ | 250 | 820p | |
| SUPPLY CURRENT vs. OUTPUT POWER SETTING (ONE CHANNEL ACTIVE, 3GHz) | 50 | 25 | 003C0000, 20000321, 01005E42, 00000013, 610F423C, 01400005, | | | | | | | APWR swept from 00 to 11 |
| SUPPLY CURRENT vs. FREQUENCY (ONE CHANNEL ACTIVE, MAXIMUM OUTPUT POWER) | 50 | 25 | 003C0000, 20000321, 01005E42, 00000013, 610F423C, 01400005 | | | | | | | N and F values changed for each frequency |
| SUPPLY CURRENT vs. OUTPUT POWER SETTING (TWO CHANNELS ACTIVE) | 50 | 25 | 003C0000, 20000321, 01005E42, 00000013, 610F43FC, 01400005 | | | | | | | APWR and BPWR swept from 00 to 11 |
| SUPPLY CURRENT vs. FREQUENCY (TWO CHANNELS ACTIVE MAXIMUM OUTPUT POWER) | 50 | 25 | 003C0000, 20000321, 01005E42, 00000013, 610F43FC, 01400005 | | | | | | | N and F values swept for each frequency |
| PLL LOCK vs. TIME | 40 | 40 | 00250120, 20320141, 00004042, 000000A3, 0184023C, 01400005 | 40k | 0.1μ | 120 | 0.012μ | 250 | 820p | CDM changed from 00 to 01 |

MAX2870

23.5MHz to 6000MHz Fractional/ Integer-N Synthesizer/VCO

Pin Configuration

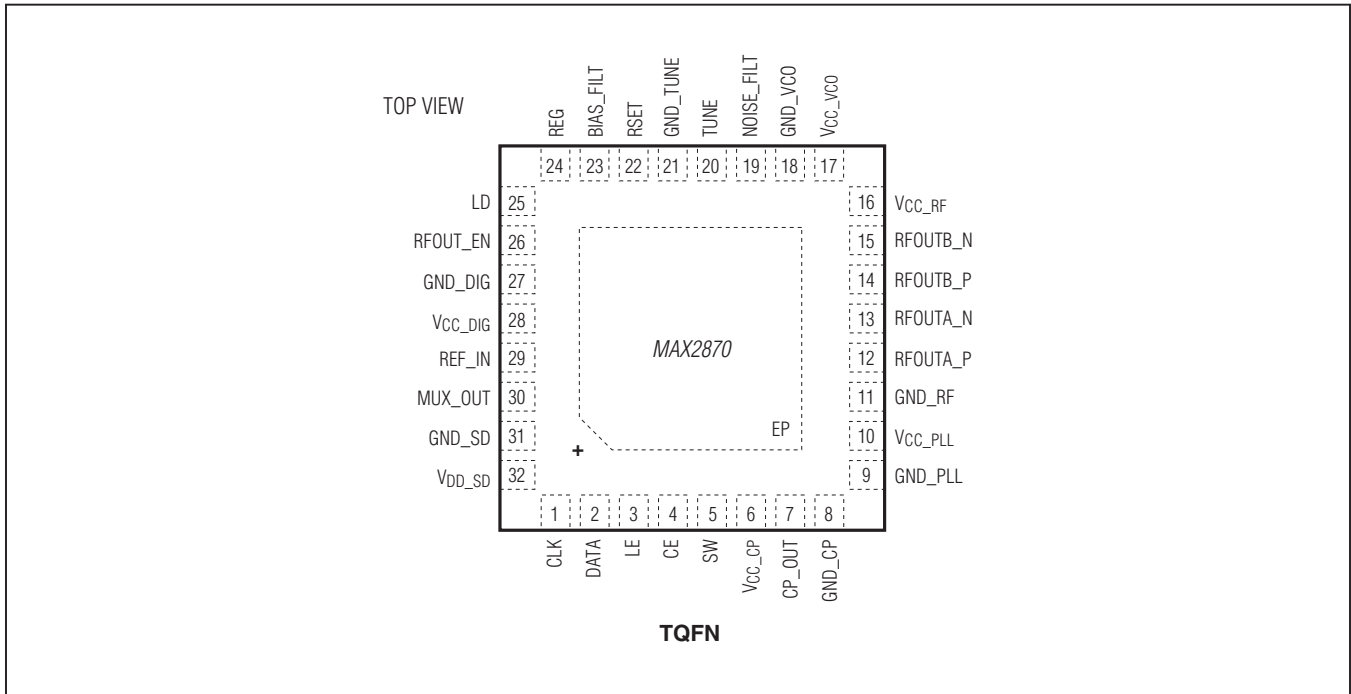

Pin Description

| PIN | NAME | FUNCTION |
|-----|---------------------|--|
| 1 | CLK | Serial Clock Input. The data is latched into the 32-bit shift register on the rising edge of the CLK line. |
| 2 | DATA | Serial Data Input. The serial data is loaded MSB first. The 3 LSBs identify the register address. |
| 3 | LE | Load Enable Input. When LE goes high the data stored in the shift register is loaded into the appropriate latches. |
| 4 | CE | Chip Enable. A logic-low powers the part down and the charge pump becomes high impedance. |
| 5 | SW | Fast-Lock Switch. Connect to the loop filter when using the fast-lock mode. |
| 6 | V _{CC_CP} | Power Supply for Charge Pump. Place decoupling capacitors as close as possible to the pin. |
| 7 | CP_OUT | Charge-Pump Output. Connect to external loop filter input. |
| 8 | GND_CP | Ground for Charge-Pump. Connect to board ground, not to the paddle. |
| 9 | GND_PLL | Ground for PLL. Connect to main board ground plane, not to the paddle. |
| 10 | V _{CC_PLL} | Power Supply for PLL. Place decoupling capacitors as close as possible to the pin. |
| 11 | GND_RF | Ground for RF Outputs. Connect to board ground plane, not to the paddle. |
| 12 | RFOUTA_P | Open Collector Positive RF Output A. Connect to supply through RF choke or 50Ω load. |
| 13 | RFOUTA_N | Open Collector Negative RF Output A. Connect to supply through RF choke or 50Ω load. |

MAX2870

23.5MHz to 6000MHz Fractional/ Integer-N Synthesizer/VCO

Pin Description (continued)

| PIN | NAME | FUNCTION |
|-----|---------------------|---|
| 14 | RFOUTB_P | Open Collector Positive RF Output B. Connect to supply through RF choke or 50Ω load. |
| 15 | RFOUTB_N | Open Collector Negative RF Output B. Connect to supply through RF choke or 50Ω load. |
| 16 | V _{CC_RF} | Power Supply for RF Output and Dividers. Place decoupling capacitors as close as possible to the pin. |
| 17 | V _{CC_VCO} | VCO Power Supply. Place decoupling capacitors to the analog ground plane. |
| 18 | GND_VCO | Ground for VCO. Connect to external paddle. |
| 19 | NOISE_FILT | VCO Noise Decoupling. Place a 1μF capacitor to ground. |
| 20 | TUNE | Control Input to the VCO. Connect to external loop filter. |
| 21 | GND_TUNE | Ground for Control Input to the VCO. Connect to external paddle. |
| 22 | RSET | Charge-Pump Current Range Input. Connect an external resistor to ground to set the minimum CP current. $I_{CP} = 1.63/R_{SET} \times (1 + CP)$ |
| 23 | BIAS_FILT | VCO Noise Decoupling. Place a 1μF capacitor to ground. |
| 24 | REG | Reference Voltage Compensation. Place a 1μF capacitor to ground. |
| 25 | LD | Lock Detect Output. Logic-high when locked, and logic-low when unlocked. See register description for more details (Table 9). |
| 26 | RFOUT_EN | RF Output Enable. A logic-low disables the RF outputs. |
| 27 | GND_DIG | Ground for Digital circuitry. Connect to main board ground plane, not directly to the paddle. |
| 28 | V _{CC_DIG} | Power Supply for Digital Circuitry. Place decoupling capacitors as close as possible to pin. |
| 29 | REF_IN | Reference Frequency Input. This is a high-impedance input with a nominal bias voltage of V _{CC_DIG} /2. AC-couple to reference signal. |
| 30 | MUX_OUT | Multiplexed Output and Serial Data Out. See Table 6. |
| 31 | GND_SD | Ground for Sigma-Delta Modulator. Connect to main board ground plane, not directly to the paddle. |
| 32 | V _{CC_SD} | Power Supply for Sigma-Delta Modulator. Place decoupling capacitors as close as possible to the pin. |
| — | EP | Exposed Pad. Connect to board ground. |

23.5MHz to 6000MHz Fractional/Integer-N Synthesizer/VCO

Detailed Description

4-Wire Serial Interface

The MAX2870 serial interface contains five write-only and one read-only 32-bit registers. The 29 most-significant bits (MSBs) are data, and the three least-significant bits (LSBs) are the register address. Register data is loaded MSB first through the 4-wire serial interface (SPI). When LE is logic-low, the logic level at DATA is shifted at the rising edge of CLK. At the rising edge of LE, the 29 data bits are latched into the register selected by the address bits. The user must program all register values after power-up.

Register programming order should be address 0x05, 0x04, 0x03, 0x02, 0x01, and 0x00. Several bits are double buffered to update the settings at the same time. See the register descriptions for double buffered settings.

Register 0x06 can be read back through MUX_OUT. The user must set MUX = 1100. To begin the read sequence, set LE to logic-low, send 32 periods of CLK, and set LE to logic-high. While the CLK is running, the DATA pin can be held at logic-high or logic-low for 29 clocks, but the last 3 bits must be 110 to indicate register 6. Then finally, send 1 period of the clock. The MSB of register 0x06 appears on the falling edge of the next clock and continues to shift out for the next 29 clock cycles (Figure 2). After the LSB of register 0x06 has been read, the user can reset MUX = 0000.

Power Modes

The MAX2870 can be put into low-power mode by setting SHDN = 1 (register 2, bit 5) or by setting the CE pin to logic-low.

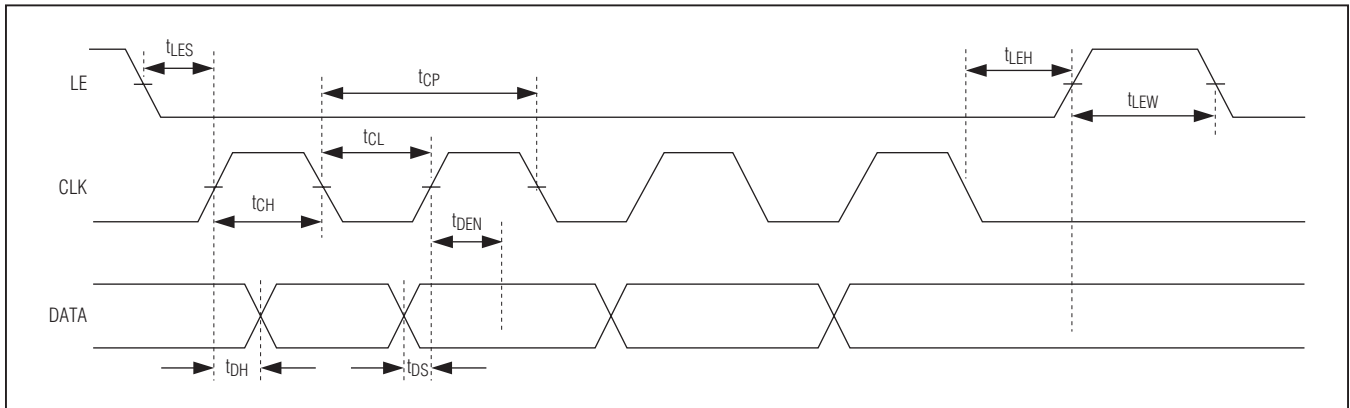

Figure 1. SPI Timing Diagram

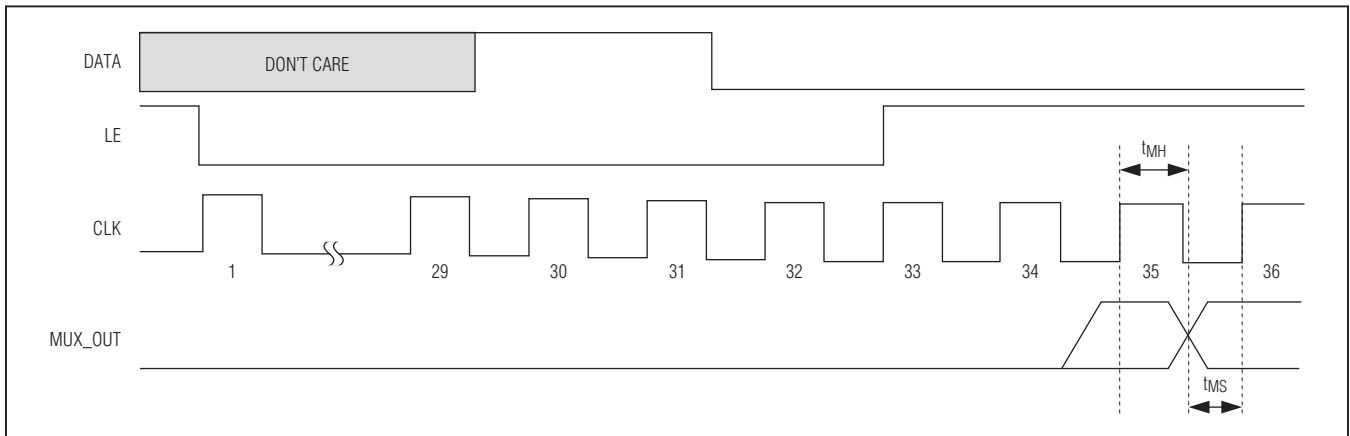

Figure 2. Initiating Readback

23.5MHz to 6000MHz Fractional/ Integer-N Synthesizer/VCO

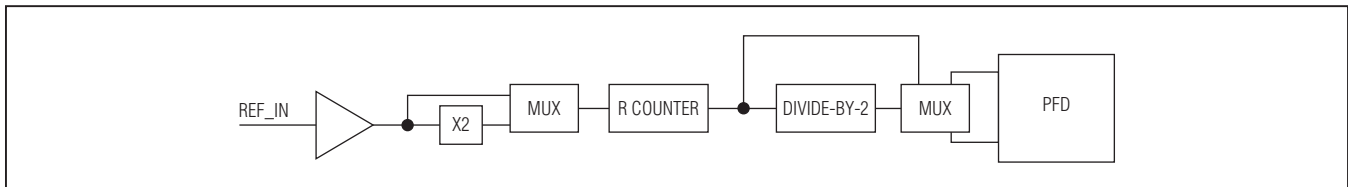

Figure 3. Reference Input

Reference Input

The reference input stage is configured as a CMOS inverter with shunt resistance from input to output. In shutdown mode this input is set to high impedance to prevent loading of the reference source.

The reference input signal path also includes optional x2 and ÷2 blocks. When the reference doubler is enabled (DBR = 1), the maximum reference input frequency is limited to 100MHz. When the doubler is disabled, the reference input frequency is limited to 200MHz. The minimum reference frequency is 10MHz. The minimum R counter divide ratio is 1, and the maximum divide ratio is 1023.

Int, Frac, Mod, and R Counter Relationship

The phase-detector frequency is determined as follows:

$$f_{\text{PFD}} = f_{\text{REF}} \times [(1 + \text{DBR}) / (\text{R} \times (1 + \text{RDIV2}))]$$

f_{REF} represents the external reference input frequency. DBR (register 2, bit 25) sets the f_{REF} input frequency doubler mode (0 or 1). RDIV2 (register 2, bit 24) sets the f_{REF} divide-by-2 mode (0 or 1). R (register 2, bits 23:14) is the value of the 10-bit programmable reference counter (1 to 1023). The maximum f_{PFD} is 50MHz for frac-N mode and 105MHz for int-N mode. The R-divider can be held in reset when RST (register 2, bit 3) = 1.

The VCO frequency (f_{VCO}), N, F, and M can be determined based on desired RF output frequency (f_{RFOUTA}) as follows:

Set DIVA value property based on f_{RFOUTA} and DIVA register table (register 4[22:20])

$$f_{\text{VCO}} = f_{\text{RFOUTA}} \times \text{DIVA}$$

If bit FB = 1, (DIVA is not in PLL feedback loop):

$$(N + (F/M)) = f_{\text{VCO}} / f_{\text{PFD}}$$

If bit FB = 0, (DIVA is in PLL feedback loop) and DIVA ≤ 16:

$$(N + (F/M)) = (f_{\text{VCO}} / f_{\text{PFD}}) / \text{DIVA}$$

If bit FB = 0, (DIVA is in PLL feedback loop) and DIVA > 16:

$$(N + (F/M)) = (f_{\text{VCO}} / f_{\text{PFD}}) / 16$$

N is the value of the 16-bit N counter (16 to 65535), programmable through bits 30:15 of register 0. M is the fractional modulus value (2 to 4095), programmable through bits 14:3 of register 1. F is the fractional division value (0 to MOD - 1), programmable through bits 14:3 of register 0. In frac-N mode, the minimum N value is 19 and maximum N value is 4091. The N counter is held in reset when RST = 1 (register 2, bit 3). DIVA is the RF output divider setting (0 to 7), programmable through bits 22:20 of register 4. The division ratio is set by 2^{DIVA} .

The RF B output frequency is determined as follows:

If BDIV = 0 (register 4, bit 9), $f_{\text{RFOUTB}} = f_{\text{RFOUTA}}$.

If BDIV = 1, $f_{\text{RFOUTB}} = f_{\text{VCO}}$.

Int-N/Frac-N Modes

Integer-N mode is selected by setting bit INT = 1 (register 0, bit 31). When operating in integer-N mode, it is also necessary to set bit LDF (register 2, bit 8) to set the lock detect to integer-N mode.

The device's frac-N mode is selected by setting bit INT = 0 (register 0, bit 31). Additionally, set bit LDF = 0 (register 2, bit 8) for frac-N lock-detect mode.

If the device is in frac-N mode, it will remain in frac-N mode when fractional division value F = 0, which can result in unwanted spurs. To avoid this condition, the device can automatically switch to integer-N mode when F = 0 if the bit F01 = 1 (register 5, bit 24).

Phase Detector and Charge Pump

The device's charge-pump current is determined by the value of the resistor from pin RSET to ground and the value of bits CP (register 2, bits 12:9) as follows:

$$I_{\text{CP}} = 1.63 / \text{RSET} \times (1 + \text{CP})$$

To reduce spurious in frac-N mode, set charge-pump linearity bit CPL = 1 (register 1, bits 30:29). For int-N mode, set CPL = 0. For lower noise operation in int-N mode, set charge-pump output clamp bit CPOC = 1 (register 1, bit 31) to prevent leakage current onto the loop filter. For frac-N mode, set CPOC = 0.

23.5MHz to 6000MHz Fractional/ Integer-N Synthesizer/VCO

The charge-pump output can be put into high-impedance mode when TRI = 1 (register 2, bit 4). The output is in normal mode when TRI = 0.

The phase detector polarity can be changed if an active inverting loop filter topology is used. For noninverting loop filters, set PDP = 1 (register 2, bit 6). For inverting loop filters, set PDP = 0.

MUX_OUT and Lock Detect

MUX_OUT is a multipurpose test output for observing various internal functions of the MAX2870. MUX_OUT can also be configured as serial data output. Bits MUX (register 2, bit 28:26) are used to select the desired MUX_OUT signal (see Table 6).

Lock detect can be monitored through the LD output by setting the LD bits (register 5, bits 23:22). For digital lock detect, set LD = 01. The digital lock detect is dependent on the mode of the synthesizer. In frac-N mode set LDF = 0, and in int-N mode set LDF = 1. To set the accuracy of the digital lock detect, see Tables 1 and 2.

Analog lock detect can be set with LD = 10. In this mode, LD is an open-drain output and requires an external pullup resistor.

Fast-Lock

The device uses a fast-lock mode to decrease lock time. This mode requires that CP = 0000 (register 2, bits 12:9) and that the shunt resistive portion of the loop filter be segmented into two parts, where one resistor is 1/4th the total resistance, and the other resistor is 3/4th the total resistance. The larger resistor should be connected from ground to SW, and the smaller resistor from SW to

the loop filter capacitor. When CDM = 01 (register 3, bits 16:15), fast-lock is active after the VAS has completed. During fast-lock, the charge pump is increased to CP = 1111 and the shunt loop filter resistance is set to 1/4th the total resistance by changing pin SW from high impedance to ground. Fast-lock deactivates after a timeout set by the user. This timeout is loop filter dependent, and is set by:

$$t_{\text{FAST-LOCK}} = M \times \text{CDIV} / f_{\text{REF}}$$

where M is the modulus setting and CDIV is the clock divider setting. The user must determine the CDIV setting based on their loop filter time constant.

RFOUTA± and RFOUTB±

The device has dual differential open-collector RF outputs that require an external RF choke 50Ω resistor to supply for each output. Each differential output can be independently enabled or disabled by setting bits RFA_EN (register 4, bit 5) and RFB_EN (register 4, bit 8). Both outputs are also controlled by applying a logic-high (enabled) or logic-low (disabled) to pin RFOUT_EN.

The output power of each output can be individually controlled with APWR (register 4, bits 4:3) for RFOUTA and BPWR (register 4, bits 7:6) for RFOUTB. The available differential output power settings are from -4dBm to +5dBm, in 3dB steps with 50Ω pullup to supply. The available single-ended output power ranges from -4dBm to +5dBm in 3dB steps with a RF choke to supply. Across the entire frequency range different pullup elements (L or R) are required for optimal output power. If the output is used single ended, the unused output should be terminated in a corresponding load.

Table 1. Frac-N Digital Lock-Detect Settings

| PFD FREQUENCY | LDS | LDP | LOCKED UP/DOWN TIME SKEW (ns) | NUMBER OF LOCKED CYCLES TO SET LD | UP/DOWNTIME SKEW TO UNSET LD (ns) |
|---------------|-----|-----|-------------------------------|-----------------------------------|-----------------------------------|
| ≤ 32MHz | 0 | 0 | 10 | 40 | 15 |
| ≤ 32MHz | 0 | 1 | 6 | 40 | 15 |
| > 32MHz | 1 | X | 4 | 40 | 4 |

Table 2. Int-N Digital Lock-Detect Settings

| PFD FREQUENCY | LDS | LDP | LOCKED UP/DOWN TIME SKEW (ns) | NUMBER OF LOCKED CYCLES TO SET LD | UP/DOWNTIME SKEW TO UNSET LD (ns) |
|---------------|-----|-----|-------------------------------|-----------------------------------|-----------------------------------|
| ≤ 32MHz | 0 | 0 | 10 | 5 | 15 |
| ≤ 32MHz | 0 | 1 | 6 | 5 | 15 |
| > 32MHz | 1 | X | 4 | 5 | 4 |

23.5MHz to 6000MHz Fractional/ Integer-N Synthesizer/VCO

Voltage-Controlled Oscillator

The fundamental VCO frequency of the device guarantees gap-free coverage from 3.0GHz to 6.0GHz using four individual VCO core blocks with 16 sub-bands within each block. Connect the output of the loop filter to the TUNE input. The TUNE input is used to control the VCO.

Tune ADC

A 3-bit ADC is used to read the VCO tuning voltage. The ADC value can be read back by bits 22:20 in register 6. The ADC uses the ranges shown in Table 3.

Note that the digital or analog lock detect might still be valid when the tuning voltage is out of the compliance range.

VCO Autoselect (VAS) State Machine

An internal VCO autoselect state machine is initiated when register 0 is programmed to automatically select the correct VCO if bit VAS_SHDN = 0 (register 3, bit 25). If VAS_SHDN = 1, then the VCO can be manually selected by bits VCO.

The state machine clock, f_{BS} , must be set to 50kHz. This is set by the BS bits. The formula for setting BS is:

$$BS = f_{REF}/50kHz$$

where f_{REF} is the reference frequency. The BS (register 4, bits 19:12) value should be rounded to the nearest integer. If the calculated BS is higher than 1023, then set BS = 1023. If f_{REF} is lower than 50kHz, then set BS = 1. The time needed to select the correct VCO is $10/f_{BS}$.

The RETUNE (register 3, bit 24) bit is used to enable or disable the VAS auto-retune function. Should the 3-bit TUNE ADC detect that the VCO control voltage (V_{TUNE}) has drifted into the 000 or 111 state, the VAS will initiate an auto-retune if RETUNE = 1. If RETUNE = 0, then this function is disabled.

Table 3. ADC VCO Status

| ADC | VCO STATUS |
|-----|-----------------------------------|
| 000 | Out-of-lock, $V_{TUNE} < 0.5V$ |
| 001 | In-lock, $0.5V < V_{TUNE} < 0.7V$ |
| 010 | In-lock, $0.7V < V_{TUNE} < 1.3V$ |
| 011 | Not used |
| 100 | Not used |
| 101 | In-lock, $1.3V < V_{TUNE} < 2.1V$ |
| 110 | In-lock, $2.1V < V_{TUNE} < 2.5V$ |
| 111 | Out-of-lock, $V_{TUNE} > 2.5V$ |

Phase Shift Mode

After achieving lock, the phase of the RF output can be changed in increments of $P/M \times 360^\circ$. The absolute phase cannot be determined, but it can be changed relative to the current phase.

To change the phase, do the following:

- 1) Achieve lock at the desired frequency.
- 2) Set the increment of phase relative to the current phase by setting $P = M \times \{\text{desired_phase_change}\}/360^\circ$.
- 3) Enable the phase change by setting CDM = 10.
- 4) Reset CDM = 00.

Low-Spur Mode

The device offers three modes for the sigma-delta modulator. Low-noise mode offers lower in-band noise at the expense of spurs. The spurs can be reduced by setting SDN = 10 (register 2, bits 30:29) or SDN = 11 for different modes of dithering. The user can determine which mode works best for their application.

23.5MHz to 6000MHz Fractional/ Integer-N Synthesizer/VCO

Register and Bit Descriptions

The operating mode of the device is controlled by five on-chip registers.

Defaults are not guaranteed upon power-up and are provided for reference only. All reserved bits should only be written with default values. In low-power mode the register values are retained.

Table 4. Register 0 (Address: 000, Default: 007D0000_{HEX})

| BIT LOCATION | BIT ID | NAME | DEFINITION |
|--------------|------------|------------------------------|---|
| 31 | INT | Int-N or Frac-N Mode Control | 0 = Enables the fractional-N mode 1 = Enables the integer-N mode The LDF bit must also be set to the appropriate mode. |
| 30:15 | N[15:0] | Integer Division Value | Sets integer part (N-divider) of the feedback divider factor. All integer values from 16 to 65,535 are allowed for integer mode. Integer values from 19 to 4,091 are allowed for fractional mode. |
| 14:3 | FRAC[11:0] | Fractional Division Value | Sets fractional value: 000000000000 = 0 (see F0I bit description) 000000000001 = 1 ---- 111111111110 = 4094 111111111111 = 4095 |
| 2:0 | ADDR[2:0] | Address Bits | Register address bits |

Table 5. Register 1 (Address: 001, Default: 2000FFF9_{HEX})

| BIT LOCATION | BIT ID | NAME | DEFINITION |
|--------------|----------|------------------|---|
| 31 | CPOC | CP Output Clamp | Sets charge-pump output clamp mode. 0 = Disables clamping of the CP output when the CP is off 1 = Enables the clamping of the CP output when the CP is off (improved integer-N in-band phase noise) |
| 30:29 | CPL[1:0] | CP Linearity | Sets CP linearity mode. 00 = Disables the CP linearity mode (integer-N mode) 01 = Enables the CP linearity mode (frac-N mode) 10 = Reserved 11 = Reserved |
| 28:27 | CPT[1:0] | Charge Pump Test | Sets charge-pump test modes. 00 = Normal mode 01 = Reserved 10 = Force CP into source mode 11 = Force CP into sink mode |
| 26:15 | P[11:0] | Phase Value | Sets phase value. See the <i>Phase Shift Mode</i> section. 000000000000 = 0 000000000001 = 1 (recommended) ---- 111111111111 = 4095 |

23.5MHz to 6000MHz Fractional/ Integer-N Synthesizer/VCO

Table 5. Register 1 (Address: 001, Default: 2000FFF9_{HEX}) (continued)

| BIT LOCATION | BIT ID | NAME | DEFINITION |
|--------------|-----------|-------------------|--|
| 14:3 | M[11:0] | Modulus Value (M) | Fractional modulus value used to program f_{VCO} . See the <i>Int, Frac, Mod, and R Counter Relationship</i> section. Double buffered by register 0. 000000000000 = Unused 000000000001 = Unused 000000000010 = 2 ----- 111111111111 = 4095 |
| 2:0 | ADDR[2:0] | Address Bits | Register address bits |

Table 6. Register 2 (Address: 010, Default: 00004042_{HEX})

| BIT LOCATION | BIT ID | NAME | DEFINITION |
|--------------|----------|------------------------|--|
| 31 | LDS | Lock-Detect Speed | Lock-detect speed adjustment. 0 = $f_{PFD} \leq 32\text{MHz}$ 1 = $f_{PFD} > 32\text{MHz}$ |
| 30:29 | SDN[1:0] | Frac-N Noise Mode | Sets noise mode (See the <i>Low-Spur Mode</i> section.) 00 = Low-noise mode 01 = Reserved 10 = Low-spur mode 1 11 = Low-spur mode 2 |
| 28:26 | MUX[3:0] | MUX_OUT Configuration | Sets MUX_OUT pin configuration (MSB bit located register 05). 0000 = Three-state output 0001 = D_VDD 0010 = D_GND 0011 = R-divider output 0100 = N-divider output 0101 = Analog lock detect 0110 = Digital lock detect 0111:1011 = Reserved 1100 = Read register 06 MUX_OUT is configured as serial data out. 1101:1111 = Reserved |
| 25 | DBR | Reference Doubler Mode | Sets reference doubler mode. 0 = Disable reference doubler 1 = Enable reference doubler |
| 24 | RDIV2 | Reference Div2 Mode | Sets reference divider mode. 0 = Disable reference divide-by-2 1 = Enable reference divide-by-2 |
| 23:14 | R[9:0] | Reference Divider Mode | Sets reference divide value (R). Double buffered by register 0. 0000000000 = 0 (unused) 0000000001 = 1 ----- 1111111111 = 1023 |

23.5MHz to 6000MHz Fractional/ Integer-N Synthesizer/VCO

Table 6. Register 2 (Address: 010, Default: 00004042_{HEX}) (continued)

| BIT LOCATION | BIT ID | NAME | DEFINITION |
|--------------|---------|------------------------------|---|
| 13 | REG4DB | Double Buffer | Sets double buffer mode. 0 = Disabled 1 = Enabled |
| 12:9 | CP[3:0] | Charge-Pump Current | Sets charge-pump current in mA ($R_{SET} = 5.1k\Omega$). Double buffered by register 0. 0000 = 0.32 0001 = 0.64 0010 = 0.96 0011 = 1.28 0100 = 1.60 0101 = 1.92 0110 = 2.24 0111 = 2.56 [ICP = 1.63/RSET x (1 + CP<3:0>)] 1000 = 2.88 1001 = 3.20 1010 = 3.52 1011 = 3.84 1100 = 4.16 1101 = 4.48 1110 = 4.80 1111 = 5.12 |
| 8 | LDF | Lock-Detect Function | Sets lock-detect function. 0 = Frac-N lock detect 1 = Int-N lock detect |
| 7 | LDP | Lock-Detect Precision | Sets lock-detect precision. 0 = 10nS 1 = 6nS |
| 6 | PDP | Phase Detector Polarity | Sets phase detector polarity. 0 = Negative (for use with inverting active loop filters) 1 = Positive (for use with passive loop filters and noninverting active loop filters) |
| 5 | SHDN | Power-Down Mode | Sets power-down mode. 0 = Normal mode 1 = Device shutdown |
| 4 | TRI | Charge-Pump Three-State Mode | Sets charge-pump three-state mode. 0 = Disabled 1 = Enabled |
| 3 | RST | Counter Reset | Sets counter reset mode. 0 = Normal operation 1 = R and N counters reset |
| 2:0 | ADDR | Address Bits | Register address |

**23.5MHz to 6000MHz Fractional/
Integer-N Synthesizer/VCO****Table 7. Register 3 (Address: 011, Default: 000000BHEX)**

| BIT LOCATION | BIT ID | NAME | DEFINITION |
|---------------------|---------------|---------------------|---|
| 31:26 | VCO[5:0] | VCO | Manual selection of VCO and VCO sub-band when VAS is disabled. 000000 = VCO0 111111 = VCO63 |
| 25 | VAS_SHDN | VAS_SHDN | Sets VAS state machine mode. 0 = VAS enabled 1 = VAS disabled |
| 24 | RETUNE | RETUNE | Sets VAS response to temperature drift. 0 = VAS auto-retune over temp disabled 1 = VAS auto-retune over temp enabled |
| 23:18 | Reserved | Reserved | Reserved. Program to 000000. |
| 17 | Reserved | Reserved | Reserved. Program to 0. |
| 16:15 | CDM[1:0] | Clock Divider Mode | Sets clock divider mode. 00 = Clock divider off 01 = Fast-lock enabled 10 = Phase mode 11 = Reserved |
| 14:3 | CDIV[11:0] | Clock Divider Value | Sets 12-bit clock divider value. 000000000000 = Unused 000000000001 = 1 000000000010 = 2 ----- 111111111111 = 4095 |
| 2:0 | ADDR[2:0] | Address Bits | Register address |

**23.5MHz to 6000MHz Fractional/
Integer-N Synthesizer/VCO**

Table 8. Register 4 (Address: 100, Default: 6180B23C_{HEX})

| BIT LOCATION | BIT ID | NAME | DEFINITION |
|--------------|--------------|----------------------------|---|
| 31:26 | Reserved | Reserved | Reserved. Program to 011000. |
| 25:24 | BS_MSBs[1:0] | Band-Select MSBs | Band-select MSBs. See bits [19:12]. |
| 23 | FB | VCO Feedback Mode | Sets VCO to N counter feedback mode. 0 = Divided 1 = Fundamental |
| 22:20 | DIVA[2:0] | RFOUT_ Output Divider Mode | Sets RFOUT_ output divider mode. Double buffered by register 0 when REG4DB = 1. 000 = Divide by 1, if $3000\text{MHz} \leq f_{\text{RFOUTA}} \leq 6000\text{MHz}$ 001 = Divide by 2, if $1500\text{MHz} \leq f_{\text{RFOUTA}} < 3000\text{MHz}$ 010 = Divide by 4, if $750\text{MHz} \leq f_{\text{RFOUTA}} < 1500\text{MHz}$ 011 = Divide by 8, if $375\text{MHz} \leq f_{\text{RFOUTA}} < 750\text{MHz}$ 100 = Divide by 16, if $187.5\text{MHz} \leq f_{\text{RFOUTA}} < 375\text{MHz}$ 101 = Divide by 32, if $93.75\text{MHz} \leq f_{\text{RFOUTA}} < 187.5\text{MHz}$ 110 = Divide by 64, if $46.875\text{MHz} \leq f_{\text{RFOUTA}} < 93.75\text{MHz}$ 111 = Divide by 128, if $23.5\text{MHz} \leq f_{\text{RFOUTA}} < 46.875\text{MHz}$ |
| 19:12 | BS[7:0] | Band Select | Sets band select clock divider value. MSB are located in bits [25:24]. 0000000000 = Reserved 0000000001 = 1 0000000010 = 2 ---- 1111111111 = 1023 |
| 11 | Reserved | Reserved | Reserved. Program to 0. |
| 10 | Reserved | Reserved | Reserved. Program to 0. |
| 9 | BDIV | RFOUTB Output Path Select | Sets RFOUTB output path select. 0 = VCO divided output 1 = VCO fundamental frequency |
| 8 | RFB_EN | RFOUTB Output Mode | Sets RFOUTB output mode. 0 = Disabled 1 = Enabled |
| 7:6 | BPWR[1:0] | RFOUTB Output Power | Sets RFOUTB single-ended output power. See the <i>RFOUTA±</i> and <i>RFOUTB±</i> section. 00 = -4dBm 01 = -1dBm 10 = +2dBm 11 = +5dBm |
| 5 | RFA_EN | RFOUTA Output Mode | Sets RFOUTA output mode. 0 = Disabled 1 = Enabled |
| 4:3 | APWR[1:0] | RFOUTA Output Power | Sets RFOUTA single-ended output power. See the <i>RFOUTA±</i> and <i>RFOUTB±</i> section. 00 = -4dBm 01 = -1dBm 10 = +2dBm 11 = +5dBm |
| 2:0 | ADDR[2:0] | Register Address | Register address |

23.5MHz to 6000MHz Fractional/ Integer-N Synthesizer/VCO

Table 9. Register 5 (Address: 101, Default: 00400005_{HEX})

| BIT LOCATION | BIT ID | NAME | DEFINITION |
|--------------|-----------|--------------------------|--|
| 31:25 | Reserved | Reserved | Reserved. Program to 0000000. |
| 24 | F01 | F01 | Sets integer mode for F = 0. 0 = If F[11:0] = 0, then fractional-N mode is set 1 = If F[11:0] = 0, then integer-N mode is auto set |
| 23:22 | LD[1:0] | Lock-Detect Pin Function | Sets lock-detect pin function. 00 = Low 01 = Digital lock detect 10 = Analog lock detect 11 = High |
| 21:19 | Reserved | Reserved | Reserved. Program to 000. |
| 18 | MUX | MUX MSB | Sets mode at MUX_OUT pin (see register 2 [28:26]) |
| 17:3 | Reserved | Reserved | Reserved |
| 2:0 | ADDR[2:0] | Register Address | Register address bits |

Table 10. Register 6 (Read-Only Register)

| BIT LOCATION | BIT ID | NAME | DEFINITION |
|--------------|-----------|------------------|---|
| 31:24 | — | Reserved | Reserved |
| 23 | POR | Power_On_Reset | POR readback status. 0 = POR has been read back 1 = POR has not been read back (registers at default) |
| 22:20 | ADC[2:0] | VTUNE_ADC | Reads back the ADC reading of the V _{TUNE} (see the <i>Tune ADC</i> section) |
| 19:9 | — | Reserved | Reserved |
| 8:3 | V[5:0] | Active VCO | Reads back the current active VCO. 000000 = VCO0 111111 = VCO63 |
| 2:0 | ADDR[2:0] | Register Address | Register address bits |

MAX2870

23.5MHz to 6000MHz Fractional/ Integer-N Synthesizer/VCO

Typical Application Circuit

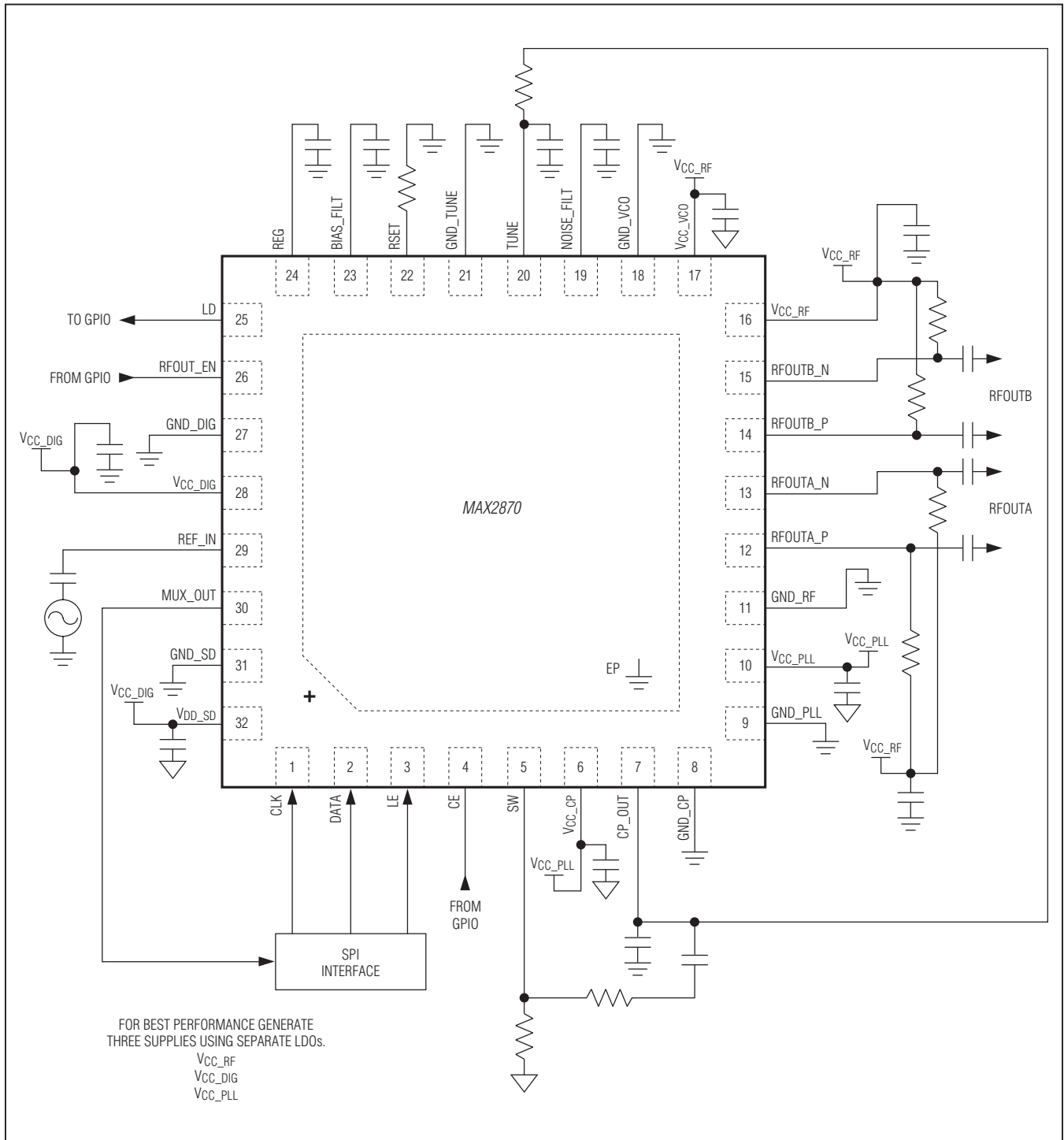

MAX2870

23.5MHz to 6000MHz Fractional/ Integer-N Synthesizer/VCO

Ordering Information

| PART | TEMP RANGE | PIN-PACKAGE |
|-------------|----------------|-------------|
| MAX2870ETJ+ | -40°C to +85°C | 32 TQFN-EP* |

+Denotes a lead(Pb)-free/RoHS-compliant package.

*EP = Exposed pad.

Package Information

For the latest package outline information and land patterns (footprints), go to www.maxim-ic.com/packages. Note that a "+", "#", or "-" in the package code indicates RoHS status only. Package drawings may show a different suffix character, but the drawing pertains to the package regardless of RoHS status.

| PACKAGE TYPE | PACKAGE CODE | OUTLINE NO. | LAND PATTERN NO. |
|--------------|--------------|-------------------------|-------------------------|
| 32 TQFN | T3255+5 | 21-0140 | 90-0013 |

MAX2870

23.5MHz to 6000MHz Fractional/ Integer-N Synthesizer/VCO

Revision History

| REVISION NUMBER | REVISION DATE | DESCRIPTION | PAGES CHANGED |
|-----------------|---------------|---|---------------|
| 0 | 4/12 | Initial release | — |
| 1 | 7/12 | Updated <i>Int, Frac, Mod and R Counter Relationship</i> section; updated formula in <i>VCO Autoselect (VAS) State Machine</i> section, updated Table 8 | 13, 15, 20 |

Maxim cannot assume responsibility for use of any circuitry other than circuitry entirely embodied in a Maxim product. No circuit patent licenses are implied. Maxim reserves the right to change the circuitry and specifications without notice at any time. The parametric values (min and max limits) shown in the Electrical Characteristics table are guaranteed. Other parametric values quoted in this data sheet are provided for guidance.

Maxim Integrated Products, Inc. 160 Rio Robles, San Jose, CA 95134 USA 1-408-601-1000 _____ **24**