

## CDBHD120L-G Thru. CDBHD1100L-G

Reverse Voltage: 20 to 100 Volts

Forward Current: 1.0 Amp

RoHS Device

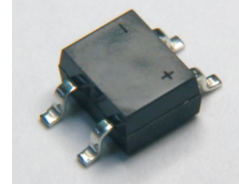

### Features

- Low Vf Schottky barrier chips in bridge
- Metal-Semiconductor junction with guard ring
- High surge current capability
- Silicon epitaxial planar chips
- For use in low voltage, high efficiency inverters, free wheeling, and polarity protection applications
- Lead-free part, meet RoHS requirements

### Mechanical data

- Case: Mini-Dip bridge (TO-269AA) plastic molded case
- Epoxy: UL94-V0 rated flame retardant
- Terminals: Solderable per MIL-STD-750 Method 2026
- Polarity: As marked on body
- Mounting Position: Any
- Weight: 0.0078 ounces, 0.22 grams

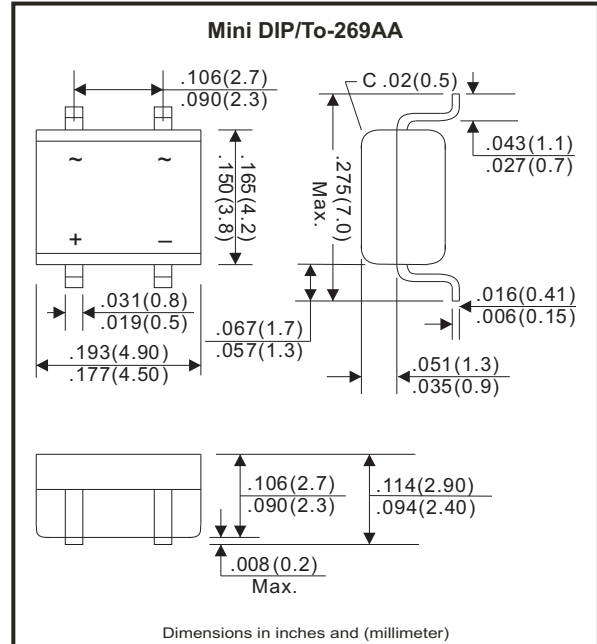

### Maximum Ratings and Electrical Characteristics

Parameter	Symbol	CDBHD 120L-G	CDBHD 140L-G	CDBHD 160L-G	CDBHD 180L-G	CDBHD 1100L-G	Units	
Maximum repetitive peak reverse voltage	$V_{RRM}$	20	40	60	80	100	V	
Maximum DC blocking voltage	$V_{DC}$	20	40	60	80	100	V	
Maximum RMS voltage	$V_{RMS}$	14	28	42	56	70	V	
Peak surge forward current 8.3ms single half sine-wave superimposed on rate load (JEDEC method)	$I_{FSM}$	30.0						A
Max. average forward current 0.2"×0.2"(5.0×5.0mm)copper pad area,see Figure 1	$I_{AV}$	1.0						A
Max. instantaneous forward voltage at 1.0A (Note 1)	$V_F$	0.44		0.625	0.75		V	
Max. DC reverse current at rated DC blocking voltage	$T_A=25^{\circ}C$	$I_R$ 0.50					mA	
	$T_A=100^{\circ}C$	$I_R$ 20.0						
Typical junction Capacitance (Note 2)	$C_J$	250			125		PF	
Typical thermal resistance (Note 3)	$R_{\theta JA}$	85.0					$^{\circ}C/W$	
	$R_{\theta JL}$	20.0						
Operating junction temperature Range	$T_J$	-55 to +125					$^{\circ}C$	
Storage temperature Range	$T_{STG}$	-55 to +150					$^{\circ}C$	

Note 1. Pulse test: 300μS pulse width, 1% duty cycle  
 2. Measured at 1.0MHz and applied reverse voltage of 4.0 Volts  
 3. Thermal resistance from junction to ambient and from junction to lead P.C.B. mounted on 0.2x0.2"(5.0x5.0mm) copper pad areas.

## RATING AND CHARACTERISTIC CURVES (CDBHD120L-G thru CDBHD1100L-G)

Fig.1 Forward Current Derating Curve

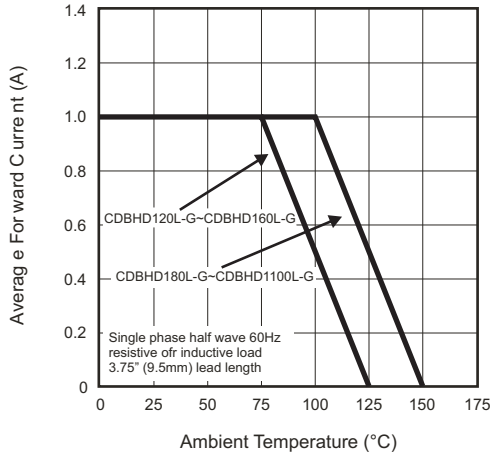

Fig.2 Maximum Non-Repetitive Peak Forward Surge Current

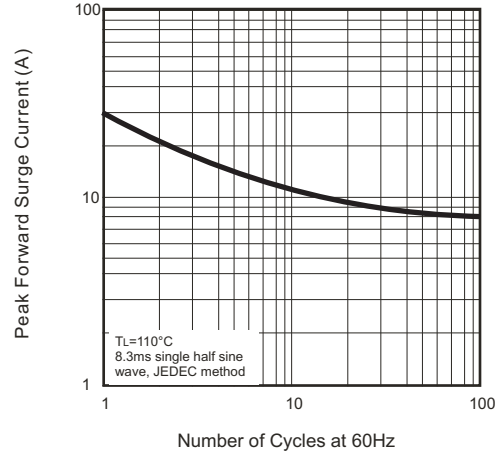

Fig.3- Typical Instantaneous Forward Characteristics

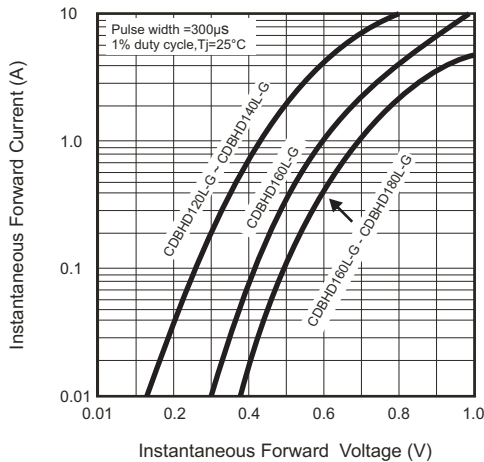

Fig.4A- Typical Reverse Characteristics

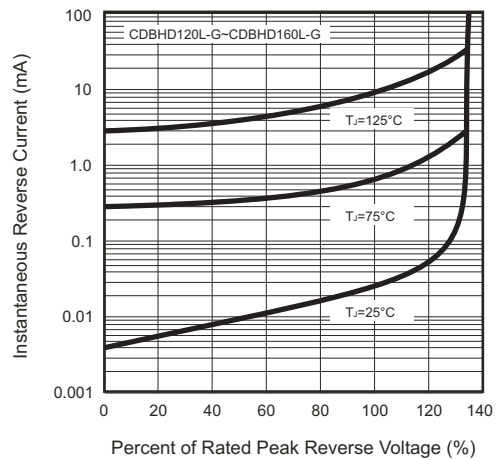

Fig.5 Maximum Non-Repetitive Peak Forward Surge Current

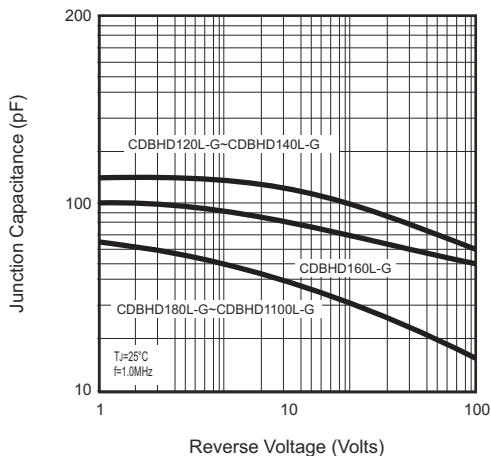
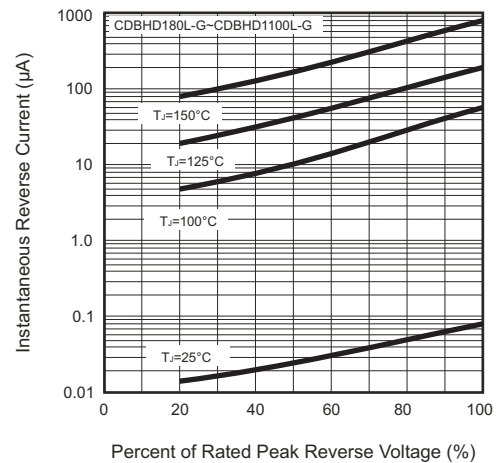
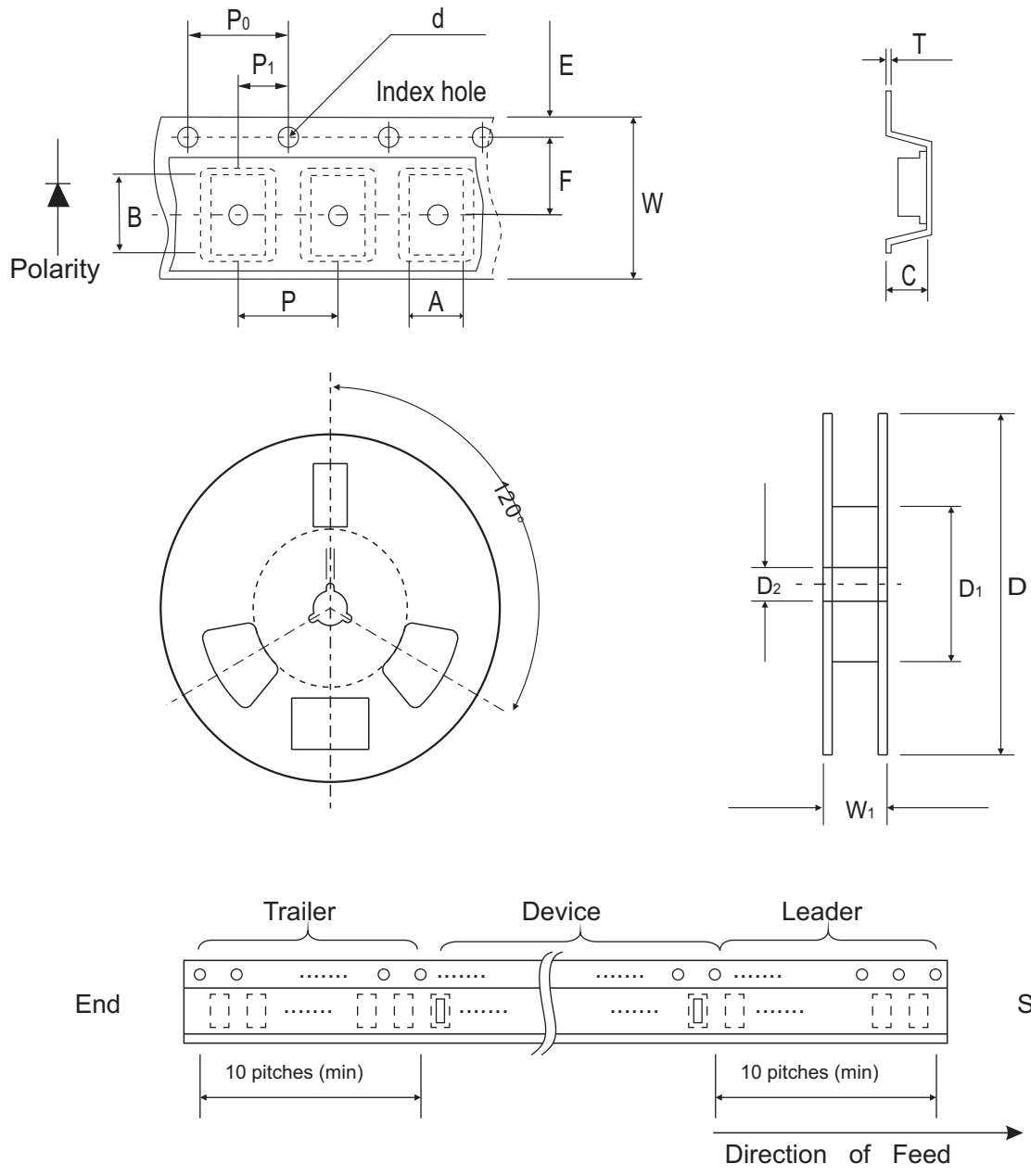

Fig.4B- Typical Reverse Characteristics



## Reel Taping Specification



Mini-DIP/TO-269AA	SYMBOL	A	B	C	d	D	D1	D2
	(mm)	5.00 ± 0.10	3.20 ± 0.10	2.90 ± 0.10	1.55 ± 0.10	330MAX	50 MIN.	13.00 ± 0.20
	(inch)	0.197 ± 0.004	0.126 ± 0.004	0.114 ± 0.004	0.061 ± 0.004	12.992MAX	1.969 MIN.	0.512 ± 0.008

Mini-DIP/TO-269AA	SYMBOL	E	F	P	P0	P1	W	W1
	(mm)	1.75 ± 0.10	5.50 ± 0.10	8.00 ± 0.10	4.00 ± 0.10	2.00 ± 0.05	12.00 ± 0.20	18.40 MAX
	(inch)	0.069 ± 0.004	0.138 ± 0.004	0.315 ± 0.004	0.157 ± 0.004	0.079 ± 0.004	0.472 ± 0.008	0.724MAX

## Marking Code

Part Number	Marking Code
CDBHD120L-G	MDS12L
CDBHD140L-G	MDS14L
CDBHD160L-G	MDS16L
CDBHD180L-G	MDS18L
CDBHD1100L-G	MDS110L

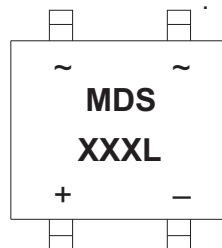

XXL / XXXL = Product type marking code

## Suggested PAD Layout

SIZE	Mini-DIP/TO-269AA	
	(mm)	(inch)
A	6.91Min	0.272Min
B	0.58Min	0.023Min
C	0.76Min	0.030Min
D	2.67Min	0.105Min

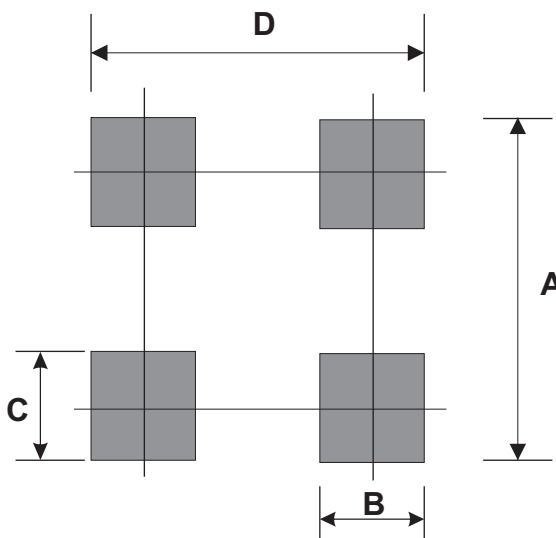

## Standard Packaging

Case Type	REEL PACK	
	REEL ( pcs )	Reel Size (inch)
Mini-DIP/TO-269AA	2,500	13