

VI TELEFILTER

Filter specification

TFS 76C

1/5

Measurement condition

Ambient temperature:	25	°C
Input power level:	0	dBm
Terminating impedance: *		
Input:	155 Ω -15,8 pF	
Output:	975 Ω -5,8 pF	

Characteristics

Remark:

The reference level for the relative attenuation a_{rel} of the TFS 76C is the minimum of the pass band attenuation a_{min} . The minimum of the pass band attenuation a_{min} is defined as the insertion loss a_e . The centre frequency f_c is the arithmetic mean value of the upper and lower frequencies at the 1 dB filter attenuation level relative to the insertion loss a_e . The nominal frequency f_N is fixed at 76 MHz without any tolerance. The given values for both the relative attenuation a_{rel} and the group delay ripple have to be achieved at the frequencies given below even if the centre frequency f_c is shifted due to the temperature coefficient of frequency TC_f in the operating temperature range and due to a production tolerance for the centre frequency f_c .

Data		typ. value	tolerance / limit
Insertion loss (reference level)	a_e	18,3 dB	max. 19 dB
Nominal frequency	f_N	-	76,1 MHz
Passband	PB	-	$f_N \pm 12,5$ MHz
Amplitude ripple in PB	p-p	0,7 dB	max. 1 dB
Relative attenuation	a_{rel}		
$f_N - 12,5$ MHz ... $f_N + 12,5$ MHz		0,7 dB	max. 1 dB
$f_N - 13$ MHz ... $f_N + 13$ MHz		2,5 dB	max. 3 dB
$f_N - 60$ MHz ... $f_N - 16,5$ MHz		55 dB	min. 40 dB
$f_N + 17,5$ MHz ... $f_N + 21,5$ MHz		45 dB	min. 35 dB
$f_N + 21,5$ MHz ... $f_N + 42,5$ MHz		50 dB	min. 40 dB
Average group delay in PB		0,7 µs	max 1 µs
Group delay ripple in PB	p-p	40 ns	max. 150 ns
Phase linearity in PB	p-p	4 deg	max. 10 deg
Input / Output return loss @ f_N		11 / 16 dB	min. 10 dB
Operating temperature range	OTR	-	-10 °C ... + 70 °C
Storage temperature range		-	-35 °C ... + 85 °C
Temperature coefficient of frequency	TC_f^{**}	92 ppm/K	-

*) The terminating impedances depend on parasitics and q-values of matching elements and the board used, and are to be understood as reference values only. Should there be additional questions do not hesitate to ask for an application note or contact our design team.

**) $\Delta f_c(\text{Hz}) = TC_f(\text{ppm/K}) \times (T - T_0) \times f_{T0}(\text{MHz})$.

Generated:

Checked / Approved:

Tele Filter GmbH
Potsdamer Straße 18
D 14 513 TELTOW / Germany
Tel: (+49) 3328 4784-0 / Fax: (+49) 3328 4784-30
E-Mail: tft@telefilter.com

VI TELEFILTER reserves the right to make changes to the product(s) and/or information contained herein without notice. No liability is assumed as a result of their use or application. No rights under any patent accompany the sale of any such product(s) or information.

Filter characteristic

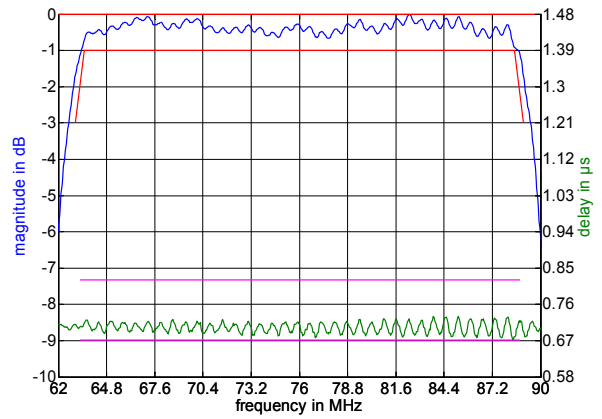
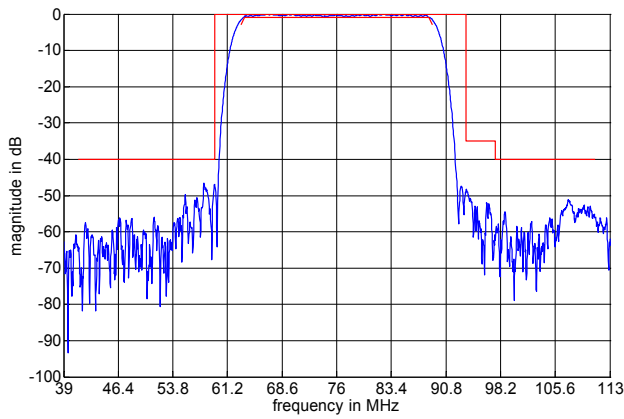

Construction and pin connection

(All dimensions in mm)

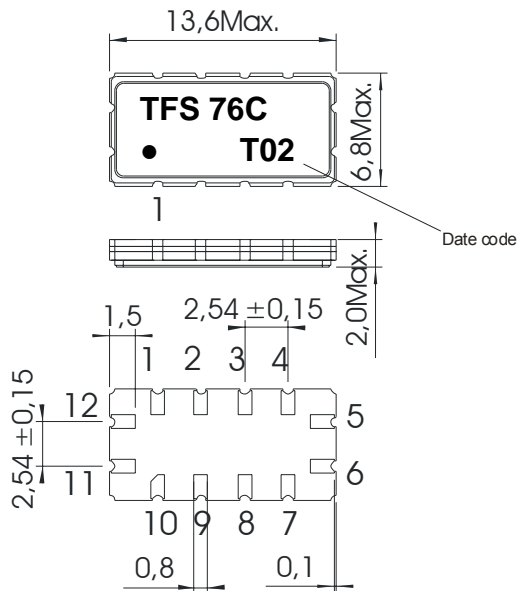

1	Ground
2	Ground
3	Ground
4	Ground
5	Output
6	Output RF Return
7	Ground
8	Ground
9	Ground
10	Ground
11	Input
12	Input RF Return

Date code: Year + week
 T 2005
 U 2006
 V 2007
 ...

50 Ohm Test circuit

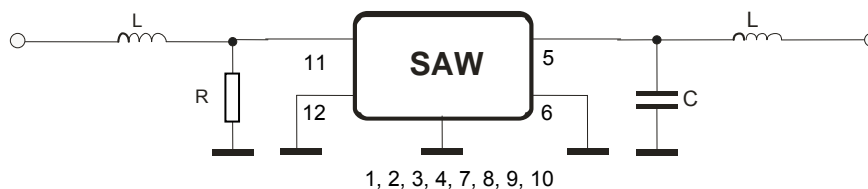

Tele Filter GmbH
 Potsdamer Straße 18
 D 14 513 TELTOW / Germany
 Tel: (+49) 3328 4784-0 / Fax: (+49) 3328 4784-30
 E-Mail: tft@telefilter.com

VI TELEFILTER reserves the right to make changes to the product(s) and/or information contained herein without notice. No liability is assumed as a result of their use or application. No rights under any patent accompany the sale of any such product(s) or information.

Stability characteristics

After the following tests the filter shall meet the whole specification:

1. Shock: 500g, 18 ms, half sine wave, 3 shocks each plane;
DIN IEC 68 T2 - 27
2. Vibration: 10 Hz to 500 Hz, 0,35 mm or 5 g respectively, 1 octave per min, 10 cycles per plan, 3 plans;
DIN IEC 68 T2 - 6
3. Change of temperature: -55 °C to 125°C / 30 min. each / 10 cycles
DIN IEC 68 part 2 – 14 Test N
4. Resistance to solder heat (reflow): reflow possible: twice max.;
for temperature conditions refer to the attached "Air reflow temperature conditions" on page 4;

Packing

Tape & Reel: IEC 286 – 3, with exception of value for N and minimum bending radius;
tape type II, embossed carrier tape with top cover tape on the upper side;

max. pieces of filters peer reel: 1700
reel of empty components at start: min. 300 mm
reel of empty components at start including leader: min. 500 mm
trailer: min. 300 mm

Tape (all dimensions in mm)

- W : 24,00 +0,30/-0,10
- Po : 4,00 ± 0,1
- Do : 1,50 +0,1/-0
- E : 1,75 ± 0,10
- F : 11,50 ± 0,10
- G(min) : 0,60
- P2 : 2,00 ± 0,1
- P1 : 12,00 ± 0,1
- D1(min) : 1,50
- Ao : 7,10 ± 0,10
- Bo : 13,90 ± 0,10
- Ct : 21,5 ± 0,1

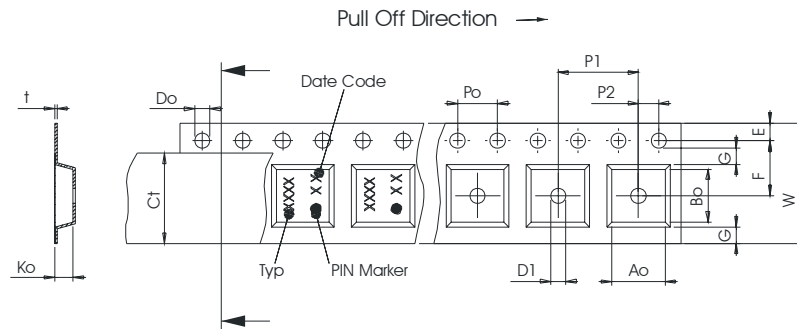

Reel (all dimensions in mm)

- A : 330
- W1 : 24,4 +2/-0
- W2(max) : 30,4
- N(min) : 60
- C : 13,0 +0,5/-0,2

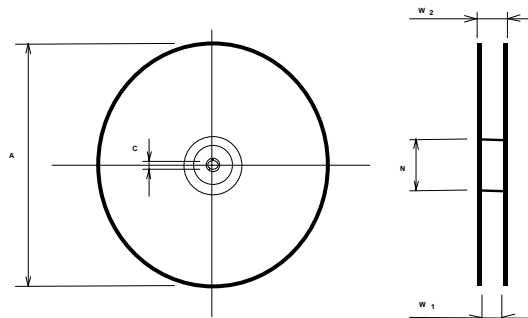

The minimum bending radius is 45 mm.

Tele Filter GmbH
Potsdamer Straße 18
D 14 513 TELTOW / Germany
Tel: (+49) 3328 4784-0 / Fax: (+49) 3328 4784-30
E-Mail: tft@telefilter.com

VI TELEFILTER reserves the right to make changes to the product(s) and/or information contained herein without notice. No liability is assumed as a result of their use or application. No rights under any patent accompany the sale of any such product(s) or information.

Air reflow temperature conditions

Conditions	Exposure
Average ramp-up rate (30°C to 217°C)	less than 3°C/second
> 100°C	between 300 and 600 seconds
> 150°C	between 240 and 500 seconds
> 217°C	between 30 and 150 seconds
Peak temperature	max. 260°C
Time within 5°C of actual peak temperature	between 10 and 30 seconds
Cool-down rate (Peak to 50°C)	less than 6°C/second
Time from 30°C to Peak temperature	no greater than 300 seconds

Chip-mount air reflow profile

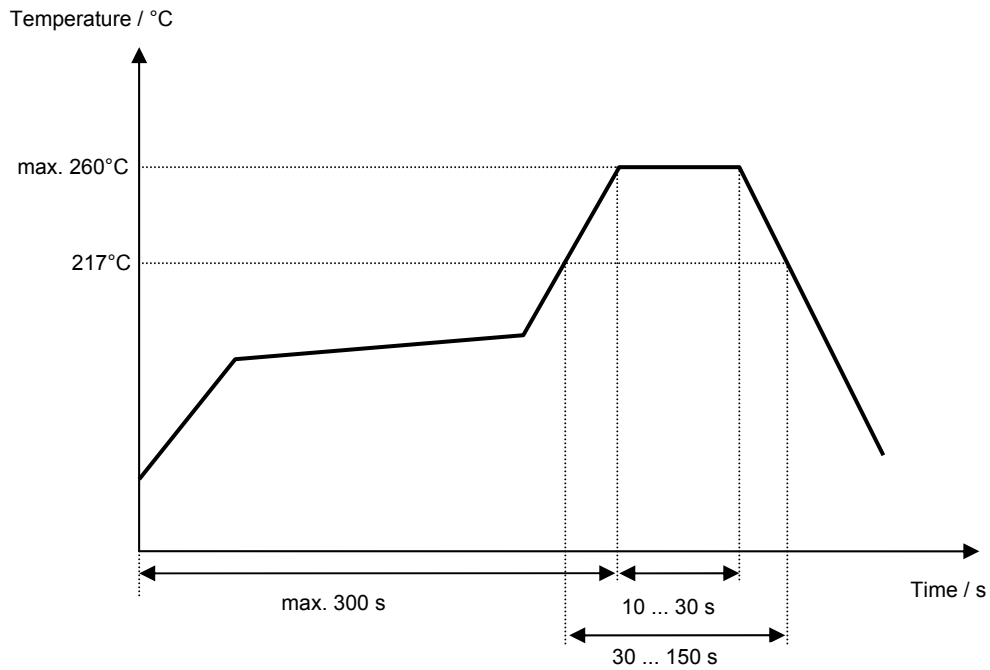

Tele Filter GmbH
 Potsdamer Straße 18
 D 14 513 TELTOW / Germany
 Tel: (+49) 3328 4784-0 / Fax: (+49) 3328 4784-30
 E-Mail: tft@telefilter.com

VI TELEFILTER reserves the right to make changes to the product(s) and/or information contained herein without notice. No liability is assumed as a result of their use or application. No rights under any patent accompany the sale of any such product(s) or information.

VI TELEFILTER**Filter specification****TFS 76C****5/5****History**

Version	Reason of Changes	Name	Date
1.0	- generated specification according to customer requirement	Chilla	09.07.2004
1.1	- typical values, filter characteristic, matching configuration and terminating impedance added	Pfeiffer	25.08.2004
1.2	- centre frequency changed to 76,100 MHz	Pfeiffer	31.08.2004
1.3	- terminating impedance fixed - insertion loss limit changed to 19 dB - typical values corrected - air reflow temperature conditions modified	Pfeiffer	04.01.2005

Tele Filter GmbH
Potsdamer Straße 18
D 14 513 TELTOW / Germany
Tel: (+49) 3328 4784-0 / Fax: (+49) 3328 4784-30
E-Mail: tft@telefilter.com

VI TELEFILTER reserves the right to make changes to the product(s) and/or information contained herein without notice. No liability is assumed as a result of their use or application. No rights under any patent accompany the sale of any such product(s) or information.