

General Description

The AO4916 uses advanced trench technology to provide excellent $R_{DS(ON)}$ and low gate charge. The two MOSFETs make a compact and efficient switch and synchronous rectifier combination for use in DC-DC converters. A Schottky diode is co-packaged in parallel with the synchronous MOSFET to boost efficiency further. AO4916L (Green Product) is offered in a lead-free package.

Features

- V_{DS} (V) = 30V
- I_D = 8.5A
- $R_{DS(ON)} < 17m\Omega$ ($V_{GS} = 10V$)
- $R_{DS(ON)} < 27m\Omega$ ($V_{GS} = 4.5V$)

SCHOTTKY

V_{DS} (V) = 30V, I_F = 3A, $V_F=0.5V@1A$

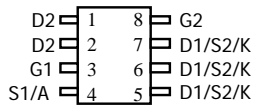

SOIC-8

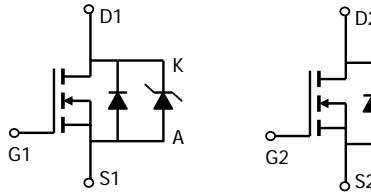

Absolute Maximum Ratings $T_A=25^\circ\text{C}$ unless otherwise noted

Parameter	Symbol	MOSFET	Schottky	Units
Drain-Source Voltage	V_{DS}	30		V
Gate-Source Voltage	V_{GS}	± 20		V
Continuous Drain Current ^A	I_D	$T_A=25^\circ\text{C}$	8.5	A
		$T_A=70^\circ\text{C}$	6.6	
Pulsed Drain Current ^B	I_{DM}	40		
Schottky reverse voltage	V_{KA}		30	V
Continuous Forward Current ^A	I_F	$T_A=25^\circ\text{C}$	3	A
		$T_A=70^\circ\text{C}$	2	
Pulsed Forward Current ^B	I_{FM}		40	
Power Dissipation	P_D	$T_A=25^\circ\text{C}$	2	W
		$T_A=70^\circ\text{C}$	1.28	
Junction and Storage Temperature Range	T_J, T_{STG}	-55 to 150	-55 to 150	$^\circ\text{C}$

Parameter: Thermal Characteristics MOSFET		Symbol	Typ	Max	Units
Maximum Junction-to-Ambient ^A	$t \leq 10s$	$R_{\theta JA}$	48	62.5	$^\circ\text{C/W}$
Maximum Junction-to-Ambient ^A	Steady-State		74	110	
Maximum Junction-to-Lead ^C	Steady-State	$R_{\theta JL}$	35	40	
Thermal Characteristics Schottky					
Maximum Junction-to-Ambient ^A	$t \leq 10s$	$R_{\theta JA}$	47.5	62.5	$^\circ\text{C/W}$
Maximum Junction-to-Ambient ^A	Steady-State		71	110	
Maximum Junction-to-Lead ^C	Steady-State	$R_{\theta JL}$	32	40	

Electrical Characteristics ($T_J=25^\circ\text{C}$ unless otherwise noted)

Symbol	Parameter	Conditions	Min	Typ	Max	Units
STATIC PARAMETERS						
BV_{DSS}	Drain-Source Breakdown Voltage	$I_D=250\mu\text{A}$, $V_{GS}=0\text{V}$	30			V
I_{DSS}	Zero Gate Voltage Drain Current	$V_{DS}=24\text{V}$, $V_{GS}=0\text{V}$ $T_J=55^\circ\text{C}$		0.005	1	μA
I_{GSS}	Gate-Body leakage current	$V_{DS}=0\text{V}$, $V_{GS}=\pm 20\text{V}$			100	nA
$V_{GS(th)}$	Gate Threshold Voltage	$V_{DS}=V_{GS}$, $I_D=250\mu\text{A}$	1	1.8	3	V
$I_{D(ON)}$	On state drain current	$V_{GS}=10\text{V}$, $V_{DS}=5\text{V}$	40			A
$R_{DS(ON)}$	Static Drain-Source On-Resistance	$V_{GS}=10\text{V}$, $I_D=8.5\text{A}$ $T_J=125^\circ\text{C}$		14	17	$\text{m}\Omega$
		$V_{GS}=4.5\text{V}$, $I_D=6\text{A}$		20	25	$\text{m}\Omega$
g_{FS}	Forward Transconductance	$V_{DS}=5\text{V}$, $I_D=8.5\text{A}$		23		S
V_{SD}	Diode Forward Voltage	$I_S=1\text{A}$, $V_{GS}=0\text{V}$		0.76	1	V
I_S	Maximum Body-Diode Continuous Current				3	A
DYNAMIC PARAMETERS						
C_{iss}	Input Capacitance			1040	1250	pF
C_{oss}	Output Capacitance	$V_{GS}=0\text{V}$, $V_{DS}=15\text{V}$, $f=1\text{MHz}$		180		pF
C_{rss}	Reverse Transfer Capacitance			110		pF
R_g	Gate resistance	$V_{GS}=0\text{V}$, $V_{DS}=0\text{V}$, $f=1\text{MHz}$	0.35	0.7	0.85	Ω
SWITCHING PARAMETERS						
$Q_g(10\text{V})$	Total Gate Charge			19.2	24	nC
$Q_g(4.5\text{V})$	Total Gate Charge	$V_{GS}=10\text{V}$, $V_{DS}=15\text{V}$, $I_D=8.5\text{A}$		9.36	12	nC
Q_{gs}	Gate Source Charge			2.6		nC
Q_{gd}	Gate Drain Charge			4.2		nC
$t_{D(on)}$	Turn-On DelayTime			5.2	7.5	ns
t_r	Turn-On Rise Time	$V_{GS}=10\text{V}$, $V_{DS}=15\text{V}$, $R_L=1.8\Omega$, $R_{GEN}=3\Omega$		4.4	6.5	ns
$t_{D(off)}$	Turn-Off DelayTime			17.3	25	ns
t_f	Turn-Off Fall Time			3.3	5	ns
t_{rr}	Body Diode Reverse Recovery Time	$I_F=8.5\text{A}$, $dI/dt=100\text{A}/\mu\text{s}$		16.7	21	ns
Q_{rr}	Body Diode Reverse Recovery Charge	$I_F=8.5\text{A}$, $dI/dt=100\text{A}/\mu\text{s}$		9.3	11	nC
SCHOTTKY PARAMETERS						
V_F	Forward Voltage Drop	$I_F=1.0\text{A}$		0.45	0.5	V
I_{rm}	Maximum reverse leakage current	$V_R=30\text{V}$		0.007	0.05	mA
		$V_R=30\text{V}$, $T_J=125^\circ\text{C}$		3.2	10	
		$V_R=30\text{V}$, $T_J=150^\circ\text{C}$		12	20	
C_T	Junction Capacitance	$V_R=15\text{V}$		37		pF

A: The value of $R_{\theta JA}$ is measured with the device mounted on 1 in² FR-4 board with 2oz. Copper, in a still air environment with $T_A=25^\circ\text{C}$. The value in any a given application depends on the user's specific board design. The current rating is based on the $t \leq 10\text{s}$ thermal resistance rating.

B: Repetitive rating, pulse width limited by junction temperature.

C: The $R_{\theta JA}$ is the sum of the thermal impedance from junction to lead $R_{\theta JL}$ and lead to ambient.

D: The static characteristics in Figures 1 to 6 are obtained using 80 μs pulses, duty cycle 0.5% max.

E: These tests are performed with the device mounted on 1 in² FR-4 board with 2oz. Copper, in a still air environment with $T_A=25^\circ\text{C}$. The SOA curve provides a single pulse rating.

THIS PRODUCT HAS BEEN DESIGNED AND QUALIFIED FOR THE CONSUMER MARKET. APPLICATIONS OR USES AS CRITICAL COMPONENTS IN LIFE SUPPORT DEVICES OR SYSTEMS ARE NOT AUTHORIZED. AOS DOES NOT ASSUME ANY LIABILITY ARISING OUT OF SUCH APPLICATIONS OR USES OF ITS PRODUCTS. AOS RESERVES THE RIGHT TO IMPROVE PRODUCT DESIGN, FUNCTIONS AND RELIABILITY WITHOUT NOTICE.

TYPICAL ELECTRICAL AND THERMAL CHARACTERISTICS

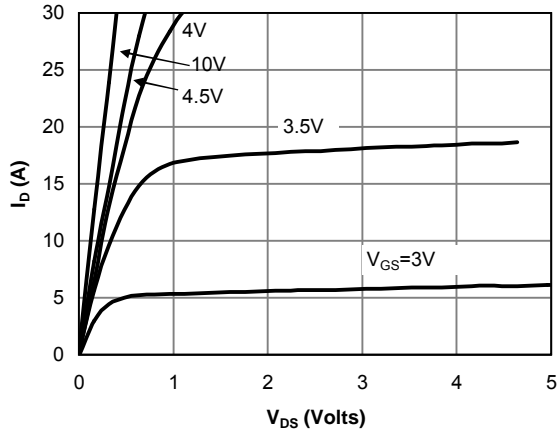

Fig 1: On-Region Characteristics

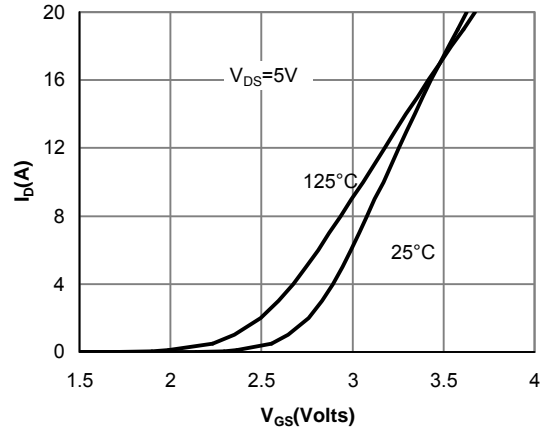

Figure 2: Transfer Characteristics

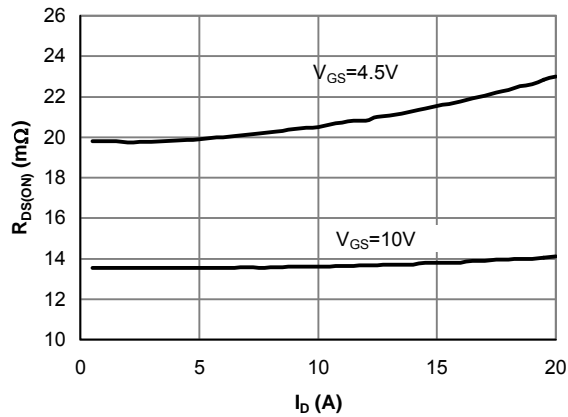

Figure 3: On-Resistance vs. Drain Current and Gate Voltage

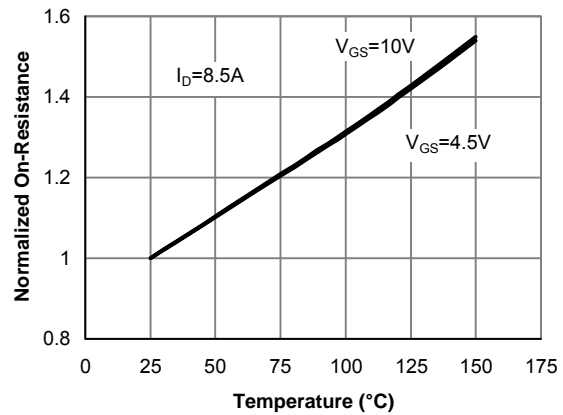

Figure 4: On-Resistance vs. Junction Temperature

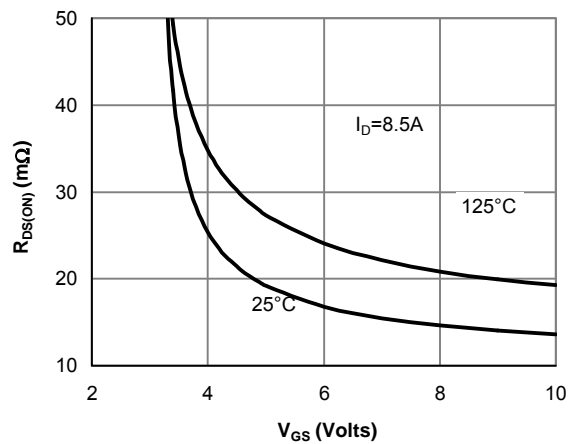

Figure 5: On-Resistance vs. Gate-Source Voltage

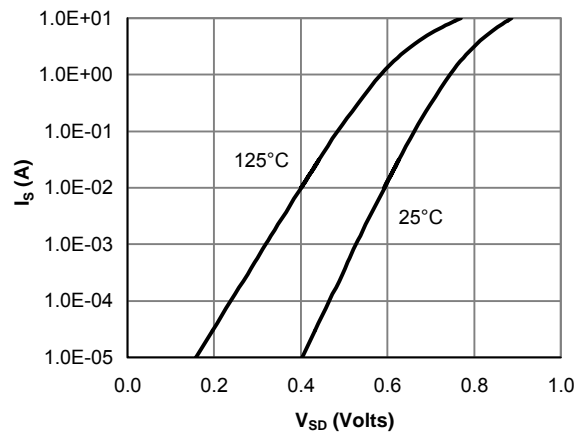

Figure 6: Body-Diode Characteristics

TYPICAL ELECTRICAL AND THERMAL CHARACTERISTICS

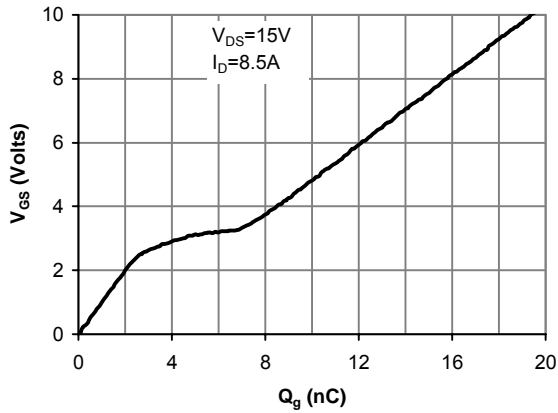

Figure 7: Gate-Charge Characteristics

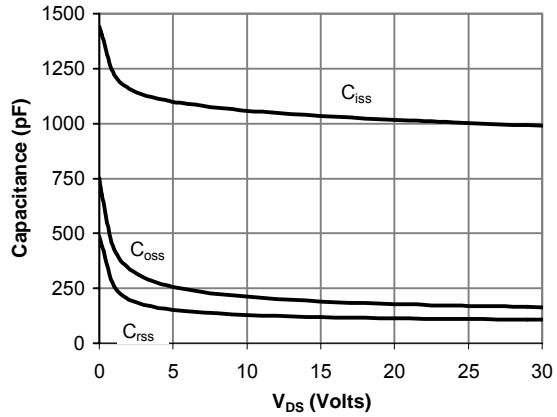

Figure 8: Capacitance Characteristics

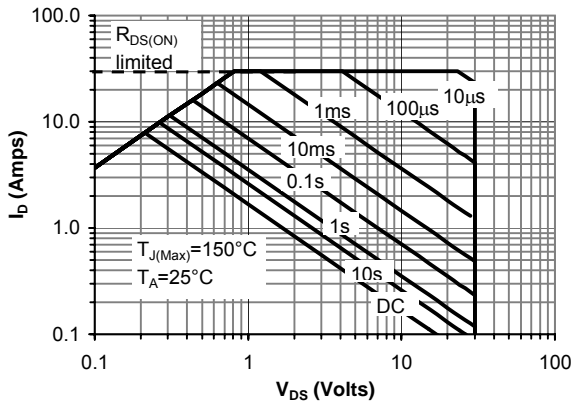

Figure 9: Maximum Forward Biased Safe Operating Area (Note E)

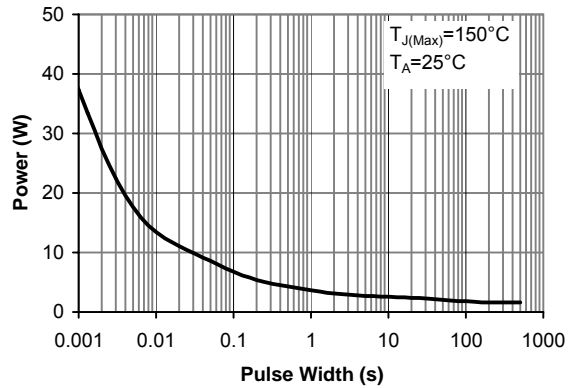

Figure 10: Single Pulse Power Rating Junction-to-Ambient (Note E)

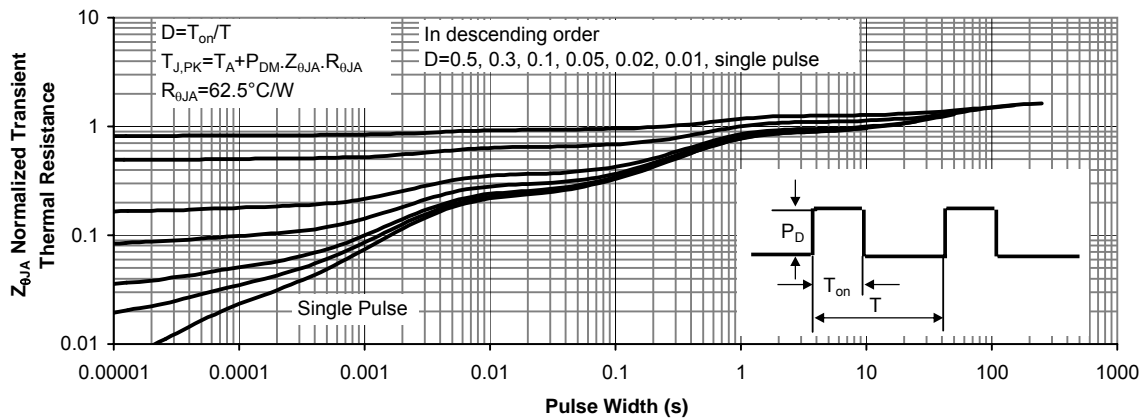
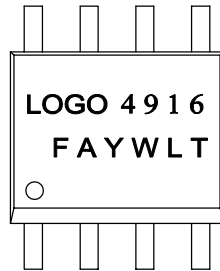
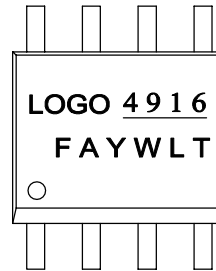

Figure 11: Normalized Maximum Transient Thermal Impedance

SO-8 PACKAGE MARKING DESCRIPTION



Standard product



Green product

NOTE:

LOGO - AOS LOGO
 4916 - PART NUMBER CODE.
 F&A - FOUNDRY AND ASSEMBLY LOCATION
 Y - YEAR CODE
 W - WEEK CODE.
 L T - ASSEMBLY LOT CODE

PART NO.	DESCRIPTION	CODE
AO4916	Standard product	4916
AO4916L	Green product	<u>4916</u>

SO-8L PACKAGE OUTLINE

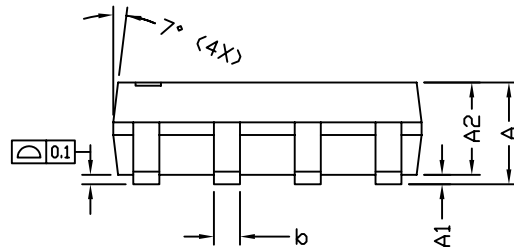
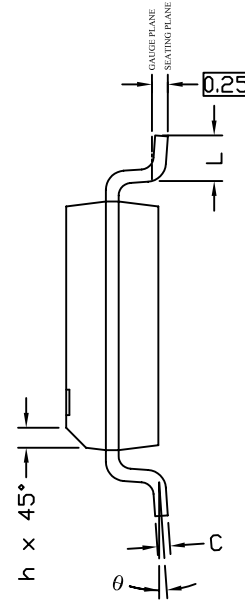
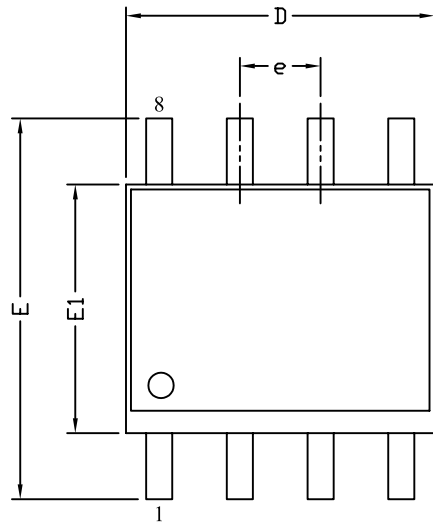

RECOMMENDED LAND PATTERN

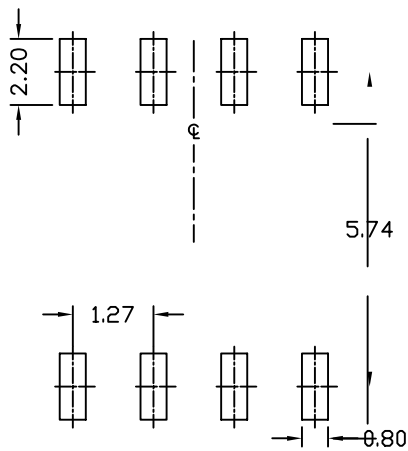

UNIT: mm

SYMBOLS	DIMENSIONS IN MILLIMETERS			DIMENSIONS IN INCHES		
	MIN	NOM	MAX	MIN	NOM	MAX
A	1.35	1.65	1.75	0.053	0.065	0.069
A1	0.10	—	0.25	0.004	—	0.010
A2	1.25	1.50	1.65	0.049	0.059	0.065
b	0.31	—	0.51	0.012	—	0.020
c	0.17	—	0.25	0.007	—	0.010
D	4.80	4.90	5.00	0.189	0.193	0.197
E1	3.80	3.90	4.00	0.150	0.154	0.157
e	1.27 BSC			0.050 BSC		
E	5.80	6.00	6.20	0.228	0.236	0.244
h	0.25	—	0.50	0.010	—	0.020
L	0.40	—	1.27	0.016	—	0.050
θ	0°	—	8°	0°	—	8°

NOTE

1. ALL DIMENSIONS ARE IN MILLIMETERS.
2. DIMENSIONS ARE INCLUSIVE OF PLATING.
3. PACKAGE BODY SIZES EXCLUDE MOLD FLASH AND GATE BURRS.
4. DIMENSION L IS MEASURED IN GAUGE PLANE.
5. CONTROLLING DIMENSION IS MILLIMETER. CONVERTED INCH DIMENSIONS ARE NOT NECESSARILY EXACT.

SO-8 Carrier Tape

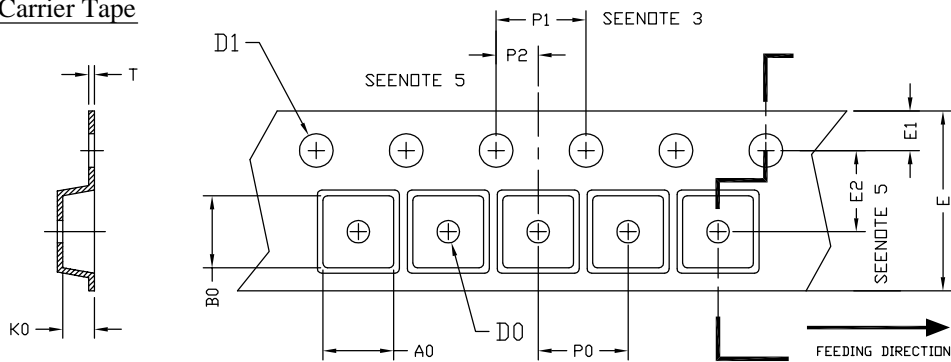

UNIT: MM

PACKAGE	A0	B0	K0	D0	D1	E	E1	E2	P0	P1	P2	T
SD-8 (12 mm)	6.40 ±0.10	5.20 ±0.10	2.10 ±0.10	1.60 ±0.10	1.50 +0.10	12.00 ±0.30	1.75 ±0.10	5.50 ±0.05	8.00 ±0.10	4.00 ±0.10	2.00 ±0.05	0.25 ±0.05

SO-8 Reel

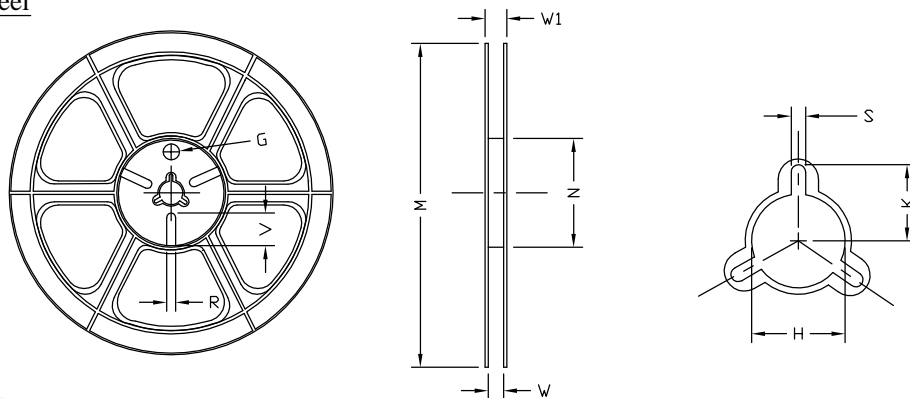

UNIT: MM

TAPE SIZE	REEL SIZE	M	N	W	W1	H	K	S	G	R	V
12 mm	ø330	ø330.00 ±0.50	ø97.00 ±0.10	13.00 ±0.30	17.40 ±1.00	ø13.00 +0.50 -0.20	10.60	2.00 ±0.50	---	---	---

SO-8 Tape

Leader / Trailer & Orientation

