

FEATURES

- Double Side Cooling
- High Surge Capability

APPLICATIONS

- High Power Drives
- High Voltage Power Supplies
- Static Switches

VOLTAGE RATINGS

| Part and Ordering Number | Repetitive Peak Voltages V_{DRM} and V_{RRM} V | Conditions |
|--------------------------|---|---|
| DCR1430X34 | 3400 | $T_{vj} = -40^{\circ}\text{C}$ to 125°C , $I_{DRM} = I_{RRM} = 150\text{mA}$, $V_{DRM}, V_{RRM} t_p = 10\text{ms}$, $V_{DSM} \& V_{RSM} =$ $V_{DRM} \& V_{RRM} + 100\text{V}$ respectively |
| DCR1430X32 | 3200 | |
| DCR1430X30 | 3000 | |
| DCR1430X28 | 2800 | |
| DCR1430X26 | 2600 | |
| DCR1430X24 | 2400 | |

Lower voltage grades available.

ORDERING INFORMATION

When ordering, select the required part number shown in the Voltage Ratings selection table.

For example:

DCR1430X34

Note: Please use the complete part number when ordering and quote this number in any future correspondence relating to your order.

KEY PARAMETERS

| | |
|-------------|--|
| V_{DRM} | 3400 V |
| $I_{T(AV)}$ | 1430 A |
| I_{TSM} | 19200 A |
| dV/dt^* | 1000 V/μs |
| dI/dt | 200 A/μs |

* Higher dV/dt selections available

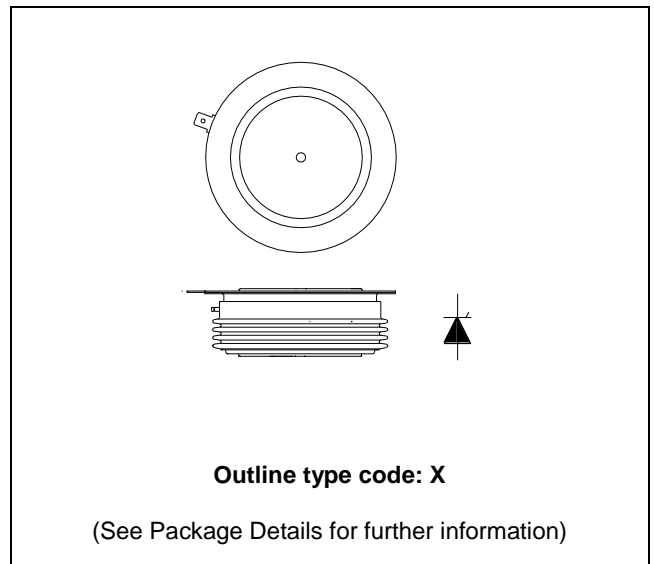

Fig. 1 Package outline

CURRENT RATINGS

T_{case} = 60°C unless stated otherwise

| Symbol | Parameter | Test Conditions | Max. | Units |
|---------------------------|--------------------------------------|--------------------------|------|-------|
| Double Side Cooled | | | | |
| I _{T(AV)} | Mean on-state current | Half wave resistive load | 1430 | A |
| I _{T(RMS)} | RMS value | - | 2250 | A |
| I _T | Continuous (direct) on-state current | - | 2020 | A |

SURGE RATINGS

| Symbol | Parameter | Test Conditions | Max. | Units |
|------------------|---|---|------|-------------------|
| I _{TSM} | Surge (non-repetitive) on-state current | 10ms half sine, T _{case} = 125°C | 19.2 | kA |
| I ² t | I ² t for fusing | V _R = 0 | 1.84 | MA ² s |

THERMAL AND MECHANICAL RATINGS

| Symbol | Parameter | Test Conditions | Min. | Max. | Units |
|----------------------|---------------------------------------|--|------|-------|-------|
| R _{th(j-c)} | Thermal resistance – junction to case | Double side cooled | - | 0.018 | °C/W |
| R _{th(c-h)} | Thermal resistance – case to heatsink | Double side cooled | - | 0.005 | °C/W |
| T _{vj} | Virtual junction temperature | Blocking V _{DRM} / V _{RRM} | - | 125 | °C |
| T _{stg} | Storage temperature range | | -40 | 140 | °C |
| F _m | Clamping force | | 26 | 34 | kN |

DYNAMIC CHARACTERISTICS

| Symbol | Parameter | Test Conditions | Min. | Max. | Units | |
|-------------------|---|--|-----------------|------|------------|------------|
| I_{RRM}/I_{DRM} | Peak reverse and off-state current | At V_{RRM}/V_{DRM} , $T_{case} = 125^{\circ}C$ | - | 150 | mA | |
| dV/dt | Max. linear rate of rise of off-state voltage | To 67% V_{DRM} , $T_j = 125^{\circ}C$, gate open | 1000 | - | V/ μs | |
| di/dt | Rate of rise of on-state current | From 67% V_{DRM} to 2000A Gate source 30V, 10 Ω , $t_r < 0.5\mu s$, $T_j = 125^{\circ}C$ | Repetitive 50Hz | - | 200 | A/ μs |
| | | | Non-repetitive | - | 1000 | A/ μs |
| V_T | On-state voltage | $I_T = 3000A$, $T_{case} = 125^{\circ}C$ | | 2.11 | V | |
| $V_{T(TO)}$ | Threshold voltage | $T_{case} = 125^{\circ}C$ | - | 1.06 | V | |
| r_T | On-state slope resistance | $T_{case} = 125^{\circ}C$ | - | 0.35 | m Ω | |
| t_{gd} | Delay time | $V_D = 67\% V_{DRM}$, gate source 30V, 10 Ω $t_r = 0.5\mu s$, $T_j = 25^{\circ}C$ | - | 3.0 | μs | |
| I_L | Latching current | $T_j = 25^{\circ}C$, | - | 1 | A | |
| I_H | Holding current | $T_j = 25^{\circ}C$, | - | 200 | mA | |

GATE TRIGGER CHARACTERISTICS AND RATINGS

| Symbol | Parameter | Test Conditions | Max. | Units |
|----------|--------------------------|--|------|-------|
| V_{GT} | Gate trigger voltage | $V_{DRM} = 5V$, $T_{case} = 25^{\circ}C$ | 3 | V |
| V_{GD} | Gate non-trigger voltage | At 40% V_{DRM} , $T_{case} = 125^{\circ}C$ | TBD | V |
| I_{GT} | Gate trigger current | $V_{DRM} = 5V$, $T_{case} = 25^{\circ}C$ | 300 | mA |
| I_{GD} | Gate non-trigger current | At 40% V_{DRM} , $T_{case} = 125^{\circ}C$ | TBD | mA |

CURVES

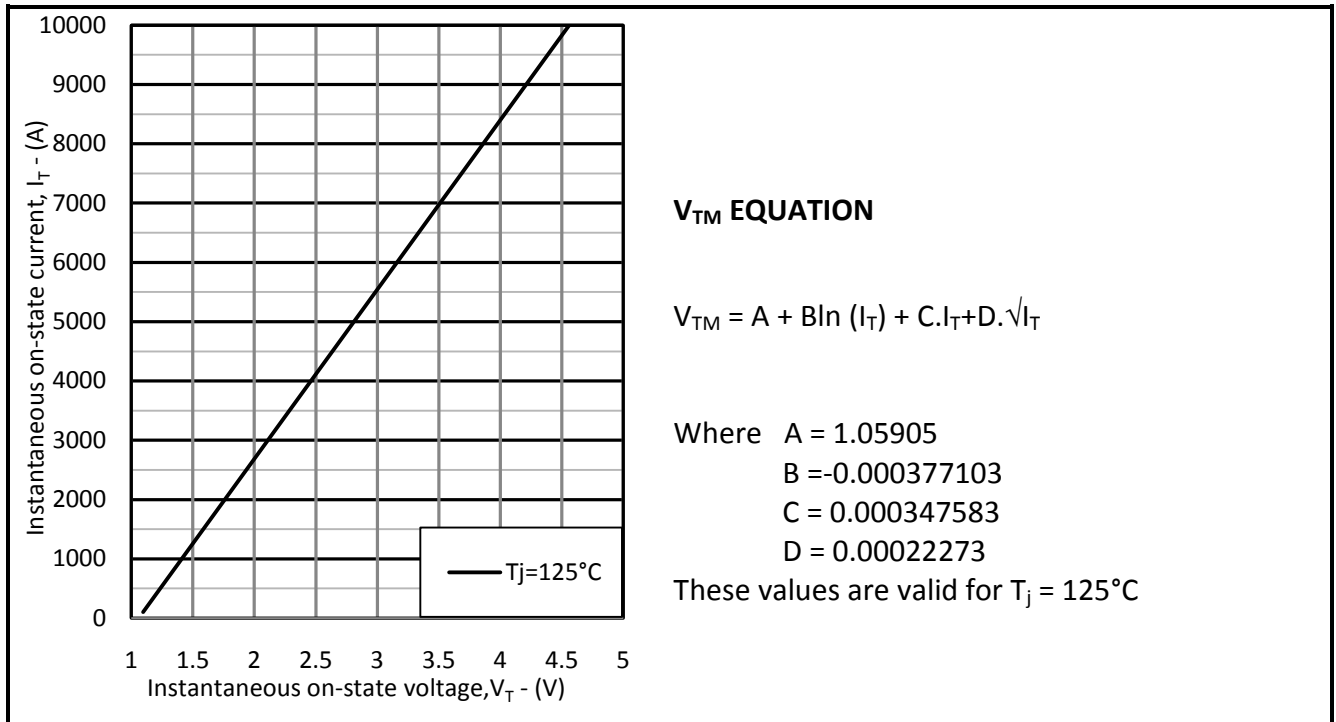

Fig.2 Maximum & minimum on-state characteristics

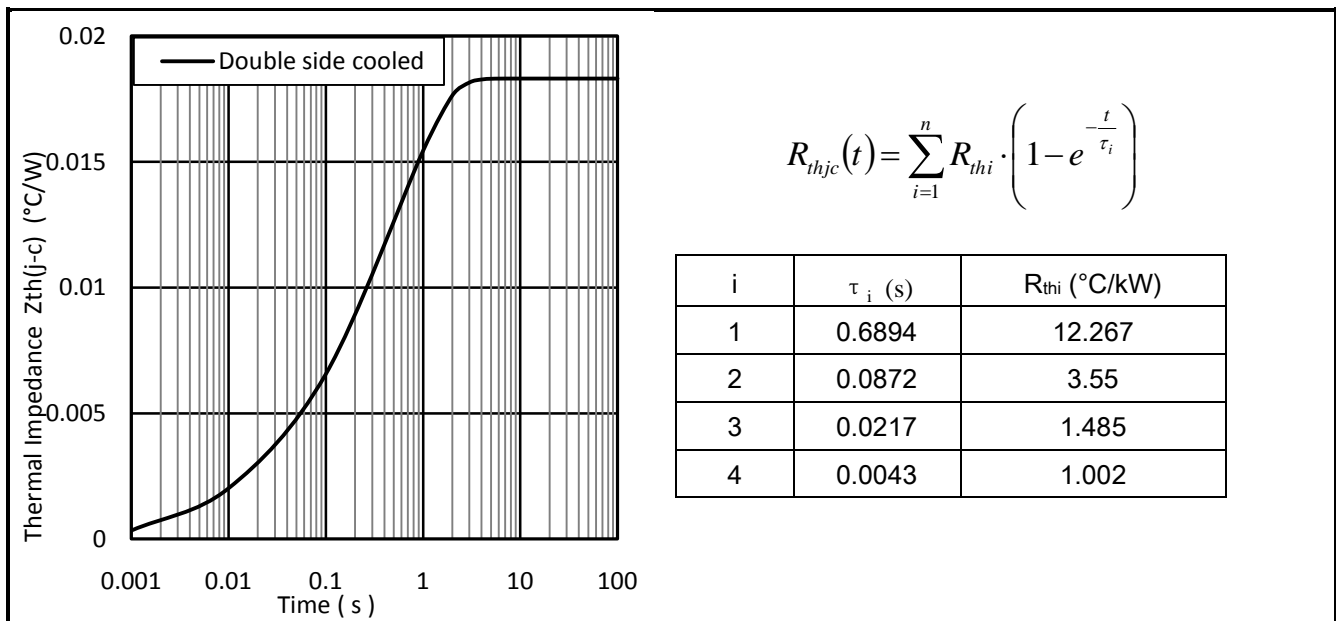

Fig.3 Maximum (limit) transient thermal impedance – junction to case (°C/W)

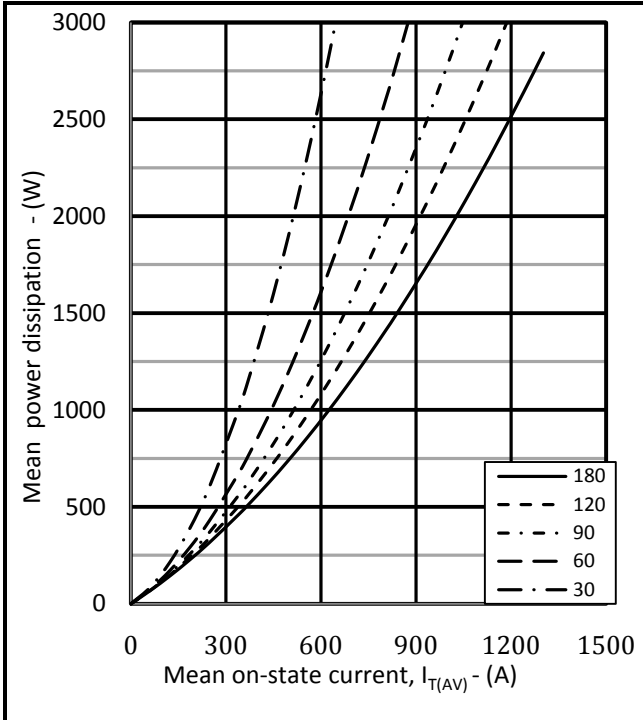

Fig.4 On-state power dissipation – sine wave

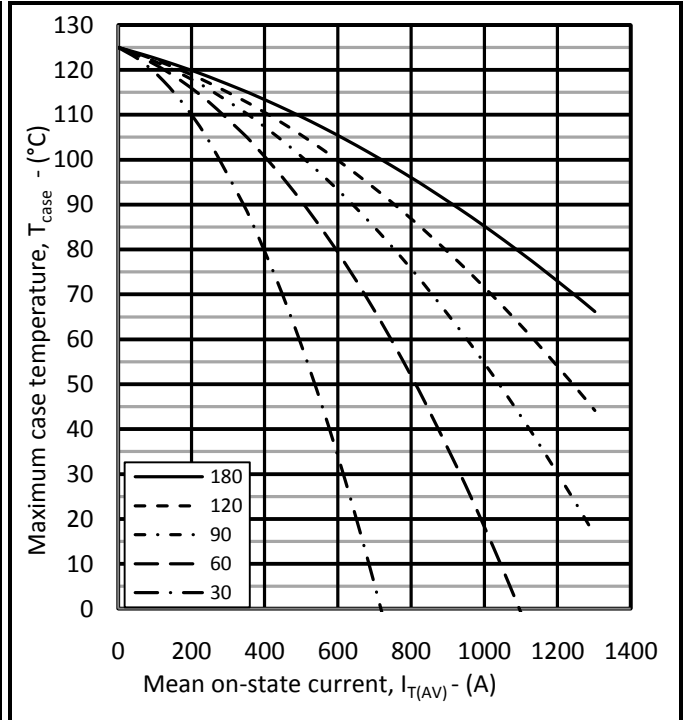

Fig.5 Maximum permissible case temperature, double side cooled – sine wave

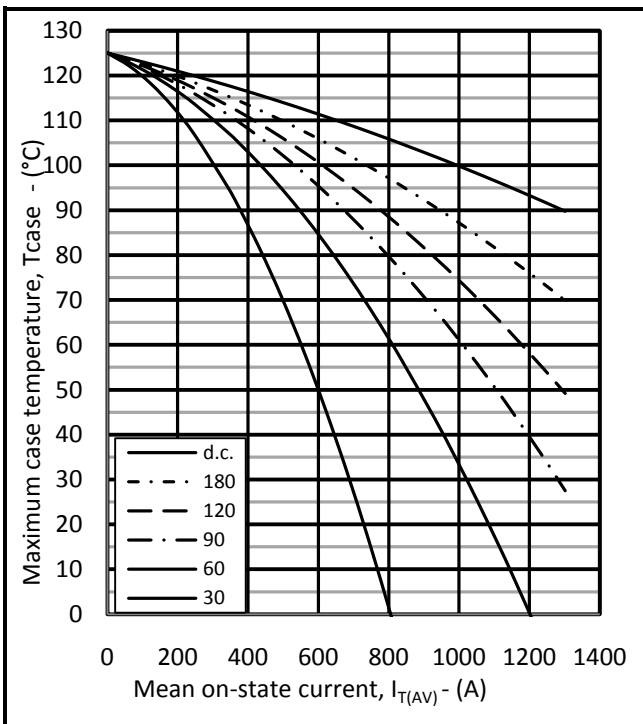

Fig.6 Maximum permissible case temperature, double side cooled – rectangular wave

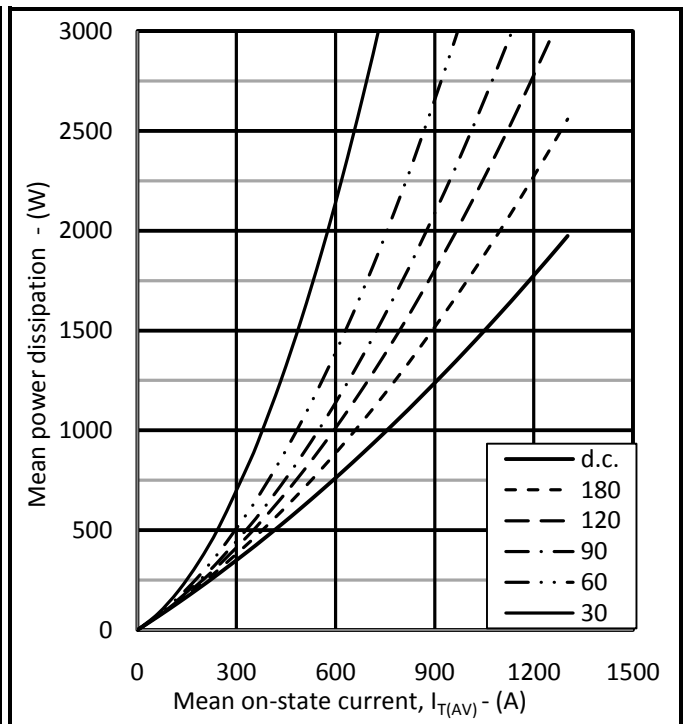

Fig.7 On-state power dissipation – rectangular wave

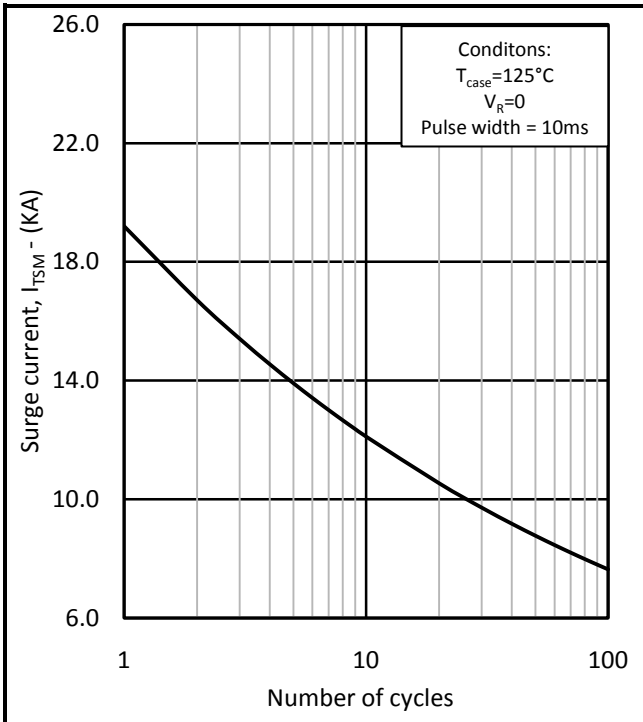

Fig.8 Multi-cycle surge current

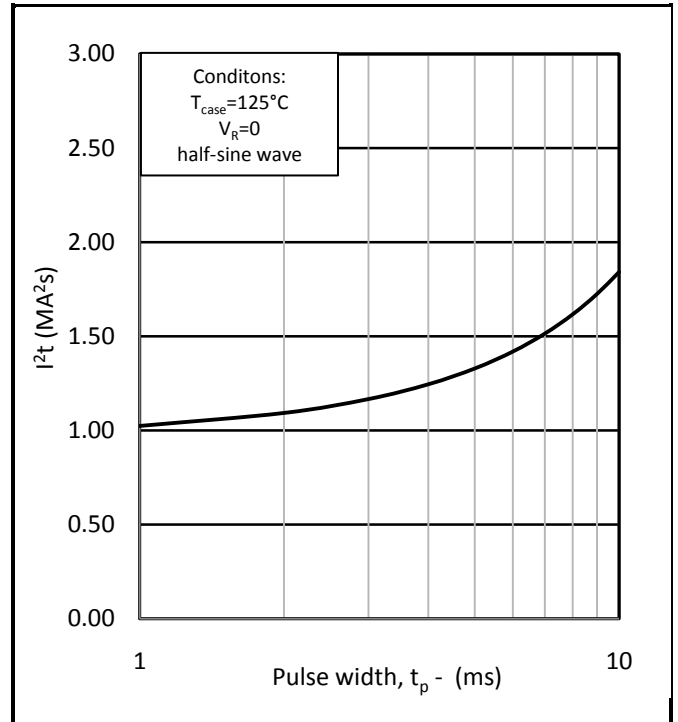

Fig.9 Single-cycle I^2t

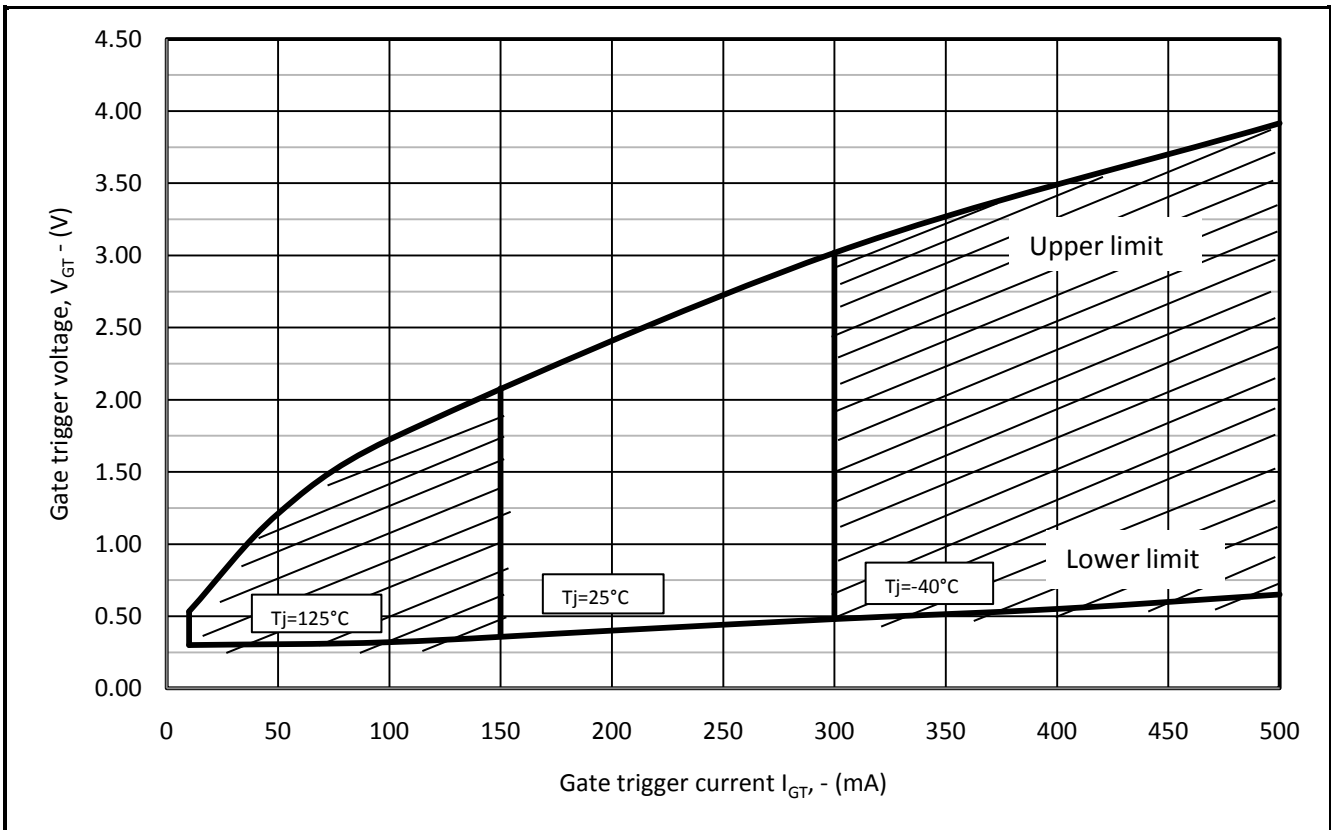

Fig.10 Gate characteristics

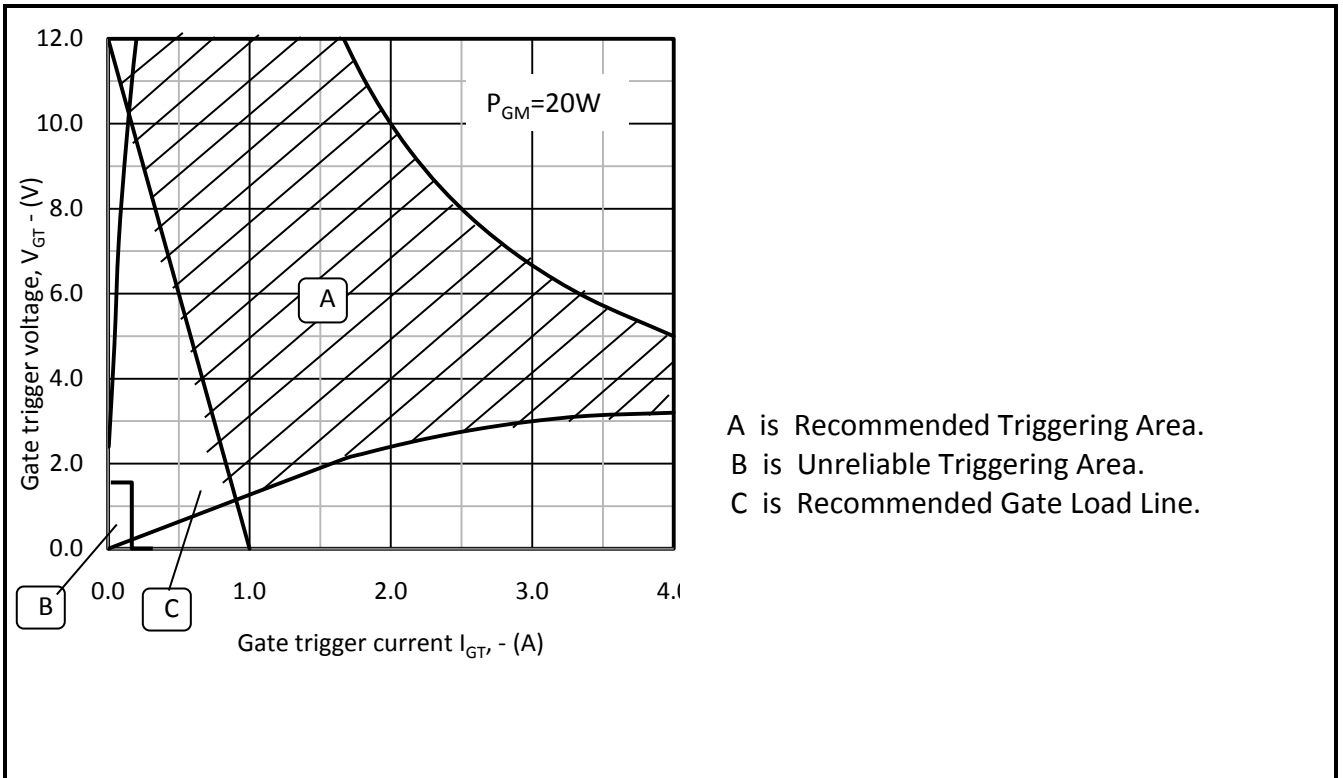

Fig.11 Gate characteristics

PACKAGE DETAILS

For further package information, please contact Customer Services. All dimensions in mm, unless stated otherwise. DO NOT SCALE.

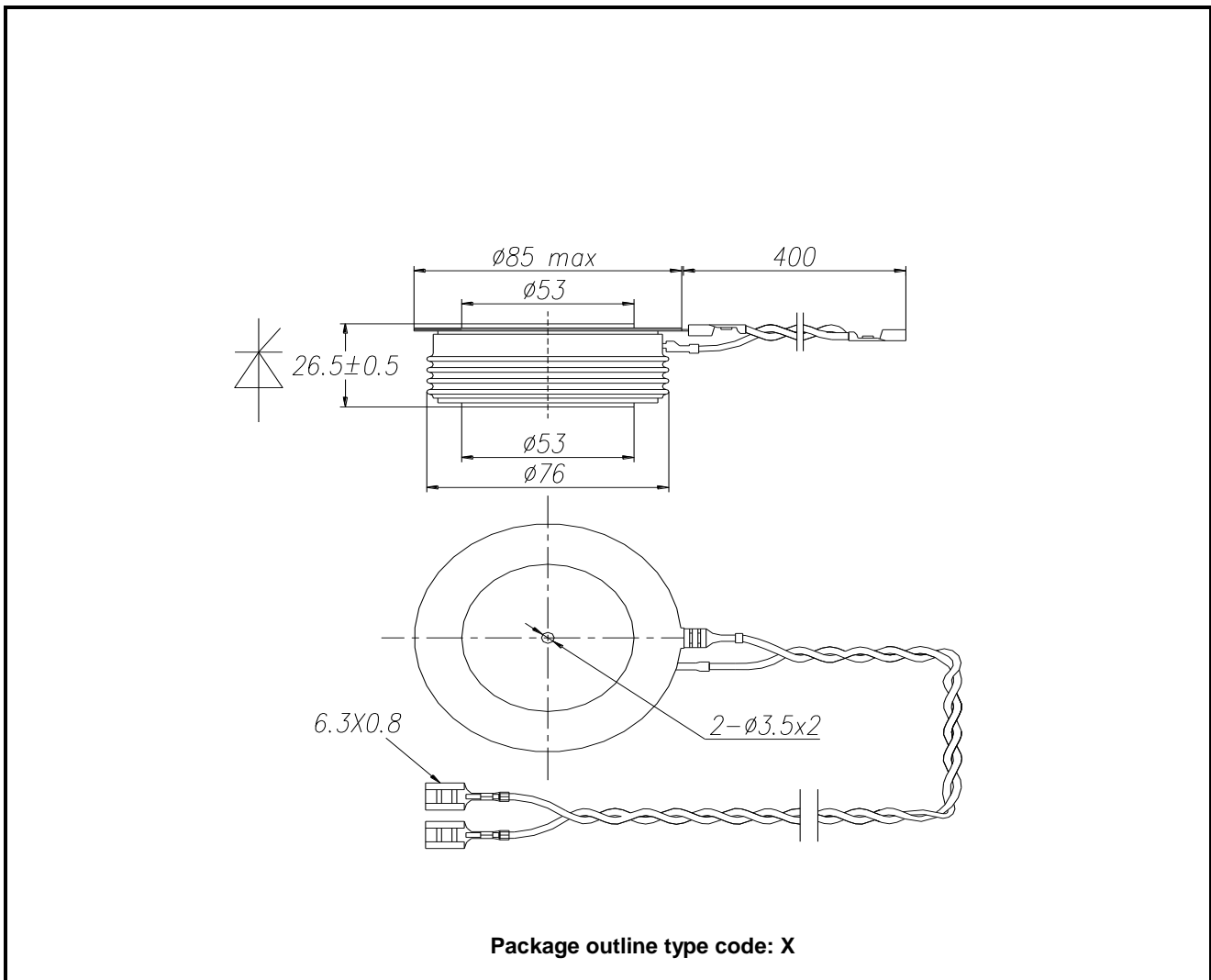

Fig.12 Package outline

IMPORTANT INFORMATION:

This publication is provided for information only and not for resale.

The products and information in this publication are intended for use by appropriately trained technical personnel.

Due to the diversity of product applications, the information contained herein is provided as a general guide only and does not constitute any guarantee of suitability for use in a specific application. The user must evaluate the suitability of the product and the completeness of the product data for the application. The user is responsible for product selection and ensuring all safety and any warning requirements are met. Should additional product information be needed please contact Customer Service.

Although we have endeavoured to carefully compile the information in this publication it may contain inaccuracies or typographical errors. The information is provided without any warranty or guarantee of any kind.

This publication is an uncontrolled document and is subject to change without notice. When referring to it please ensure that it is the most up to date version and has not been superseded.

The products are not intended for use in applications where a failure or malfunction may cause loss of life, injury or damage to property. The user must ensure that appropriate safety precautions are taken to prevent or mitigate the consequences of a product failure or malfunction.

The products must not be touched when operating because there is a danger of electrocution or severe burning. Always use protective safety equipment such as appropriate shields for the product and wear safety glasses. Even when disconnected any electric charge remaining in the product must be discharged and allowed to cool before safe handling using protective gloves.

Extended exposure to conditions outside the product ratings may affect reliability leading to premature product failure. Use outside the product ratings is likely to cause permanent damage to the product. In extreme conditions, as with all semiconductors, this may include potentially hazardous rupture, a large current to flow or high voltage arcing, resulting in fire or explosion. Appropriate application design and safety precautions should always be followed to protect persons and property.

Product Status & Product Ordering:

We annotate datasheets in the top right hand corner of the front page, to indicate product status if it is not yet fully approved for production. The annotations are as follows:-

| | |
|---------------------------------|---|
| Target Information: | This is the most tentative form of information and represents a very preliminary specification. No actual design work on the product has been started. |
| Preliminary Information: | The product design is complete and final characterisation for volume production is in progress. The datasheet represents the product as it is now understood but details may change. |
| No Annotation: | The product has been approved for production and unless otherwise notified by Dynex any product ordered will be supplied to the current version of the data sheet prevailing at the time of our order acknowledgement. |

All products and materials are sold and services provided subject to Dynex's conditions of sale, which are available on request.

Any brand names and product names used in this publication are trademarks, registered trademarks or trade names of their respective owners.

HEADQUARTERS OPERATIONS

DYNEX SEMICONDUCTOR LIMITED
Doddington Road, Lincoln, Lincolnshire, LN6 3LF
United Kingdom.
Phone: +44 (0) 1522 500500
Fax: +44 (0) 1522 500550
Web: <http://www.dynexsemi.com>

CUSTOMER SERVICE

Phone: +44 (0) 1522 502753 / 502901
Fax: +44 (0) 1522 500020
e-mail: power_solutions@dynexsemi.com