

Silicon Controlled Rectifiers

Features

- Repetitive Peak Off-State Voltage:600V
- R.M.S On-State Current ($I_{T(RMS)}=20A$)
- Low On-State Voltage(1.3V(Typ.)@ I_{TM})
- Non-isolaed Type

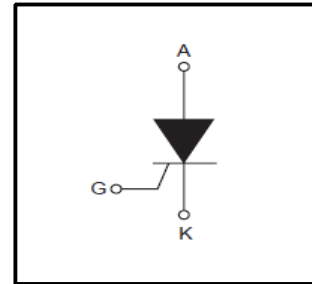

General Description

Standard gate triggering SCR is fully isolated package suitable for the application where requiring high bidirectional blocking voltage capability and also suitable for over voltage protection ,motor control circuit in power tool, inrush current limit circuit and heating control system

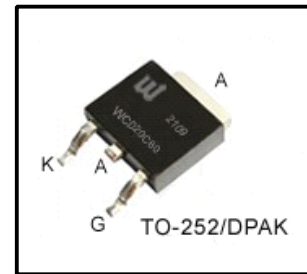

Absolute Maximum Ratings ($T_J= 25^{\circ}C$ unless otherwise specified)

Symbol	Parameter	Condition	Value	Units
V_{DRM}	Repetitive Peak Off-State Voltage		600	V
$I_{T(AV)}$	Average On-State Current	Half Sine Wave: $T_C=102^{\circ}C$	13	A
$I_{T(RMS)}$	R.M.S On-State Current	180°conduction Angle	20	A
I_{TSM}	Surge on-state Current	1/2 Cycle,60Hz,Sine Wave Non-Repetitive	220	A
I^2t	I^2t for Fusing	$t=8.3ms$	242	A^2s
di/dt	Critical rate of rise of on-state current		50	$A/\mu s$
P_{GM}	Forward Peak Gate Power Dissipation		20	W
$P_{G(AV)}$	Forward Average Gate Power Dissipation	Over any 20ms period	1	W
I_{FGM}	Forward Peak Gate Current		5	A
V_{RGM}	Reverse Peak Gate Voltage		5.0	V
T_J	Operating Junction Temperature		-40~125	$^{\circ}C$
T_{STG}	Storage Temperature		-40~150	$^{\circ}C$

Thermal Characteristics

Symbol	Parameter	Value			Units
		Min	Typ	Max	
$R_{\theta Jc}$	Thermal Resistance Junction to Case	-	-	1.1	$^{\circ}C/W$
$R_{\theta JA}$	Thermal Resistance Junction to Ambient	-	-	60	$^{\circ}C/W$

Electrical Characteristics (T_C=25°C, unless otherwise noted)

Symbol	Parameter	Test Conditions	Value			Units
			Min	Typ	Max	
I _{DRM}	Repetitive Peak Off-State Current	V _{AK} =V _{DRM} T _C =25°C	-	-	10	μA
		T _C =125°C	-	-	200	μA
V _{TM}	Peak On-State Voltage (1)	I _{TM} =20A, t _p =380μs	-	1.3	1.6	V
I _{GT}	Gate Trigger Current (2)	V _{AK} =6V(DC), R _L =10Ω T _C =25°C	-	-	15	mA
V _{GT}	Gate Trigger Voltage (2)	V _D =6V(DC), R _L =10Ω T _C =25°C	-	-	1.5	V
V _{GD}	Non-Trigger Gate Voltage (1)	V _{AK} =12V, R _L =100Ω T _C =125°C	0.2	-	-	V
dv/dt	Critical Rate of Rise Off-State Voltage	Linear slope up to V _D =67% V _{DRM} , gate open T _J =125°C	200	-	-	V/μs
I _H	Holding Current	I _T =100mA, Gate Open T _C =25°C	-	-	20	mA

***Notes:**

1 Pulse Width ≤1.0ms, Duty cycle ≤1%

2 R_{GK} Current is not Included in measurement.

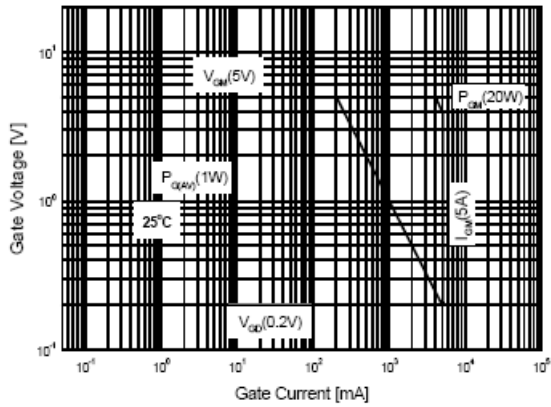

Fig.1 Gate Characteristics

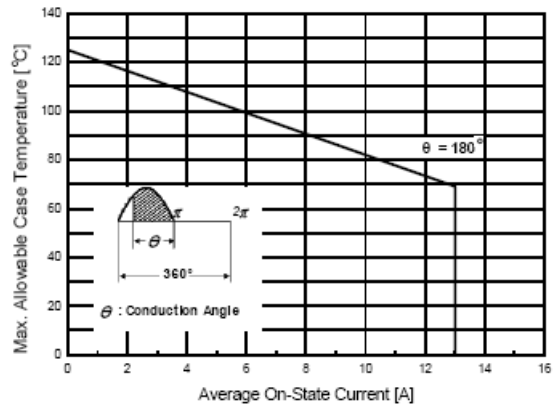

Fig.2 Maximum Case Temperature

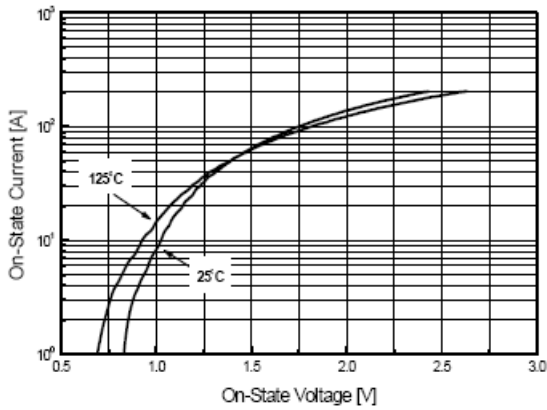

Fig.3 Typical Forward Voltage

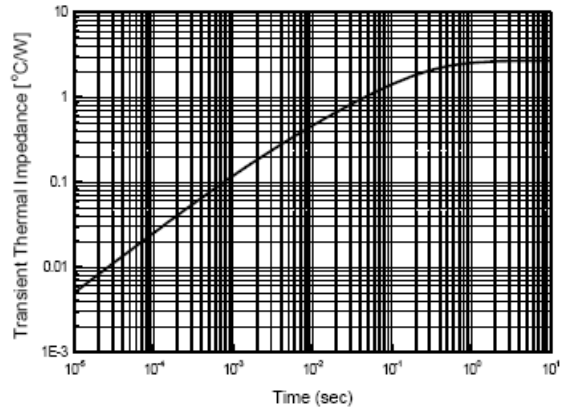

Fig.4 Thermal Response

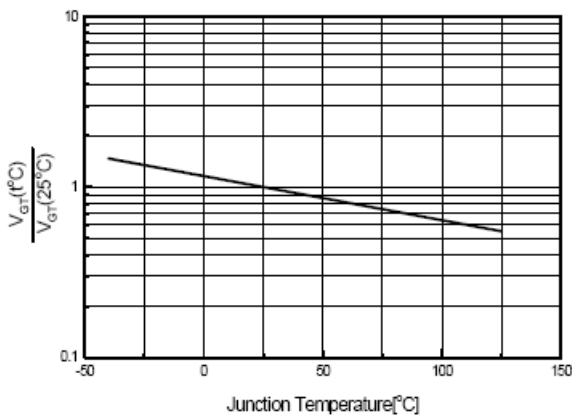

Fig.5 Typical Gate Trigger Voltage vs. Junction Temperature

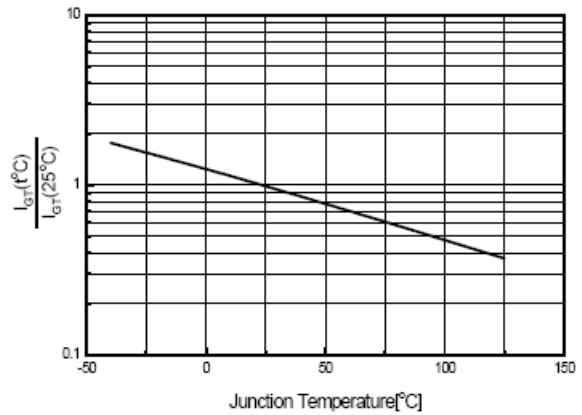

Fig.6 Typical Gate Trigger current vs. Junction Temperature

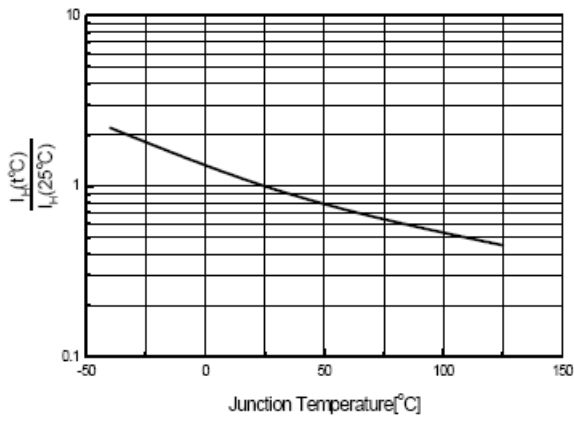

Fig.7 Typical Holding Current

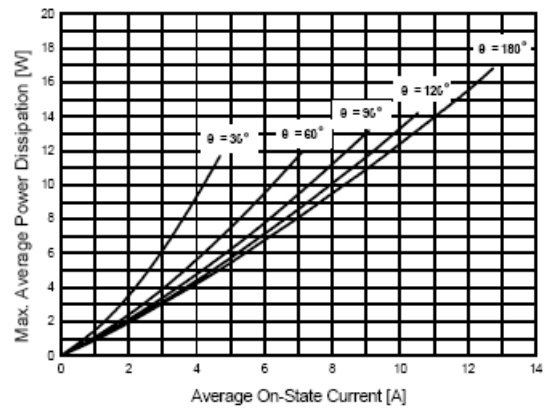

Fig.8 Power Dissipation

TO-252 Package Dimension

Unit: mm

