

WESTCODE

SEMICONDUCTORS

Thyristor Modules

Thyristor/Diode Modules

$$I_{TRMS} = 2 \times 80 \text{ A}$$

$$I_{TAVM} = 2 \times 51 \text{ A}$$

$$V_{RRM} = 800 - 1800 \text{ V}$$

V_{RSM}	V_{RRM}	Type	
V_{DSM}	V_{DRM}		
V	V		
900	800	WPT 44-08	WPH 44-08
1300	1200	WPT 44-12	WPH 44-12
1500	1400	WPT 44-14	WPH 44-14
1700	1600	WPT 44-16	WPH 44-16
1900	1800	WPT 44-18	WPH 44-18

Symbol	Test Conditions	Maximum Ratings	
I_{TRMS}, I_{FRMS} I_{TAVM}, I_{FAVM}	$T_{VJ} = T_{VJM}$	80	A
	$T_C = 83^\circ\text{C}; 180^\circ \text{ sine}$	51	A
	$T_C = 85^\circ\text{C}; 180^\circ \text{ sine}$	49	A
I_{TSM}, I_{FSM}	$T_{VJ} = 45^\circ\text{C};$ $V_R = 0$	t = 10 ms (50 Hz), sine	1150 A
		t = 8.3 ms (60 Hz), sine	1230 A
	$T_{VJ} = T_{VJM}$ $V_R = 0$	t = 10 ms (50 Hz), sine	1000 A
		t = 8.3 ms (60 Hz), sine	1070 A
$\int i^2 dt$	$T_{VJ} = 45^\circ\text{C}$ $V_R = 0$	t = 10 ms (50 Hz), sine	6600 A ² s
		t = 8.3 ms (60 Hz), sine	6280 A ² s
	$T_{VJ} = T_{VJM}$ $V_R = 0$	t = 10 ms (50 Hz), sine	5000 A ² s
		t = 8.3 ms (60 Hz), sine	4750 A ² s
$(di/dt)_{cr}$	$T_{VJ} = T_{VJM}$ f = 50 Hz, $t_p = 200 \mu\text{s}$ $V_D = 2/3 V_{DRM}$ $I_G = 0.45 \text{ A}$ $di_G/dt = 0.45 \text{ A}/\mu\text{s}$	repetitive, $I_T = 150 \text{ A}$	150 A/ μs
		non repetitive, $I_T = I_{TAVM}$	500 A/ μs
$(dv/dt)_{cr}$	$T_{VJ} = T_{VJM};$ $R_{GK} = \infty;$ method 1 (linear voltage rise)	$V_{DR} = 2/3 V_{DRM}$	1000 V/ μs
P_{GM}	$T_{VJ} = T_{VJM}$	$t_p = 30 \mu\text{s}$	10 W
	$I_T = I_{TAVM}$	$t_p = 300 \mu\text{s}$	5 W
P_{GAV}			0.5 W
V_{RGM}			10 V
T_{VJ}		-40...+125	°C
T_{VJM}		125	°C
T_{stg}		-40...+125	°C
V_{ISOL}	50/60 Hz, RMS	t = 1 min	3000 V~
	$I_{ISOL} \leq 1 \text{ mA}$	t = 1 s	3600 V~
M_d	Mounting torque (M5)	2.5-4.0/22-35	Nm/lb.in.
	Terminal connection torque (M5)	2.5-4.0/22-35	Nm/lb.in.
Weight	Typical including screws	90	g

TO-240 AA

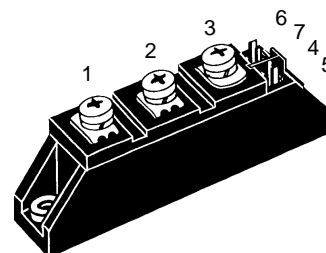

WPT 44

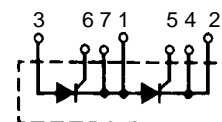

WPH 44

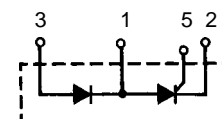

Features

- International standard package, JEDEC TO-240 AA
- Direct copper bonded Al_2O_3 -ceramic base plate
- Planar passivated chips
- Isolation voltage 3600 V~
- Gate-cathode twin pins for WPT

Applications

- DC motor control
- Softstart AC motor controller
- Light, heat and temperature control

Advantages

- Space and weight savings
- Simple mounting with two screws
- Improved temperature and power cycling
- Reduced protection circuits

Symbol	Test Conditions	Characteristic Values
I_{RRM}, I_{DRM}	$T_{VJ} = T_{VJM}; V_R = V_{RRM}; V_D = V_{DRM}$	5 mA
V_T, V_F	$I_T, I_F = 200 \text{ A}; T_{VJ} = 25^\circ\text{C}$	1.75 V
V_{T0}	For power-loss calculations only ($T_{VJ} = 125^\circ\text{C}$)	0.85 V
r_T		5.3 mΩ
V_{GT}	$V_D = 6 \text{ V}; T_{VJ} = 25^\circ\text{C}$	1.5 V
	$T_{VJ} = -40^\circ\text{C}$	1.6 V
I_{GT}	$V_D = 6 \text{ V}; T_{VJ} = 25^\circ\text{C}$	100 mA
	$T_{VJ} = -40^\circ\text{C}$	200 mA
V_{GD}	$T_{VJ} = T_{VJM}; V_D = 2/3 V_{DRM}$	0.2 V
I_{GD}		10 mA
I_L	$T_{VJ} = 25^\circ\text{C}; t_p = 10 \mu\text{s}; V_D = 6 \text{ V}$ $I_G = 0.45 \text{ A}; di_G/dt = 0.45 \text{ A}/\mu\text{s}$	450 mA
I_H	$T_{VJ} = 25^\circ\text{C}; V_D = 6 \text{ V}; R_{GK} = \infty$	200 mA
t_{gd}	$T_{VJ} = 25^\circ\text{C}; V_D = 1/2 V_{DRM}$ $I_G = 0.45 \text{ A}; di_G/dt = 0.45 \text{ A}/\mu\text{s}$	2 μs
t_q	$T_{VJ} = T_{VJM}; I_T = 120 \text{ A}; t_p = 200 \mu\text{s}; -di/dt = 10 \text{ A}/\mu\text{s}$ typ. $V_R = 100 \text{ V}; dv/dt = 20 \text{ V}/\mu\text{s}; V_D = 2/3 V_{DRM}$	150 μs
Q_S	$T_{VJ} = T_{VJM}; I_T, I_F = 50 \text{ A}; -di/dt = 0.64 \text{ A}/\mu\text{s}$	90 μC
I_{RM}		11 A
R_{thJC}	per thyristor/diode; DC current per module	0.53 K/W
R_{thJK}	per thyristor/diode; DC current per module	0.73 K/W
	other values see Fig. 8/9	0.265 K/W
		0.365 K/W
d_s	Creepage distance on surface	12.7 mm
d_A	Strike distance through air	9.6 mm
a	Maximum allowable acceleration	50 m/s ²

Optional accessories for module-type WPT

Keyed gate/cathode twin plugs with wire length = 350 mm, gate = yellow, cathode = red

Type **U9910** UL 758, style 1385,
CSA class 5851, guide 460-1-1

DataSheet4U.com

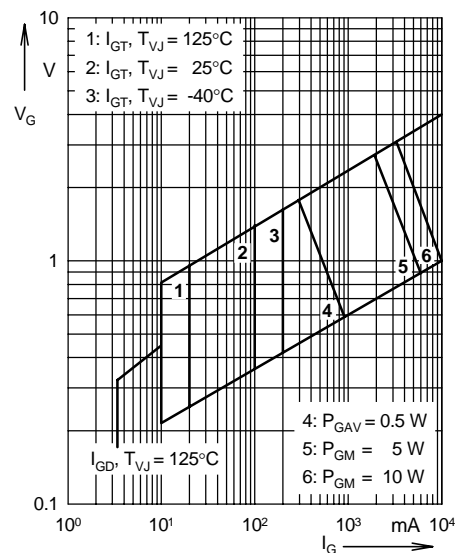

Fig. 1 Gate trigger characteristics

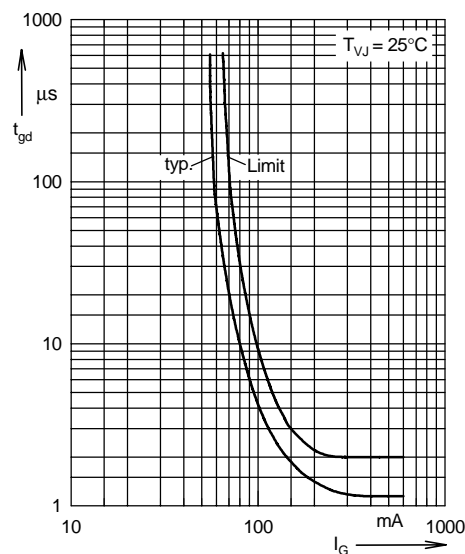
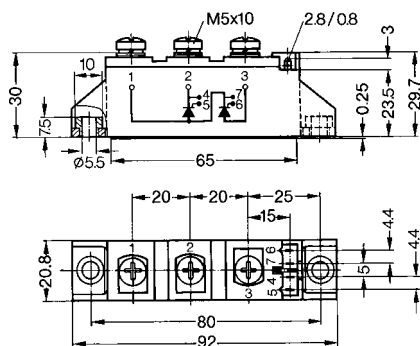

Fig. 2 Gate trigger delay time

Dimensions in mm (1 mm = 0.0394")

WPT 44



WPH 44

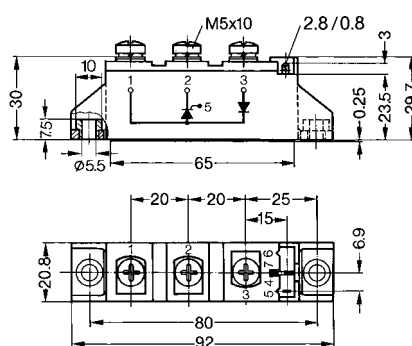

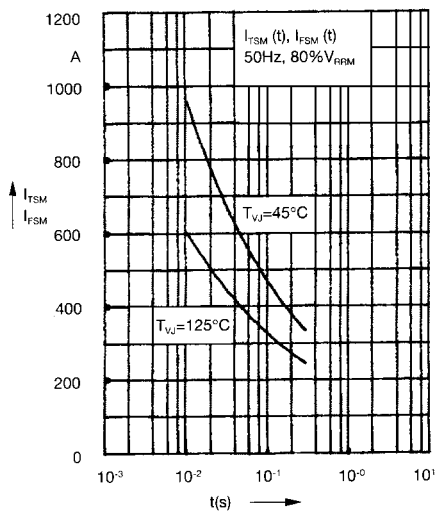

Fig. 3 Surge overload current
 I_{TSM} , I_{FSM} : Crest value, t : duration

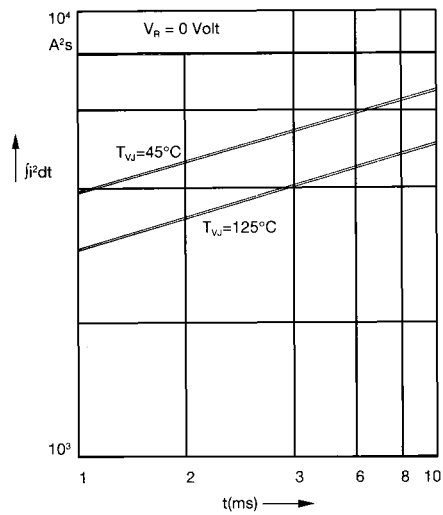

Fig. 4 $\int i^2 dt$ versus time (1-10 ms)

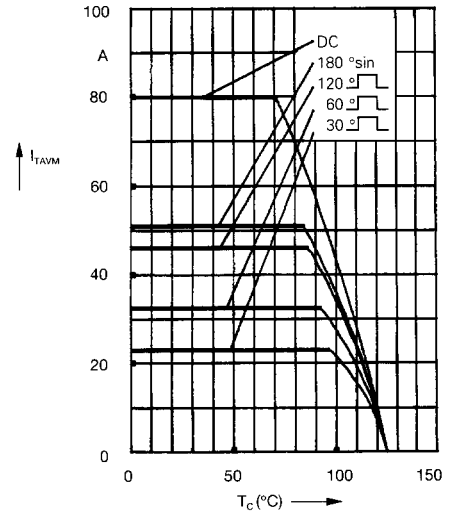

Fig. 4a Maximum forward current at case temperature

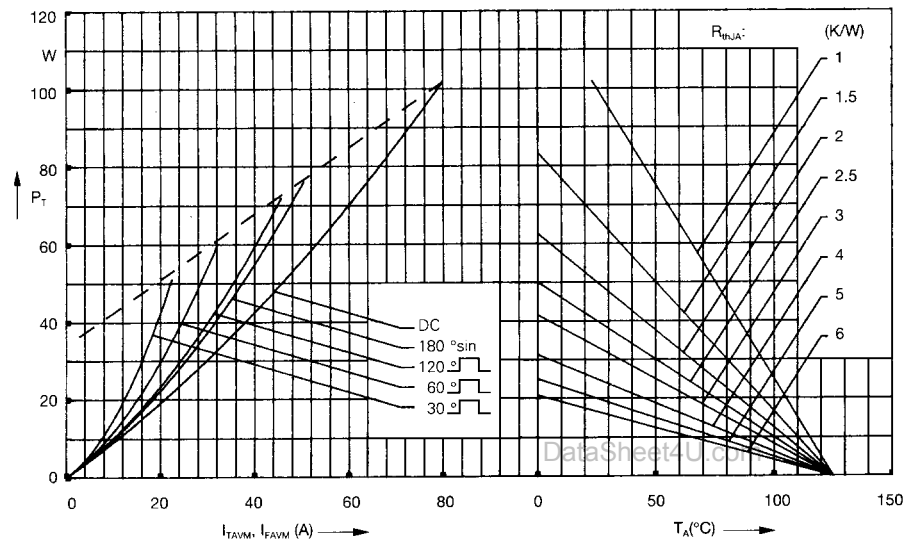

Fig. 5 Power dissipation versus on-state current and ambient temperature (per thyristor or diode)

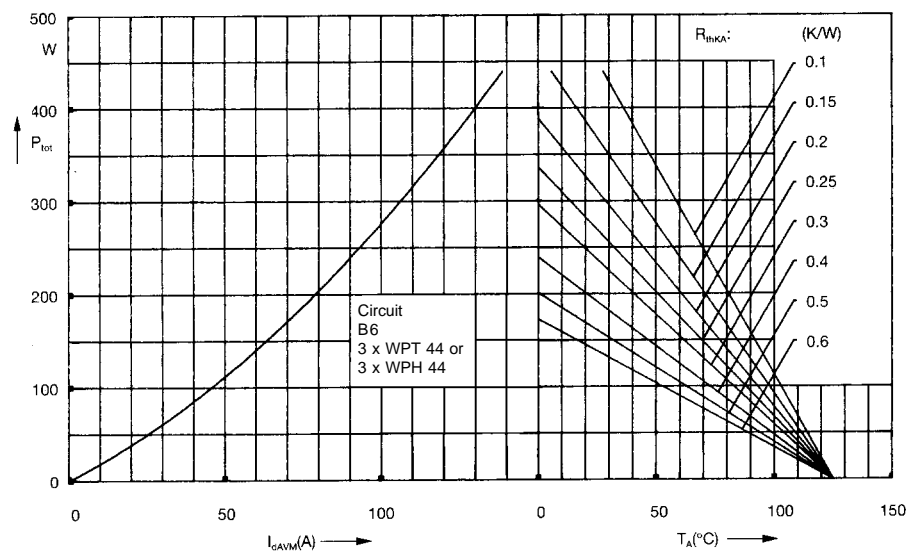

Fig. 6 Three phase rectifier bridge: Power dissipation versus direct output current and ambient temperature

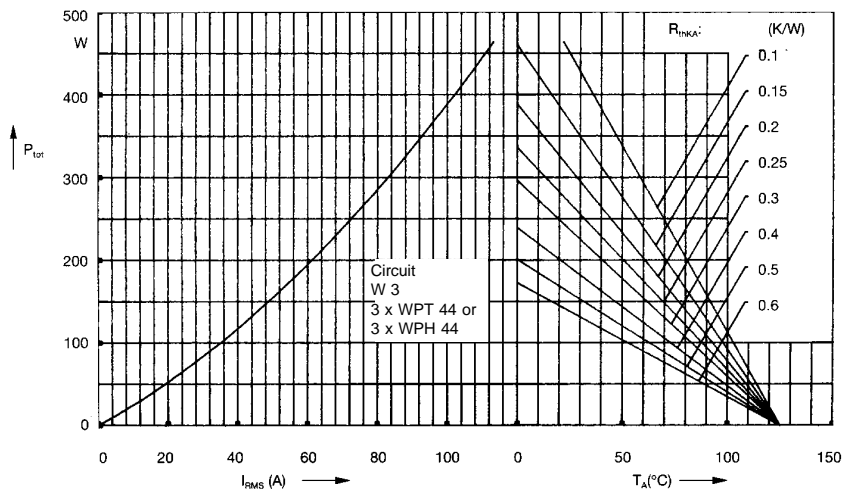

Fig. 7 Three phase AC-controller: Power dissipation versus RMS output current and ambient temperature

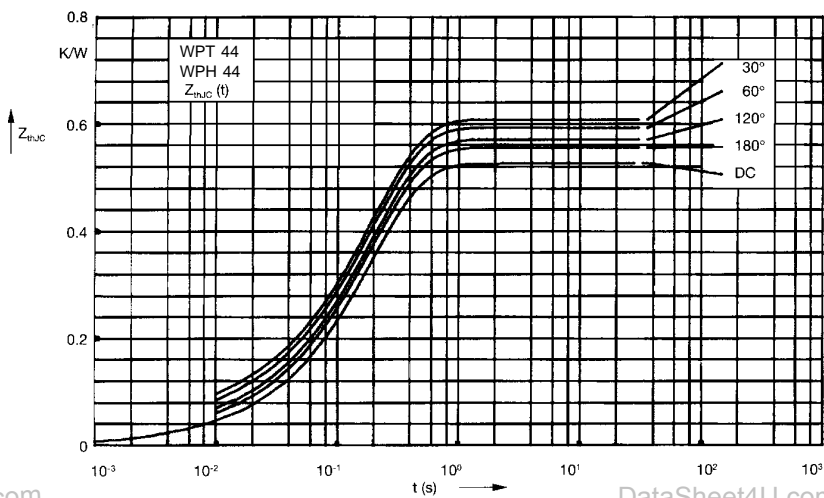

Fig. 8 Transient thermal impedance junction to case (per thyristor or diode)

R_{thJC} for various conduction angles d:

d	R_{thJC} (K/W)
DC	0.53
180°	0.55
120°	0.58
60°	0.6
30°	0.62

Constants for Z_{thJC} calculation:

i	R_{thi} (K/W)	t_i (s)
1	0.015	0.0035
2	0.026	0.02
3	0.489	0.195

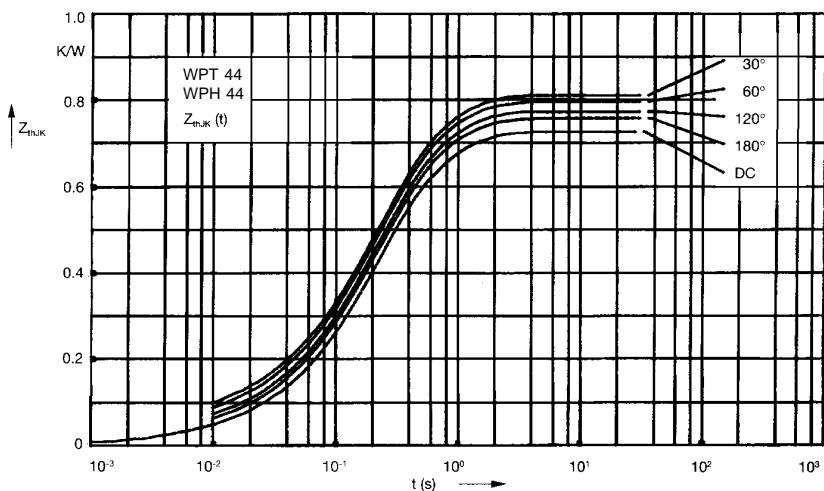

Fig. 9 Transient thermal impedance junction to heatsink (per thyristor or diode)

R_{thJK} for various conduction angles d:

d	R_{thJK} (K/W)
DC	0.73
180°	0.75
120°	0.78
60°	0.8
30°	0.82

Constants for Z_{thJK} calculation:

i	R_{thi} (K/W)	t_i (s)
1	0.015	0.0035
2	0.026	0.02
3	0.489	0.195
4	0.2	0.68

WESTCODE 
SEMICONDUCTORS

UK : Westcode Semiconductors Ltd
P.O. Box 97, Chippenham, Wiltshire, England SN15 1JL
Tel : +44 (0)1249 444524 Fax : +44 (0)1249 659448
E-Mail : WSL.sales@westcode.com

USA : Westcode Semiconductors Inc
3270 Cherry Avenue Long Beach, California 90807
Tel : 562 595 6971 Fax : 562 595 8182

WWW: <http://www.westcode.com>

In the interest of Product improvement Westcode reserves the right to change specifications at any time without notice.

© Westcode Semiconductors Ltd