

NCP803

Very Low Supply Current 3-Pin Microprocessor Reset Monitor

The NCP803 is a cost-effective system supervisor circuit designed to monitor V_{CC} in digital systems and provide a reset signal to the host processor when necessary. No external components are required.

The reset output is driven active within 10 μ sec of V_{CC} falling through the reset voltage threshold. Reset is maintained active for a minimum of 140 msec after V_{CC} rises above the reset threshold. The NCP803 has an open drain active-low $\overline{\text{RESET}}$ output. The output of the NCP803 is guaranteed valid down to $V_{CC} = 1.0$ V and is available in a SOT-23 package.

The NCP803 is optimized to reject fast transient glitches on the V_{CC} line. Low supply current of 1.0 μ A ($V_{CC} = 3.2$ V) make this device suitable for battery powered applications.

Features

- Precision V_{CC} Monitor for 2.5 V, 3.0 V, 3.3 V, and 5.0 V Supplies
- Precision Monitoring Voltages from 1.6 V to 4.9 V Available in 100 mV Steps
- 140 msec Guaranteed Minimum $\overline{\text{RESET}}$ Output Duration
- $\overline{\text{RESET}}$ Output Guaranteed to $V_{CC} = 1.0$ V
- Low 1.0 μ A Supply Current
- V_{CC} Transient Immunity
- Small SOT-23 Package
- No External Components
- Wide Operating Temperature: -40°C to 105°C
- Pb-Free Packages are Available

Typical Applications

- Computers
- Embedded Systems
- Battery Powered Equipment
- Critical μ P Power Supply Monitoring

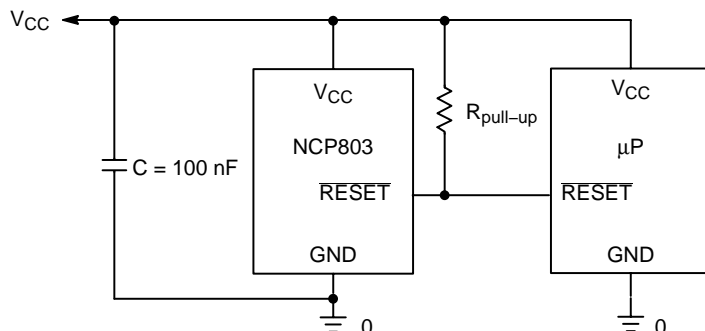

Figure 1. Typical Application Diagram



ON Semiconductor®

<http://onsemi.com>

MARKING DIAGRAM

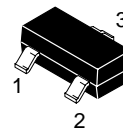

SOT-23
(TO-236)
CASE 318

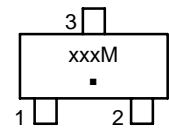

xxx = Specific Device Code
M = Date Code
■ = Pb-Free Package

PIN CONFIGURATION

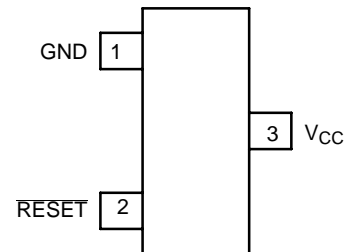

SOT-23
(Top View)

NOTE: SOT-23 is equivalent to JEDEC (TO-236)

ORDERING INFORMATION

Device	Package	Shipping†
NCP803SNxxxT1	SOT-23	3000/Tape & Reel
NCP803SNxxxT1G	SOT-23 (Pb-Free)	3000/Tape & Reel
NCP803SNxxxT3	SOT-23	10000/Tape & Reel
NCP803SNxxxT3G	SOT-23 (Pb-Free)	10000/Tape & Reel

†For information on tape and reel specifications, including part orientation and tape sizes, please refer to our Tape and Reel Packaging Specification Brochure, BRD8011/D.

NOTE: The "xxx" denotes a suffix for V_{CC} voltage threshold options – see page 5 for more details.

*The "T3" suffix refers to a 13 inch reel.

DEVICE MARKING INFORMATION

See general marking information in the device marking section on page 5 of this data sheet.

NCP803

PIN DESCRIPTION

Pin No.	Symbol	Description
1	GND	Ground
2	RESET	RESET output remains low while V _{CC} is below the reset voltage threshold, and for 240 msec (typ.) after V _{CC} rises above reset threshold.
3	V _{CC}	Supply Voltage: C = 100 nF is recommended as a bypass capacitor between V _{CC} and GND.

ABSOLUTE MAXIMUM RATINGS (Note 1)

Rating	Symbol	Value	Unit
Supply Voltage (V _{CC} to GND)	V _{CC}	6.0	V
RESET		-0.3 to (V _{CC} + 0.3)	V
Input Current, V _{CC}		20	mA
Output Current, RESET		20	mA
dV/dt (V _{CC})		100	V/μsec
Thermal Resistance, Junction to Air	R _{θJA}	491	°C/W
Operating Temperature Range	T _A	-40 to +105	°C
Storage Temperature Range	T _{stg}	-65 to +150	°C
Lead Temperature (Soldering, 10 Seconds)	T _{sol}	+260	°C
Latch-up performance:	I _{Latch-up}		mA
Negative		150	

Maximum ratings are those values beyond which device damage can occur. Maximum ratings applied to the device are individual stress limit values (not normal operating conditions) and are not valid simultaneously. If these limits are exceeded, device functional operation is not implied, damage may occur and reliability may be affected.

- This device series contains ESD protection and exceeds the following tests:
Human Body Model 4000 V per MIL-STD-883, Method 3015.
Machine Model Method 400 V.
- The maximum package power dissipation limit must not be exceeded.

$$P_D = \frac{T_{J(max)} - T_A}{R_{\theta JA}} \quad \text{with } T_{J(max)} = 150^\circ\text{C}$$

NCP803

ELECTRICAL CHARACTERISTICS $T_A = -40^\circ\text{C}$ to $+105^\circ\text{C}$ unless otherwise noted. Typical values are at $T_A = +25^\circ\text{C}$. (Note 3)

Characteristic	Symbol	Min	Typ	Max	Unit
V _{CC} Range T _A = 0°C to +70°C T _A = -40°C to +105°C		1.0 1.2	– –	5.5 5.5	V
Supply Current V _{CC} = 3.3 V T _A = -40°C to +85°C T _A = 85°C to +105°C V _{CC} = 5.5 V T _A = -40°C to +85°C T _A = 85°C to +105°C	I _{CC}	– – – –	0.5 – 0.8 –	1.2 2.0 1.8 2.5	μA
Reset Threshold (Note 4)	V _{TH}				V
NCP803SN463 T _A = +25°C T _A = -40°C to +85°C T _A = +85°C to +105°C		4.56 4.51 4.40	4.63 – –	4.70 4.75 4.88	
NCP803SN438 T _A = +25°C T _A = -40°C to +85°C T _A = +85°C to +105°C		4.31 4.27 4.16	4.38 – –	4.45 4.49 4.60	
NCP803SN308 T _A = +25°C T _A = -40°C to +85°C T _A = +85°C to +105°C		3.04 3.00 2.92	3.08 – –	3.11 3.15 3.23	
NCP803SN293 T _A = +25°C T _A = -40°C to +85°C T _A = +85°C to +105°C		2.89 2.85 2.78	2.93 – –	2.96 3.00 3.08	
NCP803SN263 T _A = +25°C T _A = -40°C to +85°C T _A = +85°C to +105°C		2.59 2.55 2.50	2.63 – –	2.66 2.70 2.76	
NCP803SN232 T _A = +25°C T _A = -40°C to +85°C T _A = +85°C to +105°C		2.29 2.26 2.20	2.32 – –	2.35 2.38 2.45	
NCP803SN160 T _A = +25°C T _A = -40°C to +85°C T _A = +85°C to +105°C		1.58 1.56 1.52	1.60 – –	1.62 1.64 1.68	
Reset Temperature Coefficient		–	30	–	ppm/°C
V _{CC} to Reset Delay V _{CC} = V _{TH} to (V _{TH} – 100 mV)		–	10	–	μsec
Reset Active Timeout Period		140	240	460	msec
RESET Output Voltage Low V _{CC} = V _{TH} – 0.2 V 1.6 V ≤ V _{TH} ≤ 2.0 V, I _{SINK} = 0.5 mA 2.1 V ≤ V _{TH} ≤ 4.0 V, I _{SINK} = 1.2 mA 4.1 V ≤ V _{TH} ≤ 4.9 V, I _{SINK} = 3.2 mA	V _{OL}	–	–	0.3	V
RESET Leakage Current V _{CC} > V _{TH} , RESET De-asserted	I _{LEAK}	–	–	1	μA

3. Production testing done at T_A = 25°C, over temperature limits guaranteed by design.

4. Contact your ON Semiconductor sales representative for other threshold voltage options.

TYPICAL CHARACTERISTICS

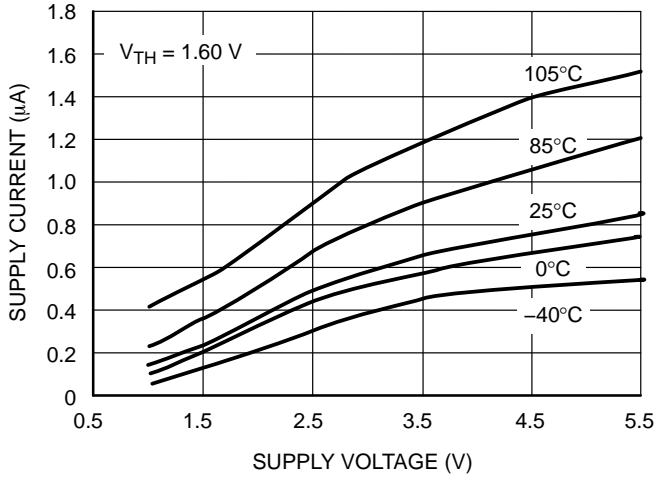

Figure 2. Supply Current vs. Supply Voltage

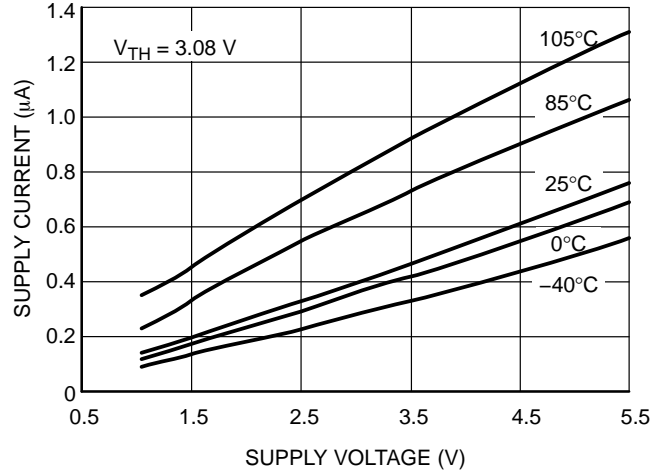

Figure 3. Supply Current vs. Supply Voltage

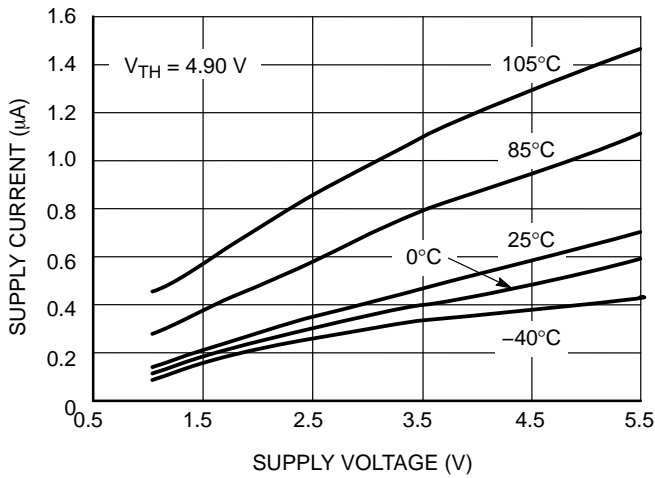

Figure 4. Supply Current vs. Supply Voltage

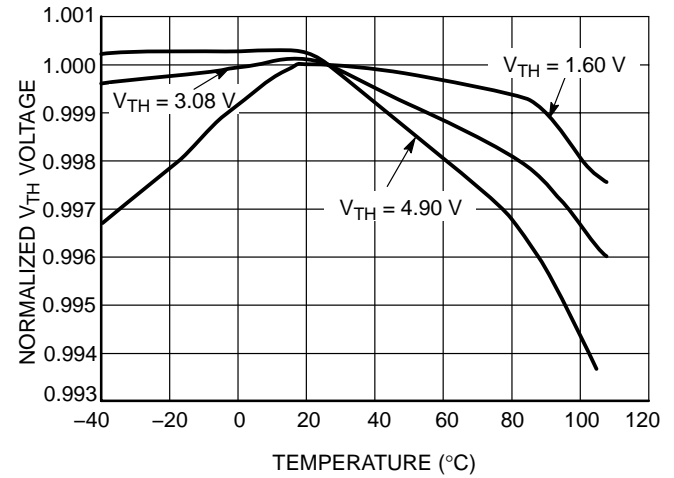

Figure 5. Normalized Reset Threshold Voltage vs. Temperature

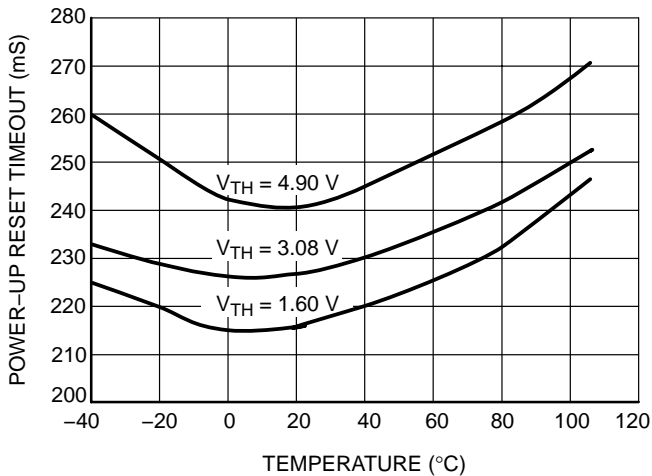

Figure 6. Power-up Reset Timeout vs. Temperature

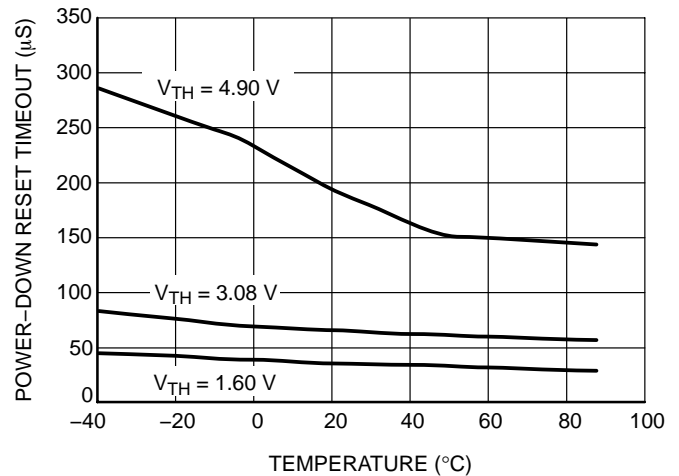
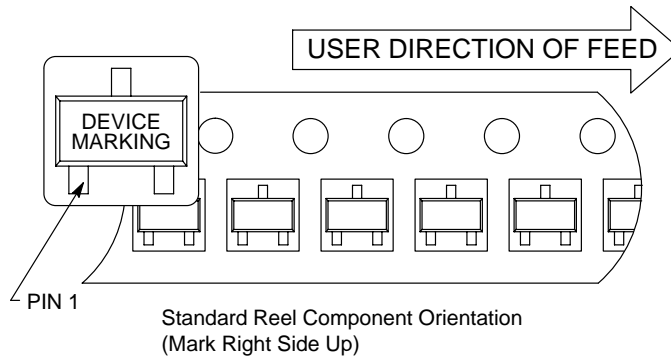

Figure 7. Power-down Reset Timeout vs. Temperature (Overdrive = 20 mV)

NCP803

TAPING FORM

Component Taping Orientation for 3L SOT-23 (JEDEC-236) Devices



Tape & Reel Specifications Table

Package	Carrier Width (W)	Pitch (P)	Part Per Full Reel	Reel Size
SOT-23	8 mm	4 mm	3000	7 inches
SOT-23	8 mm	4 mm	10000	13 inches

MARKING AND THRESHOLD INFORMATION

ON Semiconductor Part #	V_{TH}^*	Marking (Note 5)
NCP803SN160T1	1.60	SCQM
NCP803SN160T1G	1.60	SCQM
NCP803SN232T1	2.32	SQRM
NCP803SN232T1G	2.32	SQRM
NCP803SN263T1	2.63	SQCM
NCP803SN263T1G	2.63	SQCM
NCP803SN293T1	2.93	SQDM
NCP803SN293T1G	2.93	SQDM
NCP803SN293T3	2.93	SQDM
NCP803SN293T3G	2.93	SQDM
NCP803SN308T1	3.08	SQEM
NCP803SN308T1G	3.08	SQEM
NCP803SN438T1	4.38	SQFM
NCP803SN438T1G	4.38	SQFM
NCP803SN463T1	4.63	SQGM
NCP803SN463T1G	4.63	SQGM

NOTE: The "G" suffix indicates Pb-Free package available.

*Contact your ON Semiconductor sales representative for other threshold voltage options.

5. M = Monthly Date Code

NCP803

PACKAGE DIMENSIONS

SOT-23 (TO-236)
CASE 318-08
ISSUE AL

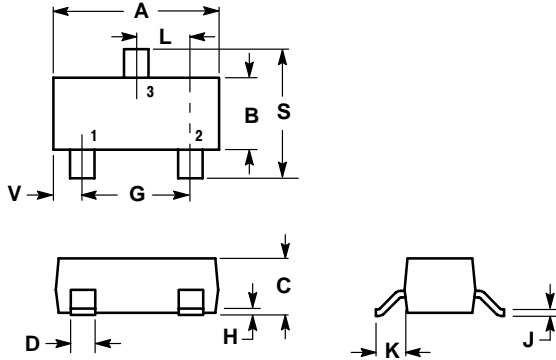

NOTES:

1. DIMENSIONING AND TOLERANCING PER ANSI Y14.5M, 1982.
2. CONTROLLING DIMENSION: INCH.
3. MAXIMUM LEAD THICKNESS INCLUDES LEAD FINISH THICKNESS. MINIMUM LEAD THICKNESS IS THE MINIMUM THICKNESS OF BASE MATERIAL.
4. 318-01 THRU -07 AND -09 OBSOLETE, NEW STANDARD 318-08.

DIM	INCHES		MILLIMETERS	
	MIN	MAX	MIN	MAX
A	0.1102	0.1197	2.80	3.04
B	0.0472	0.0551	1.20	1.40
C	0.0350	0.0440	0.89	1.11
D	0.0150	0.0200	0.37	0.50
G	0.0701	0.0807	1.78	2.04
H	0.0005	0.0040	0.013	0.100
J	0.0034	0.0070	0.085	0.177
K	0.0140	0.0285	0.35	0.69
L	0.0350	0.0401	0.89	1.02
S	0.0830	0.1039	2.10	2.64
V	0.0177	0.0236	0.45	0.60

STYLE 8:

- PIN 1. ANODE
- 2. NO CONNECTION
- 3. CATHODE

SOLDERING FOOTPRINT*

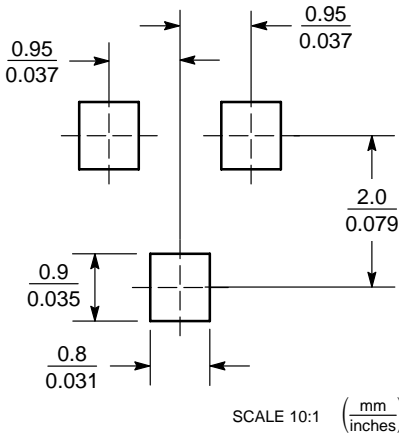

*For additional information on our Pb-Free strategy and soldering details, please download the ON Semiconductor Soldering and Mounting Techniques Reference Manual, SOLDERRM/D.

ON Semiconductor and  are registered trademarks of Semiconductor Components Industries, LLC (SCILLC). SCILLC reserves the right to make changes without further notice to any products herein. SCILLC makes no warranty, representation or guarantee regarding the suitability of its products for any particular purpose, nor does SCILLC assume any liability arising out of the application or use of any product or circuit, and specifically disclaims any and all liability, including without limitation special, consequential or incidental damages. "Typical" parameters which may be provided in SCILLC data sheets and/or specifications can and do vary in different applications and actual performance may vary over time. All operating parameters, including "Typicals" must be validated for each customer application by customer's technical experts. SCILLC does not convey any license under its patent rights nor the rights of others. SCILLC products are not designed, intended, or authorized for use as components in systems intended for surgical implant into the body, or other applications intended to support or sustain life, or for any other application in which the failure of the SCILLC product could create a situation where personal injury or death may occur. Should Buyer purchase or use SCILLC products for any such unintended or unauthorized application, Buyer shall indemnify and hold SCILLC and its officers, employees, subsidiaries, affiliates, and distributors harmless against all claims, costs, damages, and expenses, and reasonable attorney fees arising out of, directly or indirectly, any claim of personal injury or death associated with such unintended or unauthorized use, even if such claim alleges that SCILLC was negligent regarding the design or manufacture of the part. SCILLC is an Equal Opportunity/Affirmative Action Employer. This literature is subject to all applicable copyright laws and is not for resale in any manner.

PUBLICATION ORDERING INFORMATION

LITERATURE FULFILLMENT:
Literature Distribution Center for ON Semiconductor
P.O. Box 61312, Phoenix, Arizona 85082-1312 USA
Phone: 480-829-7710 or 800-344-3860 Toll Free USA/Canada
Fax: 480-829-7709 or 800-344-3867 Toll Free USA/Canada
Email: orderlit@onsemi.com

N. American Technical Support: 800-282-9855 Toll Free USA/Canada

Japan: ON Semiconductor, Japan Customer Focus Center
2-9-1 Kamimeguro, Meguro-ku, Tokyo, Japan 153-0051
Phone: 81-3-5773-3850

ON Semiconductor Website: <http://onsemi.com>

Order Literature: <http://www.onsemi.com/litorder>

For additional information, please contact your local Sales Representative.