

GSC2146

600mA CMOS Positive Voltage Regulator

Description

The GSC2146 series of positive, linear regulators feature low quiescent current (30µA typ.) with low dropout voltage, making them ideal for battery applications. The space-saving SOP-8 package is attractive for "Pocket" and "Hand Held" applications.

These rugged devices have both Thermal Shutdown, and Current Fold-back to prevent device failure under the "Worst" of operating conditions.

In applications requiring a low noise, regulated supply, place a 1000pF capacitor between Bypass and ground. The GSC2146 is stable with an output capacitance of 2.2µF or greater.

Features

- Very Low Dropout Voltage
- Guaranteed 600mA output
- Over-Temperature Shutdown
- Current Limiting
- Short Circuit Current Fold-back
- Factory Pre-set Output Voltage
- Highly Accurate ± 1.5%
- Noise Reduction Bypass Capacitor
- Low Temperature Coefficient

Applications

- Battery Powered Widgets
- Instrumentation
- Wireless Devices
- Cordless Phones
- PC Peripherals
- Portable Electronics
- Electronic Scales

Package Dimensions

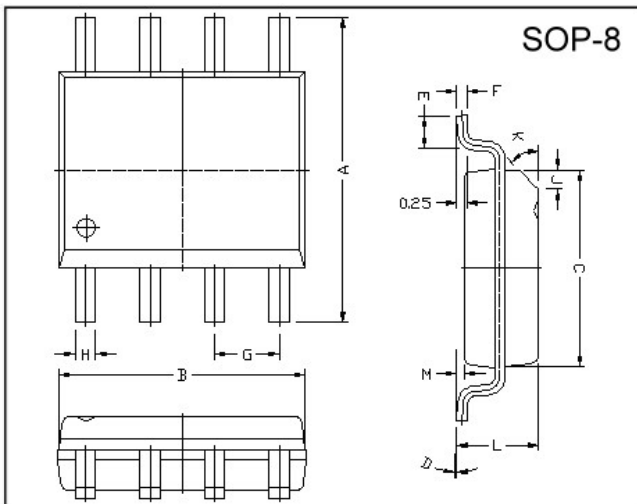

Block Diagram

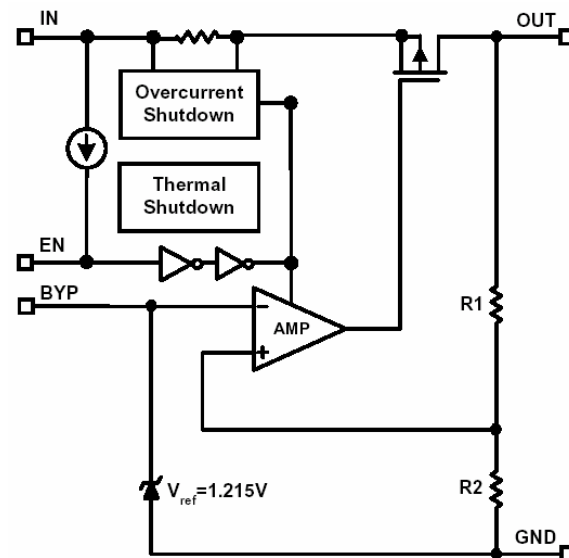

Marking :

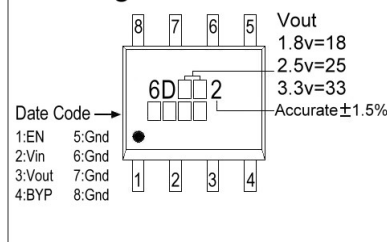

REF.	Millimeter		REF.	Millimeter	
	Min.	Max.		Min.	Max.
A	5.80	6.20	M	0.10	0.25
B	4.80	5.00	H	0.35	0.49
C	3.80	4.00	L	1.35	1.75
D	0°	8°	J	0.375 REF.	
E	0.40	0.90	K	45°	
F	0.19	0.25	G	1.27 TYP.	

Typical Application Circuit

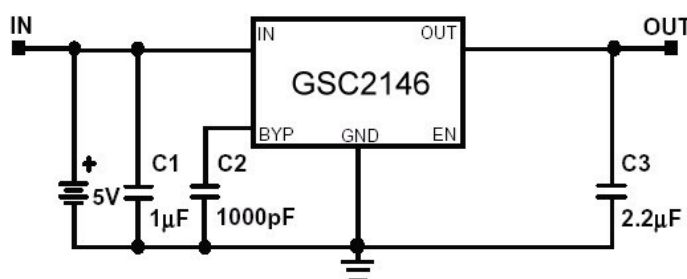

Absolute Maximum Ratings

Parameter	Symbol	Ratings	Unit
Input Max Voltage	V _{IN}	8	V
Output Current	I _{OUT}	PD/(V _{IN} -V _O)	A
Output Voltage	V _{OUT}	1.5~3.8	V
Operating Ambient Temperature	T _{opr}	-40 ~ +85	°C
Junction Temperature	T _j	-40 ~ +125	°C
Maximum Junction Temperature	T _{j Max}	150	°C
Thermal Resistance	θ _{ja}	123.7	°C/W
Power Dissipation(ΔT=100°C)	PD	810	mW
EDS Classification		B	

Electrical Characteristics Ta=25°C unless otherwise noted

Parameter	Symbol	Condition	Min	TYP	Max	Unit	
Output Voltage	V _{OUT(E)} (Note1)	V _{IN} =V _{OUT(T)} +2V, I _O =1mA	-1.5%	V _{OUT(T)} (Note2)	1.5%	V	
Output Current	I _O	V _{IN} =V _{OUT(T)} +2V, V _O >1.2V	600	-	-	mA	
Current Limit	I _{LIM}	V _{IN} =V _{OUT(T)} +2V, V _O >1.2V	600	800	-	mA	
Load Regulation	REG _{LOAD}	V _{IN} =V _{OUT(T)} +2V, I _O =1mA to 600mA	-	0.2	1	%	
Dropout Voltage	V _{DROPOUT}	I _O =600mA V _O =V _{OUT(E)} -2%	1.3V ≤ V _{OUT(T)} ≤ 1.4V	-	-	1900	mV
			1.4V < V _{OUT(T)} ≤ 2.0V	-	-	1400	
			2.0V < V _{OUT(T)} ≤ 2.8V	-	-	800	
			2.8V < V _{OUT(T)}	-	-	600	
Quiescent Current	I _Q	V _{IN} =V _{OUT(T)} +1V, I _O =0mA	-	30	50	μA	
Line Regulation	REG _{LINE}	I _O =1mA V _{IN} =V _{OUT(T)} +1 to V _{OUT(T)} +2	1.3V ≤ V _{OUT(T)} ≤ 1.4V	-0.2	-	0.2	%
			1.4V < V _{OUT(T)} ≤ 2.0V	-0.15	-	0.15	
			2.0V < V _{OUT(T)}	-0.1	0.02	0.1	
Input Voltage	V _{IN}		Note3	-	7	V	
Over Temperature Shutdown	OTS		-	150	-	°C	
Over Temperature Hysteresis	OTH		-	30	-	°C	
Output Voltage Temperature Coefficient	TC		-	30	-	ppm/°C	
Short Circuit Current(Note4)	I _{SC}	V _{IN} =V _{OUT(T)} +1V, V _{OUT} <0.8V	-	300	600	mA	
Power Supply Rejection	PSRR	I _O =100mA C _O =2.2μF ceramic C _{BYP} =0.01μF	f=1kHz	-	75	-	dB
			f=10kHz	-	55	-	
			f=100kHz	-	30	-	
Output Voltage Noise	e _N	f=10Hz~100kHz I _O =10mA, C _{BYP} =0.01μF		30	-	μVrms	
EN Input Threshold	V _{EH}	V _{IN} =2.7V to 7V	2.0	-	V _{IN}	V	
	V _{EL}	V _{IN} =2.7V to 7V	0	-	0.4	V	
EN Input Bias Current	I _{EH}	V _{EN} =V _{IN} , V _{IN} =2.7V to 7V	-	-	0.1	μA	
	I _{EL}	V _{EN} =0V, V _{IN} =2.7V to 7V	-	-	0.5	μA	
Shutdown Supply Current	I _{SD}	V _{IN} =5V, V _O =0V, V _{EN} <V _{EL}	-	0.5	0.1	μA	

Note 1: V_{OUT(E)} =Effective Output Voltage (i.e. the output voltage when "V_{OUT(T)} + 2.0V" is provided at the V_{IN} pin while maintaining a certain I_{OUT} value).

2: V_{OUT(T)} =Specified Output Voltage

3: V_{IN(MIN)} =V_{OUT}+V_{DROPOUT}

4: To prevent the Short Circuit Current protection feature from being prematurely activated, the input voltage must be applied before a current source load is applied.

Ordering Information (contd.)

Part Number	Marking	Output Voltage	Part Number	Marking	Output Voltage
GSC2146-15	6D152 XXXX	1.5V	GSC2146-18	6D182 XXXX	1.8V
GSC2146-25	6D252 XXXX	2.5V	GSC2146-27	6D272 XXXX	2.7V
GSC2146-28	6D282 XXXX	2.8V	GSC2146-2H	6D2H2 XXXX	2.85V
GSC2146-29	6D292 XXXX	2.9V	GSC2146-30	6D302 XXXX	3.0V
GSC2146-31	6D312 XXXX	3.1V	GSC2146-33	6D332 XXXX	3.3V
GSC2146-34	6D342 XXXX	3.4V	GSC2146-35	6D352 XXXX	3.5V
GSC2146-36	6D362 XXXX	3.6V	GSC2146-37	6D372 XXXX	3.7V
GSC2146-38	6D382 XXXX	3.8V			

Detailed Description

The GSC2146 series of COMS regulators contain a PMOS pass transistor, voltage reference, error amplifier, over-current protection, and thermal shutdown.

The P-channel pass transistor receives data from the error amplifier, over-current shutdown, and thermal protection circuits. During normal operation, the error amplifier compares the output voltage to a precision reference. Over-current and Thermal shutdown circuits become active when the junction temperature exceeds 150°C, or the current exceeds 600mA. During thermal shutdown, the output voltage remains low. Normal operation is restored when the junction temperature drops below 120°C.

The GSC2146 switches from voltage mode to current mode when the load exceeds the rated output current. This prevents over-stress. The GSC2146 also incorporates current fold-back to reduce power dissipation when the output is short circuited. This feature becomes active when the output drops below 0.8 volts, and reduces the current flow by 65%. Full current is restored when the voltage exceeds 0.8 volts.

External Capacitors

The GSC2146 is stable with an output capacitance to ground of 2.2µF or greater. Ceramic capacitors have the lowest ESR, and will offer the best AC performance. Conversely, Aluminum Electrolytic capacitors exhibit the highest ESR, resulting in the poorest AC response. Unfortunately, large value ceramic capacitors are comparatively expensive. One option is to parallel a 0.1µF ceramic capacitor with a 10µF Aluminum Electrolytic. The benefit is low ESR, high capacitance, and low overall cost.

A second capacitor is recommended between the input and ground to stabilize V_{IN} . The input capacitor should be at least 0.1µF to have a beneficial effect.

A third capacitor can be connected between the BY-PASS pin and GND. This capacitor can be a low cost Polyester Film variety between the value of 0.001~0.01µF. A large capacitor improves the AC ripple rejection, but also makes the output come up slowly. This "Soft" turn-on is desirable in some applications to limit turn-on surges.

All capacitors should be placed in close proximity to the pins. A "Quiet" ground termination is desirable. This can be achieved with a "Star" connection.

Enable

The Enable pin normally floats high. When actively, pulled low, the PMOS pass transistor shuts off, and all internal circuits are powered down. In this state, the quiescent current is less than 1µA. This pin behaves much like an electronic switch.

Characteristics Curve

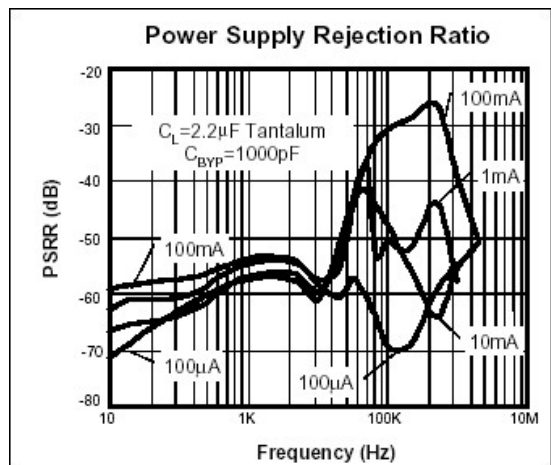
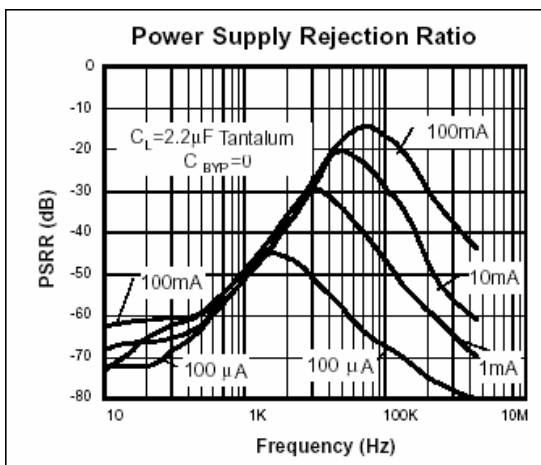
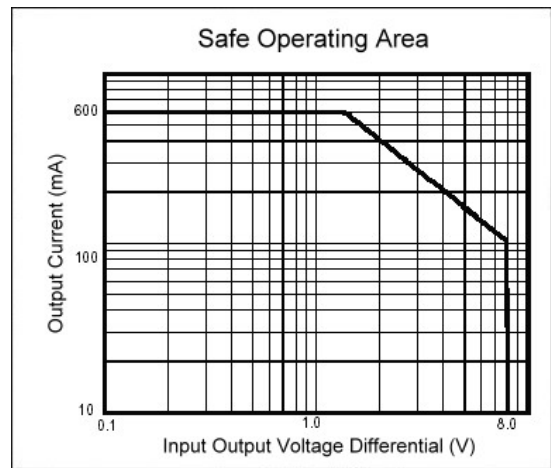
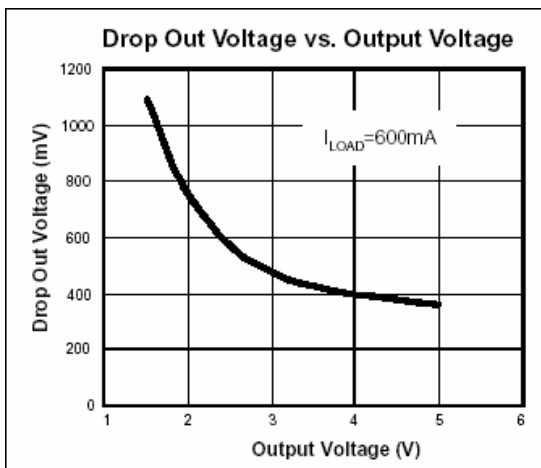
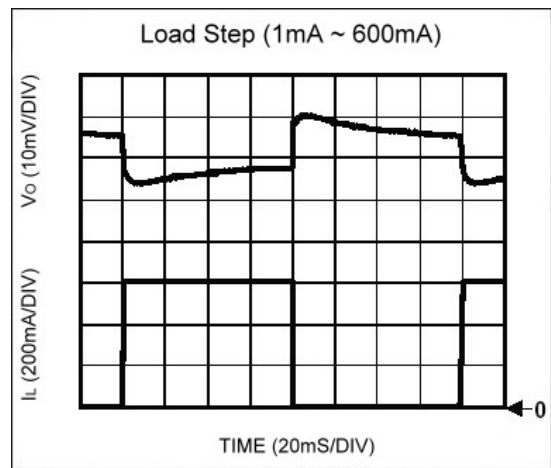
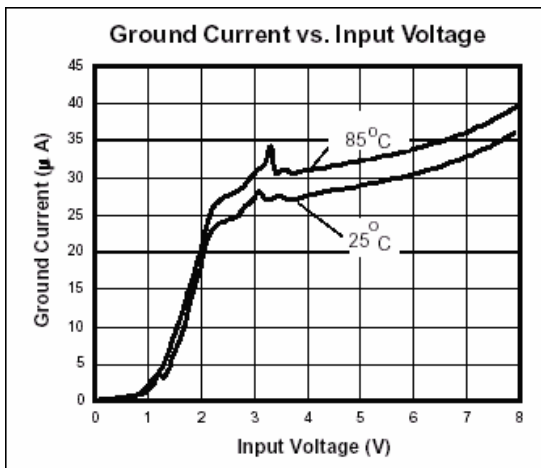

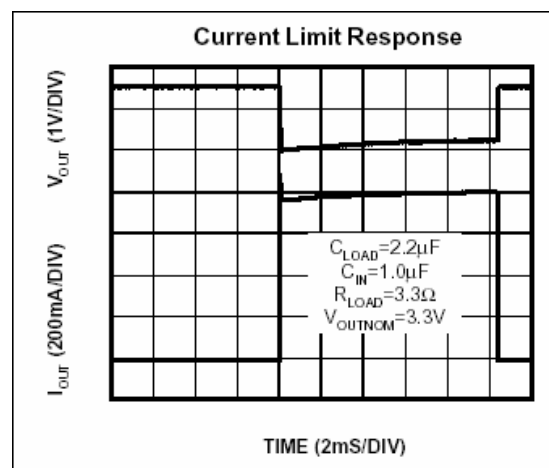
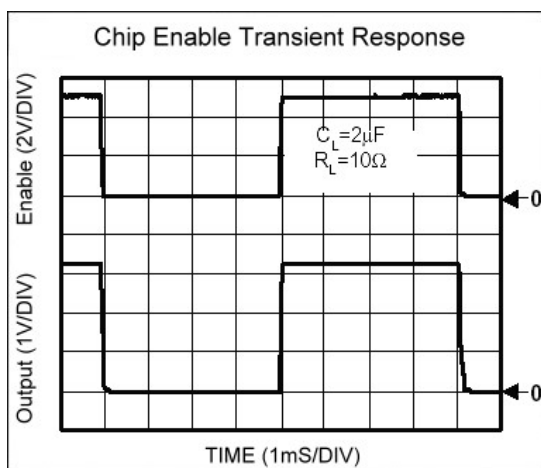
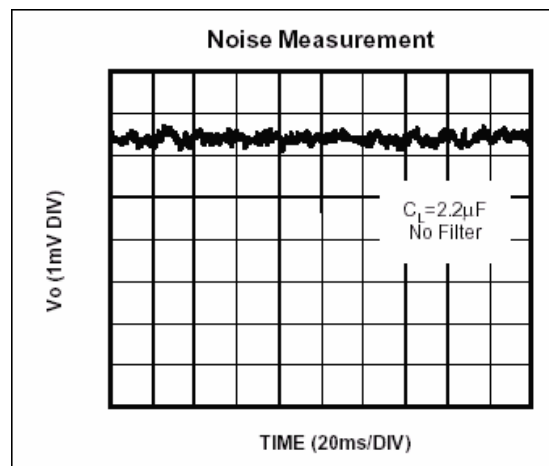
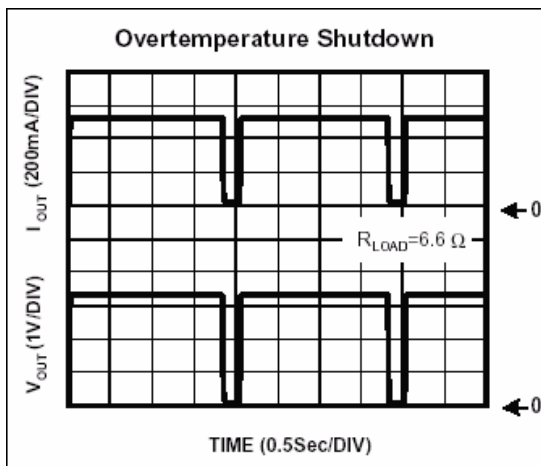
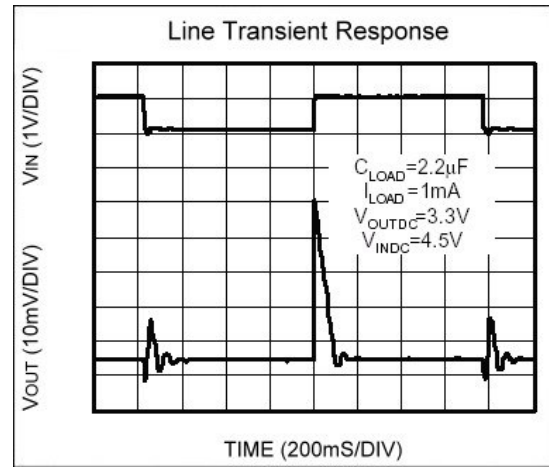
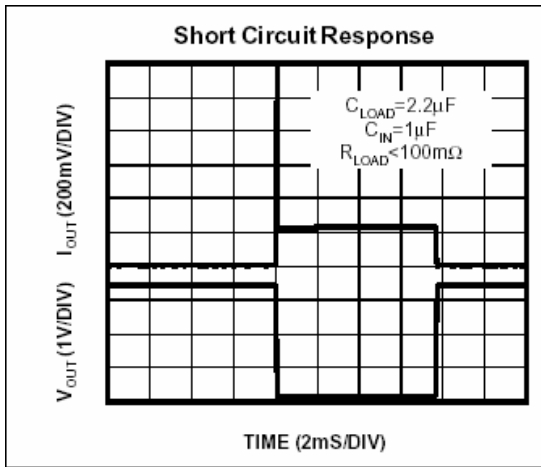

Important Notice:

- All rights are reserved. Reproduction in whole or in part is prohibited without the prior written approval of GTM.
- GTM reserves the right to make changes to its products without notice.
- GTM semiconductor products are not warranted to be suitable for use in life-support Applications, or systems.
- GTM assumes no liability for any consequence of customer product design, infringement of patents, or application assistance.

Head Office And Factory:

- Taiwan:** No. 17-1 Tatung Rd. Fu Kou Hsin-Chu Industrial Park, Hsin-Chu, Taiwan, R. O. C.
- TEL : 886-3-597-7061 FAX : 886-3-597-9220, 597-0785
- China:** (201203) No.255, Jang-Jiang Tsai-Lueng RD. , Pu-Dung-Hsin District, Shang-Hai City, China
- TEL : 86-21-5895-7671 ~ 4 FAX : 86-21-38950165